



# White Paper on Charging Deployment Scenarios

Approved – 04 Sep 2007

---

**Open Mobile Alliance**

OMA-WP-Charging\_Deployment\_Scenarios-20070904-A

Use of this document is subject to all of the terms and conditions of the Use Agreement located at <http://www.openmobilealliance.org/UseAgreement.html>.

Unless this document is clearly designated as an approved specification, this document is a work in process, is not an approved Open Mobile Alliance™ specification, and is subject to revision or removal without notice.

You may use this document or any part of the document for internal or educational purposes only, provided you do not modify, edit or take out of context the information in this document in any manner. Information contained in this document may be used, at your sole risk, for any purposes. You may not use this document in any other manner without the prior written permission of the Open Mobile Alliance. The Open Mobile Alliance authorizes you to copy this document, provided that you retain all copyright and other proprietary notices contained in the original materials on any copies of the materials and that you comply strictly with these terms. This copyright permission does not constitute an endorsement of the products or services. The Open Mobile Alliance assumes no responsibility for errors or omissions in this document.

Each Open Mobile Alliance member has agreed to use reasonable endeavors to inform the Open Mobile Alliance in a timely manner of Essential IPR as it becomes aware that the Essential IPR is related to the prepared or published specification. However, the members do not have an obligation to conduct IPR searches. The declared Essential IPR is publicly available to members and non-members of the Open Mobile Alliance and may be found on the “OMA IPR Declarations” list at <http://www.openmobilealliance.org/ipr.html>. The Open Mobile Alliance has not conducted an independent IPR review of this document and the information contained herein, and makes no representations or warranties regarding third party IPR, including without limitation patents, copyrights or trade secret rights. This document may contain inventions for which you must obtain licenses from third parties before making, using or selling the inventions. Defined terms above are set forth in the schedule to the Open Mobile Alliance Application Form.

NO REPRESENTATIONS OR WARRANTIES (WHETHER EXPRESS OR IMPLIED) ARE MADE BY THE OPEN MOBILE ALLIANCE OR ANY OPEN MOBILE ALLIANCE MEMBER OR ITS AFFILIATES REGARDING ANY OF THE IPR'S REPRESENTED ON THE “OMA IPR DECLARATIONS” LIST, INCLUDING, BUT NOT LIMITED TO THE ACCURACY, COMPLETENESS, VALIDITY OR RELEVANCE OF THE INFORMATION OR WHETHER OR NOT SUCH RIGHTS ARE ESSENTIAL OR NON-ESSENTIAL.

THE OPEN MOBILE ALLIANCE IS NOT LIABLE FOR AND HEREBY DISCLAIMS ANY DIRECT, INDIRECT, PUNITIVE, SPECIAL, INCIDENTAL, CONSEQUENTIAL, OR EXEMPLARY DAMAGES ARISING OUT OF OR IN CONNECTION WITH THE USE OF DOCUMENTS AND THE INFORMATION CONTAINED IN THE DOCUMENTS.

© 2007 Open Mobile Alliance Ltd. All Rights Reserved.

Used with the permission of the Open Mobile Alliance Ltd. under the terms set forth above.

# Contents

<b>1. SCOPE</b> .....	<b>5</b>
<b>2. REFERENCES</b> .....	<b>6</b>
<b>2.1 NORMATIVE REFERENCES</b> .....	<b>6</b>
<b>2.2 INFORMATIVE REFERENCES</b> .....	<b>6</b>
<b>3. TERMINOLOGY AND CONVENTIONS</b> .....	<b>7</b>
<b>3.1 CONVENTIONS</b> .....	<b>7</b>
<b>3.2 DEFINITIONS</b> .....	<b>7</b>
<b>3.3 ABBREVIATIONS</b> .....	<b>8</b>
<b>4. INTRODUCTION</b> .....	<b>9</b>
<b>5. DEPLOYMENTS (INFORMATIVE)</b> .....	<b>10</b>
<b>5.1 ENTITIES IN THE DEPLOYMENTS</b> .....	<b>10</b>
5.1.1 Charging Enabler User.....	10
5.1.2 Online Charging.....	10
5.1.3 Offline Charging.....	11
5.1.4 Charging Agent.....	11
<b>5.2 REFERENCE POINTS</b> .....	<b>11</b>
5.2.1 R-1 - Charging Enabler User – Offline Charging.....	11
5.2.2 R-2 - Charging Enabler User – Online Charging.....	11
5.2.3 R-3 - Charging Enabler User – Charging Agent.....	11
5.2.4 R-4 - Charging Agent – Offline Charging.....	11
5.2.5 R-5 - Charging Agent – Online Charging.....	12
<b>5.3 DEPLOYMENT-RELATED FUNCTIONAL COMPONENTS</b> .....	<b>12</b>
5.3.1 Translation.....	12
5.3.2 Relay.....	12
<b>5.4 TRIGGERING OF CHARGING EVENTS</b> .....	<b>12</b>
5.4.1 Triggering in an Enabler Implementation.....	13
5.4.2 Triggering in an Application.....	14
5.4.3 Triggering in the Policy Enforcer.....	15
5.4.4 Triggering in the Underlying Network.....	16
<b>5.5 BASIC SCENARIO</b> .....	<b>17</b>
<b>5.6 CHARGING AGENT SCENARIO</b> .....	<b>18</b>
<b>5.7 CHARGING AGENT SCENARIO WITH PARALLEL CHARGING ENABLER USERS</b> .....	<b>21</b>
<b>6. FLOWS</b> .....	<b>23</b>
<b>6.1 BASIC SCENARIO</b> .....	<b>24</b>
6.1.1 Offline (Basic).....	24
6.1.2 Offline (Advanced).....	25
6.1.3 Online (Basic).....	26
6.1.4 Online (Refund).....	27
<b>6.2 AGENT SCENARIO</b> .....	<b>28</b>
6.2.1 Offline.....	28
6.2.2 Online (Basic).....	29
6.2.3 Online (Refund).....	30
<b>APPENDIX A. CHANGE HISTORY (INFORMATIVE)</b> .....	<b>31</b>

## Figures

Figure 1: Charging Trigger in the Enabler Implementation .....	13
Figure 2: Charging Trigger in the Application .....	14
Figure 3: Charging Trigger in the Policy Enforcer (Intercepting).....	15
Figure 4: Charging Trigger in the Policy Enforcer (Callable).....	15
Figure 5: Triggering in the Underlying Network.....	16
Figure 6: Basic Deployment Scenario .....	17
Figure 7: Charging Agent Scenario.....	18
Figure 8: Correlation Scenario .....	21

## Tables

Table 1: Charging Trigger in the Enabler Implementation.....	13
Table 2: Charging Trigger in the application .....	14
Table 3: Charging Trigger in the Policy Enforcer.....	16
Table 4: Basic Deployment Scenario.....	18
Table 5: Charging Agent Scenario – Rating in the Charging Infrastructure.....	19
Table 6: Charging Agent Scenario – Rating in Charging Client.....	20
Table 7: Charging Agent Scenario – Rating in Charging Agent.....	20
Table 8: Correlation Scenario .....	22

# 1. Scope

This White Paper is related to the OMA Charging Enabler. It shows a number of possible ways to deploy the logical functions of the Charging Enabler with different sets of deployment entities. This White Paper should be regarded as background work for the Charging Enabler that helps the reader to understand the contents of the OMA Charging Enabler. The White Paper may also be useful for readers who are planning to implement the OMA Charging Enabler but it does not give normative deployment guidelines. These can be found from the deployment specifications of the OMA Charging Enabler.

## 2. References

### 2.1 Normative References

- [OSE] “OMA Service Environment”, Open Mobile Alliance™, OMA-Service-Environment-V1\_0, URL: <http://www.openmobilealliance.org/>
- [RFC2119] “Key words for use in RFCs to Indicate Requirement Levels”, S. Bradner, March 1997, URL: <http://www.ietf.org/rfc/rfc2119.txt>

### 2.2 Informative References

- [OMA-DICT] “Dictionary for OMA Specifications”, Open Mobile Alliance™, OMA-Dictionary, URL: <http://www.openmobilealliance.org/>
- [TS32.240] “Telecommunication management; Charging management; Charging architecture and principles”, 3GPP TS32.240 Release 6, URL: <http://www.3gpp.org>

## 3. Terminology and Conventions

### 3.1 Conventions

The key words “MUST”, “MUST NOT”, “REQUIRED”, “SHALL”, “SHALL NOT”, “SHOULD”, “SHOULD NOT”, “RECOMMENDED”, “MAY”, and “OPTIONAL” in this document are to be interpreted as described in [RFC2119].

All sections and appendixes in this document are informative.

### 3.2 Definitions

<b>Account Management</b>	Maintaining accounts, where an account is a record of debit and credit transactions. See also <i>Charging Account</i>
<b>Aggregation</b>	Combining charging information for the same session, typically over a time period.
<b>Application</b>	See [OMA-DICT]
<b>Authorization</b>	The act of determining whether something or someone will be granted access to a resource.
<b>Charging</b>	See [OMA-DICT]
<b>Charging Account</b>	See [OMA-DICT]
<b>Charging Agent</b>	An entity in the Charging Enabler that receives charging information from a Charging Enabler User and performs additional tasks/processing before sending Charging Events to an underlying Charging Infrastructure.
<b>Charging Aggregation</b>	See Aggregation.
<b>Charging Correlation</b>	See Correlation.
<b>Charging Enabler</b>	A set of functions that enable other OMA enablers, applications, or other resources to charge service users.
<b>Charging Enabler User</b>	A <i>Charging Enabler User</i> invokes and interacts with the Charging Enabler
<b>Charging Event</b>	A set of charging information sent by the Charging Enabler User for further processing.
<b>Charging Infrastructure</b>	This term denotes any infrastructure that maintains the Charging Accounts.
<b>Correlation</b>	Making a connection or relationship between Charging Events that belong to the same service, but may not be in the same session.
<b>Interface</b>	See [OMA-DICT].
<b>Offline Charging</b>	See [OMA-DICT].
<b>Online Charging</b>	See [OMA-DICT].
<b>Protocol Translation</b>	See Translation.
<b>Proxying</b>	Acting as an intermediary between a client and server, that acts as both a server and a client for the purpose of making requests on behalf of clients. The proxy passes the requests on to a client or server, with possible protocol translation, to other servers.
<b>Quota</b>	A prescribed number or share of service units generally associated with service usage. (E.g. a maximum amount of credits, time or volume for use of a service.)
<b>Quota Management</b>	Determining and allocation of a quota granted to a Charging Enabler User prior to providing a service based on the quota.
<b>Rating</b>	The function of determining the price or value of individual Charging Events.
<b>Relaying</b>	Relaying forward requests and responses to the appropriate client and server. A relay SHALL route the request or response without examining or changing non-routing information in the message.
<b>Resource</b>	Any component, enabler, function or application that can receive and process requests.
<b>Translation</b>	The act of translating from one protocol to another.

### 3.3 Abbreviations

For the purposes of this document, the abbreviations given in [OMA-DICT] apply and the following also apply:

<b>3G</b>	3 <sup>rd</sup> Generation
<b>3GPP</b>	3 <sup>rd</sup> Generation Partnership Project
<b>3GPP/2</b>	3GPP and 3GPP2
<b>3GPP2</b>	3 <sup>rd</sup> Generation Partnership Project 2
<b>CDF</b>	Charging Data Function
<b>CGF</b>	Charging Gateway Function
<b>CTF</b>	Charging Trigger Function (3GPP/2 entity)
<b>IP</b>	Internet Protocol
<b>OCS</b>	Online Charging System
<b>OMA</b>	Open Mobile Alliance
<b>OSE</b>	OMA Service Environment
<b>PoC</b>	Push-to-Talk over Cellular
<b>RD</b>	Requirements Document
<b>RFC</b>	Request for Comments
<b>URL</b>	Uniform Resource Locator
<b>WAP</b>	Wireless Application Protocol
<b>WLAN</b>	Wireless Local Area Network



## 4. Introduction

Charging is a set of functions that can be implemented in various ways that may differ considerably from each other in terms of the number and type of deployment entities used. However, these differences are mostly transparent to entities that generate Charging Events. Therefore, the OMA Charging Enabler specifications only specify the interfaces that are used to exchange information related to Charging Events, and defines the set of logical functions seen by the Charging Enabler User.

This White Paper provides more in-depth information on how the Charging Enabler may actually be deployed and can therefore help the readers of the Charging Enabler documentation to better understand the choices made and can shed more light on issues that have been specified in rather generic or abstract terms in the Charging Enabler specifications.

## 5. Deployments (Informative)

A deployment in the context of this document is a mapping of the functional components introduced in the architectural model onto a specific environment, consisting of physical entities, or network elements. This document shows possible deployments that have been specifically investigated when the Charging Enabler has been specified but other deployments are possible as well. For each deployment, a diagram and a textual description are given. The relation to the architectural model is explained by associating the functional components of the architectural model with the entities in the respective deployment scenario, which is done by means of tables.

The Charging Enabler has two distinctly different processing paths: online and offline charging (in 3GPP the online charging would correspond to the OCS and the offline to CDF and CGF). These two parts have different requirements when it comes to timing issues, capacity consumption etc. therefore the interfaces used will differ. Therefore, the deployments discussed below typically show an online charging system and an offline charging system.

The entities defined in the OSE, namely the application, the enabler implementation, and the Policy Enforcer, or other resources, are the sources of charging information in the scope of OMA. They feed either the online or offline charging. In other words, these elements can be seen to host charging triggers that invoke the Charging Enabler. All deployments below therefore show some of these OSE entities as the source of Charging Events, or in other words, a Charging Enabler User, which is a generalization of these OSE entities or other resources and can represent any of them.

Some deployments show an additional entity – the Charging Agent. The Charging Agent may perform additional processing on Charging Events as they travel from the source to the online or offline charging system.

### 5.1 Entities in the Deployments

#### 5.1.1 Charging Enabler User

Any component of the OSE or other resource that generates Charging Events related to a service usage invoking and interacting with the Charging Enabler is called a Charging Enabler User. There are three entities described in the OSE which may be Charging Enabler Users, namely, applications, enabler implementations and the Policy Enforcer. The term Charging Enabler User could be understood as a role that these entities can assume in the context of the Charging Enabler, or as an abstraction of these entities in order to handle them in a common way in the scope of the Charging Enabler.

There is a fourth potential source of Charging Events: the network elements in the underlying communication network. Charging Events originating from such an entity are likely to ultimately reach the same Charging Infrastructure as Charging Events originating from a Charging Enabler User as described above. However, they are not in the scope of the Charging Enabler specifications. Therefore the term Charging Enabler User does not cover such non-OMA network elements.

The triggering of Charging Events by any instantiation of the Charging Enabler User or by a network element of the underlying communication network is discussed in more detail in section 5.2

#### 5.1.2 Online Charging

The Online Charging denotes any Charging Infrastructure that is capable of supporting online charging. In particular, this could be an Online Charging System (OCS) as described in 3GPP [TS32.240]. However, the “Online Charging” entity could also be implemented by other charging systems, or even by a gateway into multiple other charging systems.

The online charging entity handles the online charging function, that is: a charging process where charging information can affect, in real time, the service rendered and therefore directly interacts with the session/service control.

The charging information about the usage of chargeable events is collected concurrently with the usage, which can be further processed and enriched with information from other enablers or network elements. The Charging Enabler User must in the online case first get a credit authorization from the online charging function before it can allow a user to gain access to the chargeable event.

### 5.1.3 Offline Charging

The Offline Charging denotes any Charging Infrastructure that is capable of supporting offline charging. In particular, this could be a network operator's billing domain (as described in 3GPP [TS32.240]).

The offline charging entity handles the offline charging function, that is: a charging process where charging information does not affect, in real time, the service rendered.

The charging information about the usage of chargeable events is collected concurrently with the usage, which can be further processed and enriched with information from other enablers or network elements. The offline charging function can however not influence whether a user shall be allowed to gain access to the chargeable event.

### 5.1.4 Charging Agent

A Charging Agent may, for instance, simplify charging requirements for Charging Enabler Users and promote looser coupling between Charging Enabler Users and the underlying, specific Charging Infrastructure. This is thought to be particularly useful for Charging Enabler Users that generate rather simple Charging Events that can be represented with a limited number of generic parameters (such as one-time fee, duration, volume etc) and therefore need less integration with the underlying network infrastructure than traditional communication services. A Charging Agent may also act as a control point that limits the capabilities of the underlying Charging Infrastructure that are exposed to the Charging Enabler User, and verify that the source of the charging information is authorized to perform the requested operations. This is particularly relevant in cases where the Charging Enabler User is provided by a third party external to the Charging Infrastructure provider.

## 5.2 Reference Points

### 5.2.1 R-1 - Charging Enabler User – Offline Charging

Reference point R-1 resides between a Charging Enabler User and offline charging. It is used when the Charging Enabler User knows how to determine whether to use online or offline, and has decided to use offline charging, because it is not required to affect the service delivery in real-time. The R-1 reference point needs to support at least the sending of charging data within a single message after the service delivery. Also a sequence of initial, interim and final charging data messages during and after the service delivery are preferred functionalities to be supported.

### 5.2.2 R-2 - Charging Enabler User – Online Charging

Reference point R-2 resides between a Charging Enabler User and online charging. It is used when the Charging Enabler User knows how to determine whether to use online or offline, and has decided to use online charging, in order to affect the service delivery in real-time. The R-2 reference point needs to support at least initial requesting, granting and final reporting of quota. Also interim requesting, reporting and granting of quota, price enquiry, credit check and refund are preferred functionalities to be supported.

### 5.2.3 R-3 - Charging Enabler User – Charging Agent

Reference point R-3 resides between a Charging Enabler User and a Charging Agent. It is used when the Charging Enabler User is not expected determine if it should use online or offline charging. Due to this, R-3 uses an online interface that affects the service delivery in real-time. The R-3 reference point needs to support at least initial requesting, granting and final reporting of quota. Also interim requesting, reporting and granting of quota, price enquiry, credit check and refund are preferred functionalities to be supported.

### 5.2.4 R-4 - Charging Agent – Offline Charging

Reference point R-4 resides between a Charging Agent and offline charging. It is used when the Charging Agent has determined that it should use offline charging. The R-4 reference point needs to support at least the sending of charging data within a single message after the service delivery. Also a sequence of initial, interim and final charging data messages during and after the service delivery are preferred functionalities to be supported.

## 5.2.5 R-5 - Charging Agent – Online Charging

Reference point R-5 resides between a Charging Agent and online charging. It is used when the Charging Agent has determined that it should use online charging. The R-5 reference point needs to support at least initial requesting, granting and final reporting of quota. Also interim requesting, reporting and granting of quota, price enquiry, credit check and refund are preferred functionalities to be supported.

## 5.3 Deployment-Related Functional Components

### 5.3.1 Translation

There are multiple reasons for introducing a protocol translation. The most obvious one is to simply mediate between systems that happen to understand different protocols. Another purpose of a protocol translation is protocol reduction, meaning that access to a possibly complex and powerful protocol is provided through a simpler or smaller protocol in order to make the client implementation easier, or to hide dangerous or sensitive protocol operations from un-trusted and potentially malicious clients.

### 5.3.2 Relay

In the context of the Charging Enabler, the relay function determines if a Charging Event shall be processed in an online or offline way, but will also determine where the Charging Event shall be further processed, i.e. in the own domain or in another provider's domain. The latter one would occur e.g. for roaming subscribers, where the events may need to be routed to the home network, or when the charge shall be applied to a credit card account.

In the context of the Charging Enabler, the relay function not only determines if the Charging Event shall be processed online or offline but also determines where to send the Charging Event for further processing.

The information may be embedded in the Charging Event, or the Charging Event may indicate a subscriber profile from which the information may be retrieved.

## 5.4 Triggering of Charging Events

Any service that complies with the OSE typically consists of an application that utilizes one or more enablers. It does so by talking to their respective enabler implementations through I0 interfaces. The enabler implementation in turn will typically utilize network resources in order to provide the desired functionality. Optionally, a Policy Enforcer may intercept the communication between the application and the enabler implementation in order to apply policies.

Considering this, there are four scenarios for triggering Charging Events, and any combinations of the four are allowed. The following scenarios differ by where the charging trigger resides. It can reside in an enabler implementation, an application, the Policy Enforcer and/or a network element. The case when it resides in the network element is not within scope of this document as it is handled by the specification of the network element. It is included here only for completeness and understanding of the whole area.

The further processing of the Charging Events is independent of where the triggering occurs. Therefore, the diagrams for the different triggering scenarios just show a cloud, which represents any of the Charging Enabler deployments described later on in this chapter.

The triggering scenarios described below work the same no matter if the Charging Enabler User is able to differentiate between online and offline or not. The scenarios show both a single arrow and a double arrow connected to the Charging Enabler cloud, however this is not intended to mandate that the Charging Enabler User supports the differentiation, nor that both modes need to be supported in a particular deployment.

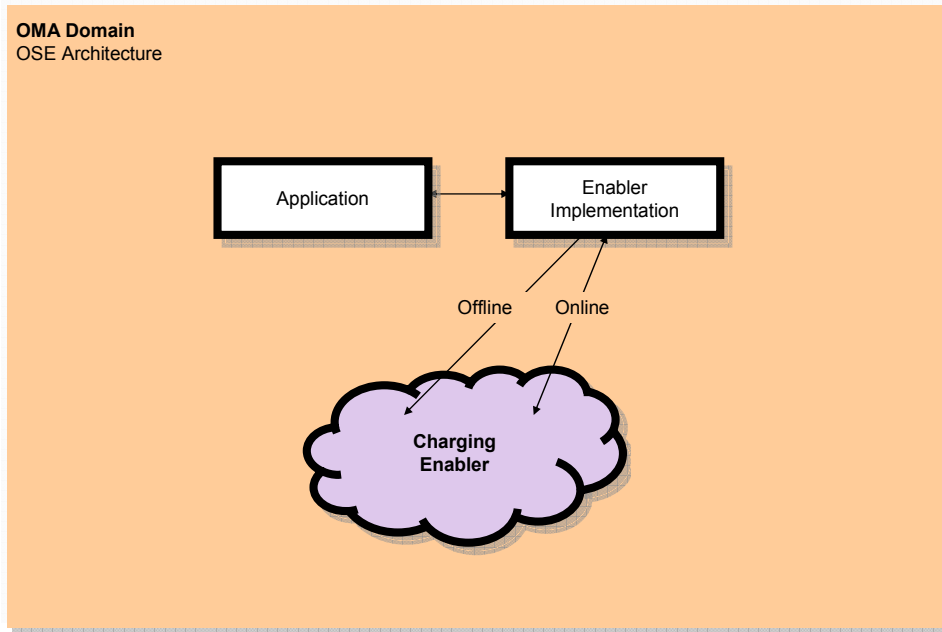

Figure 1: Charging Trigger in the Enabler Implementation

### 5.4.1 Triggering in an Enabler Implementation

In this scenario, charging triggering occurs in the enabler implementation according to the rules and requirements for the enabler. When an application accesses the enabler implementation or when the enabler implementation acts otherwise on behalf of the application, the rules and requirements for the enabler implementation will determine if and when online or offline charging shall be triggered. The scenario is illustrated in Figure 1.

	Charging Trigger	Translation	Relay	Quota Management	Rating	Authorization	Correlation/Aggregation	Account Management
Application								
Enabler Implementation	✓		✓					
Charging Enabler		✓	✓	✓	✓	✓	✓	✓

Table 1: Charging Trigger in the Enabler Implementation

In this scenario, the charging trigger is part of the enabler implementation, because the enabler implementation generates the Charging Events. The enabler implementation may also contain the Relay function if it differentiates between online and offline charging. Everything else will be provided by the Charging Enabler. The complete mapping is summarized in the Table 1.

### 5.4.2 Triggering in an Application

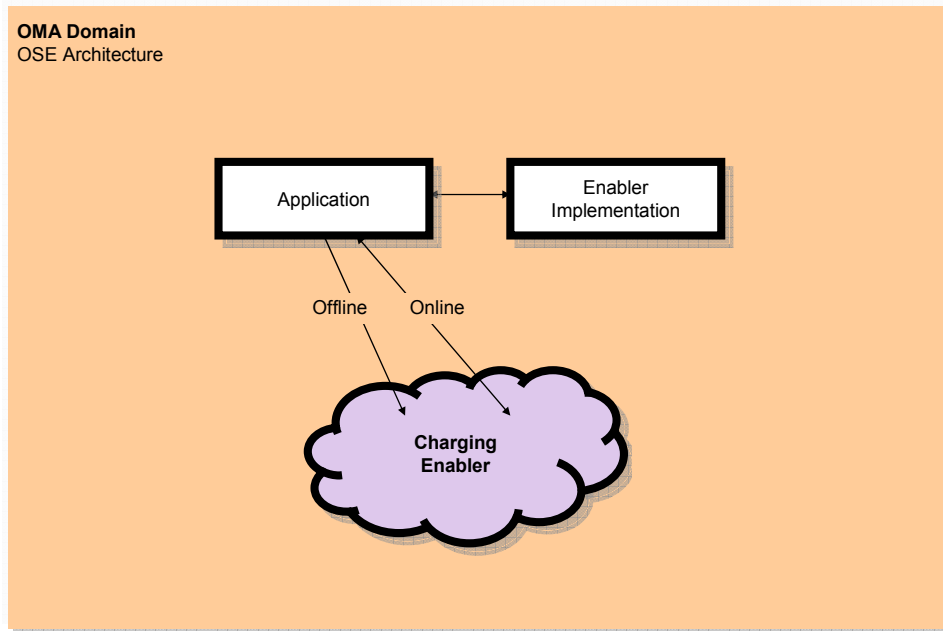

**Figure 2: Charging Trigger in the Application**

	Charging Trigger	Translation	Relay	Quota Management	Rating	Authorization	Correlation/Aggregation	Account Management
Application	✓		✓					
Enabler Implementation								
Charging Enabler		✓	✓	✓	✓	✓	✓	✓

**Table 2: Charging Trigger in the application**

In this scenario, charging triggering occurs in an application. When the application decides to access an enabler implementation or gets otherwise active in order to provide service, the rules and requirements for the application will be used to determine if and when online or offline charging shall be triggered. The scenario is shown in Figure 2.

The application contains the charging trigger. The application may also contain the Relay function in order to differentiate between online and offline charging. All other functional components are located within the Charging Enabler. The complete mapping of the functional components to the deployment entities is summarized in Table 2.

### 5.4.3 Triggering in the Policy Enforcer

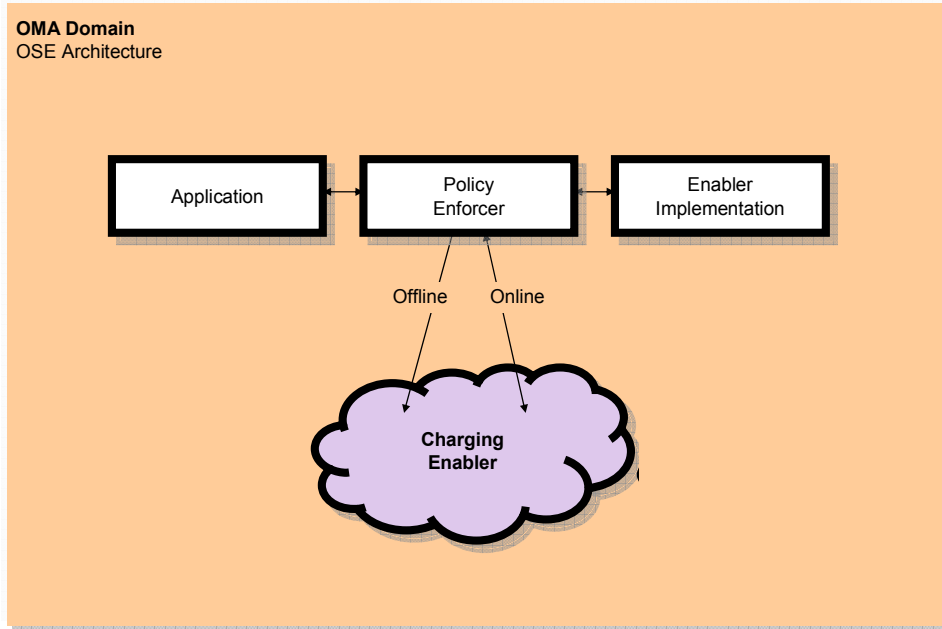

Figure 3: Charging Trigger in the Policy Enforcer (Intercepting)

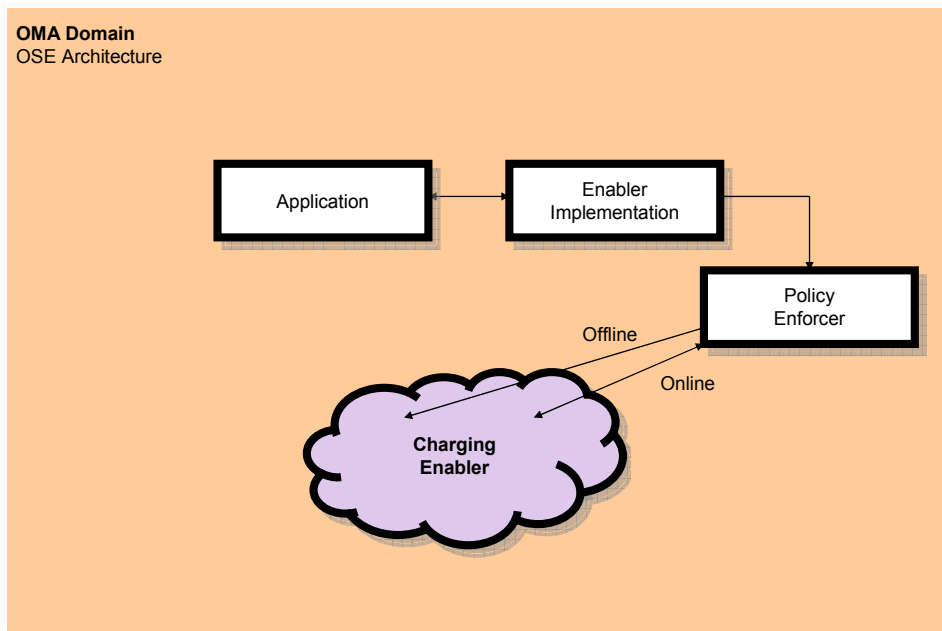

Figure 4: Charging Trigger in the Policy Enforcer (Callable)

In this scenario the Policy Enforcer is aware of how an application utilizes an enabler implementation. In order to monitor the application’s activity, the Policy Enforcer either intercepts the communication between the two (Figure 3), or is callable by the enabler implementation (Figure 4).

	Charging Trigger	Translation	Relay	Quota Management	Rating	Authorization	Correlation/Aggregation	Account Management
Application								
Policy Enforcer	✓		✓					
Enabler Implementation								
Charging Enabler		✓	✓	✓	✓	✓	✓	✓

**Table 3: Charging Trigger in the Policy Enforcer**

In both cases, the Policy Enforcer contains a charging trigger, which triggers according to the configured rules and sends appropriate Charging Events. The Relay function may be implemented by the Policy Enforcer or may be part of the Charging Enabler. Any other function, if present, will be in the Charging Enabler. The mapping is summarized in Table 3.

### 5.4.4 Triggering in the Underlying Network

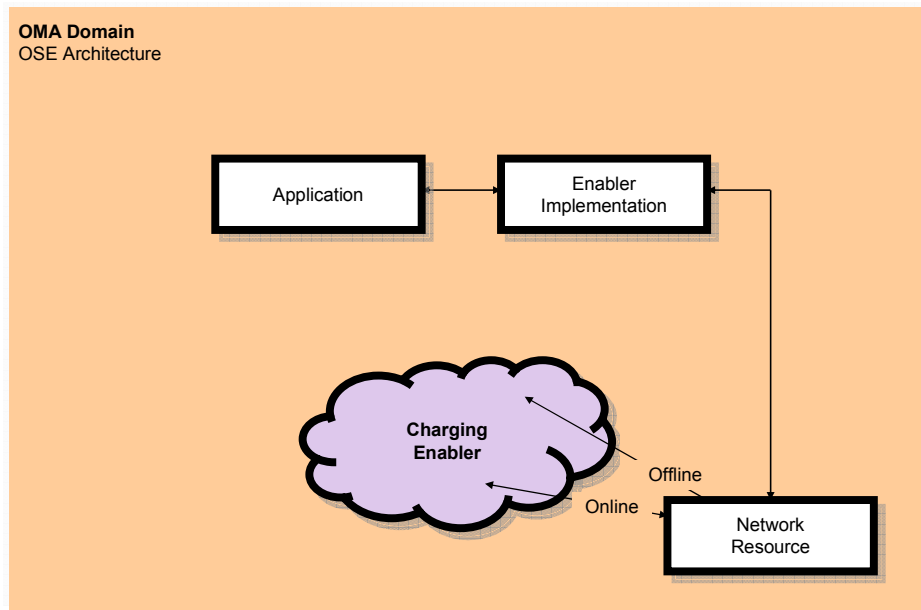

**Figure 5: Triggering in the Underlying Network**

This scenario is outside the scope of the Charging Enabler specification and given here only for illustration. It is depicted in Figure 5. Here, an application is using an enabler implementation, which in turn relies on a network element of an underlying communication network. Within the network, charging occurs, which may imply that the network resource generates Charging Events. The format of such events as well as the protocols to transmit them, are typically specified by the organization that specifies the network resource itself, e.g. 3GPP/2.

The Charging Events generated by the network resource may end up in the same domain as the Charging Events generated by OMA entities (e.g. often the Account Management function will be shared) and may even be correlated with OMA Charging Events. For that reason, the two arrows labeled “online” and “offline” point into the Charging Enabler cloud. Nevertheless,



how the network resource generates formats and transmits Charging Events is not dealt with by OMA and is not part of the Charging Enabler. Therefore, no mapping table for associating the functional components of the Charging Enabler with the entities in the scenario is given here.

## 5.5 Basic Scenario

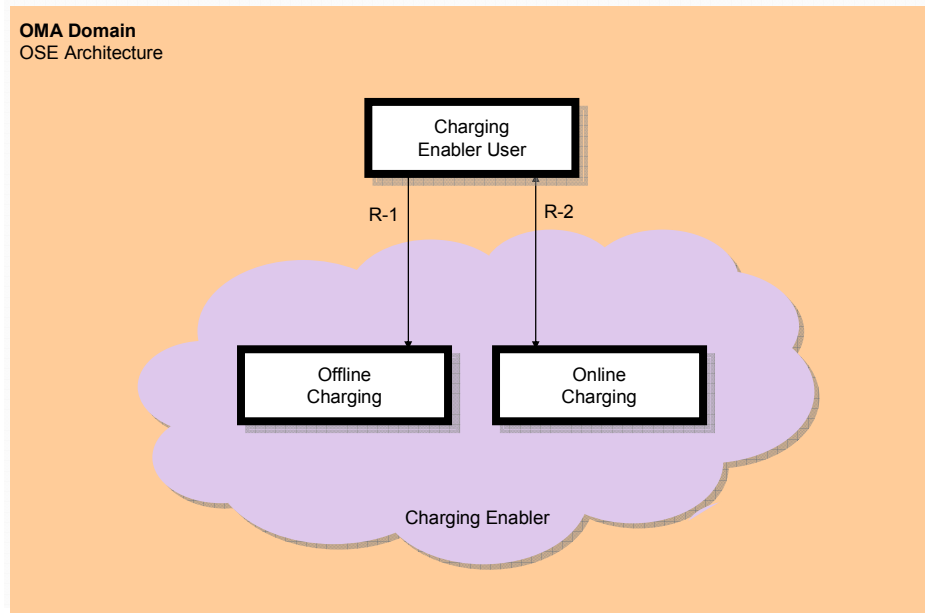

**Figure 6: Basic Deployment Scenario**

In the most basic scenario, a Charging Enabler User (i.e., an OMA application server, the Policy Enforcer, or some other resource) connects directly to an offline and/or an offline charging system, without any intermediaries, and communicates its activities. Such a scenario is illustrated in Figure 6.

The Charging Enabler User is not involved in rating its activities, but rather sends “raw” events describing its activities. However, the Charging Enabler User does distinguish between online and offline charging and is capable of selecting the right target system accordingly.

The charging trigger is by definition located in the Charging Enabler User. In addition, the Charging Enabler User hosts the Relaying function in order to route the events generated by the charging trigger to the online or offline charging system. The Quota Management function is located within the online charging but not applicable for the offline path. All other functions are either not present in this scenario (e.g. Translation) or provided by both online and offline charging.

A possible instantiation of this scenario is one where an enabler or service wishes to directly utilize charging capabilities of an underlying mobile network.

	Charging Trigger	Translation	Relay	Quota Management	Rating	Authorization	Correlation/Aggregation	Account Management
Charging Client	✓		✓					
Offline Charging					✓	✓	✓	✓
Online Charging				✓	✓	✓	✓	✓

**Table 4: Basic Deployment Scenario**

The mapping is summarized Table 4.

## 5.6 Charging Agent Scenario

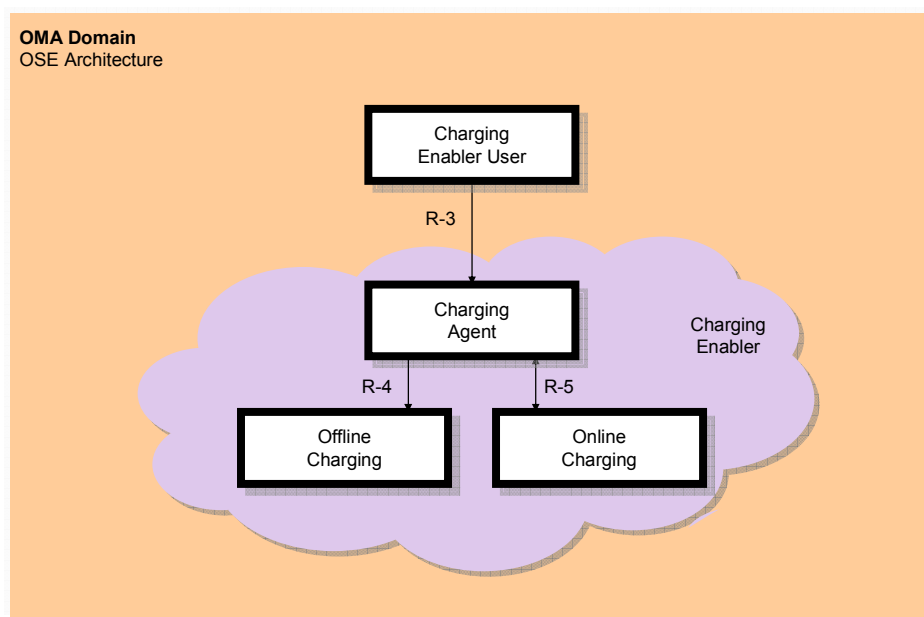

**Figure 7: Charging Agent Scenario**

In this deployment scenario, an entity called a Charging Agent resides between the Charging Enabler User and the actual Charging Infrastructure (online or offline). The Charging Enabler User sends charging information to the Charging Agent that performs additional processing before sending Charging Events to another functional components of the Charging Enabler.

In one concrete instantiation of this scenario, the Charging Agent connects an untrusted Charging Enabler User (e.g. run by a 3<sup>rd</sup> party service provider) to an operator’s Charging Infrastructure. As in all other scenarios, the Charging Enabler User implements a charging trigger, through which the Charging Enabler User talks directly to the Charging Agent. The responsibility of the Charging Agent in this scenario is

- To expose an interface towards a Charging Enabler User that is in a different domain than the underlying Charging Infrastructure. The interface towards the Charging Enabler User would typically provide reduced complexity, but

also to hide certain potentially dangerous functionality of the Charging Infrastructure from the Charging Enabler User. The Charging Agent implements the Translation function in order to fulfill this task,

- To pass on the Charging Events received from the Charging Agent to either online or offline charging, possibly after interrogating appropriate profile information related to the charged subscriber. This is equivalent to the Relay function.
- To simulate a Charging Enabler User towards both online and offline charging; this corresponds to the concept of Proxying.

The responsibility of both online and offline charging in this instantiation would then be to rate the Charging Events received from the Charging Agent and record the rated Charging Events on an account. These tasks are performed by the Rating function and the Account Management function, respectively. Additionally, the online charging would implement the Quota Management function. Correlation and Aggregation are not considered in this scenario.

	Charging Trigger	Translation	Relay	Quota Management	Rating	Authorization	Correlation/Aggregation	Account Management
Charging Client	✓							
Charging Agent		✓	✓			✓		
Offline Charging					✓	✓	✓	✓
Online Charging				✓	✓	✓	✓	✓

**Table 5: Charging Agent Scenario – Rating in the Charging Infrastructure**

The functional mapping is summarised in Table 5.

Another possible instantiation of this scenario is one where the Charging Enabler User itself is capable of determining the price of the event/service delivered (e.g. a 3<sup>rd</sup> party content merchant). In this case, the Charging Enabler User sends pre-rated events to the Charging Agent, which forwards them to the Charging Infrastructure. However, also in this case, it is likely that the Charging Infrastructure needs to finalize the rating process. This may mean, for example, currency conversion or tax handling. The configuration is summarized in Table 6.

	Charging Trigger	Translation	Relay	Quota Management	Rating	Authorization	Correlation/Aggregation	Account Management
Charging Client	✓				✓			
Charging Agent		✓	✓			✓		
Offline Charging						✓	✓	✓
Online Charging				✓		✓	✓	✓

**Table 6: Charging Agent Scenario – Rating in Charging Client**

A third possible instantiation of this scenario is where the Charging Agent hosts a rating function that is responsible for determining the price of the Charging Event before it is sent to an underlying Charging Infrastructure. This is thought to be relevant in a case where the Charging Enabler User itself does not perform rating but the Charging Agent provides a relaying service to several different Charging Infrastructures and some of the infrastructures can only accept rated events (e.g. a credit card network). Table 7 summarizes this configuration.

	Charging Trigger	Translation	Relay	Quota Management	Rating	Authorization	Correlation/Aggregation	Account Management
Charging Client	✓							
Charging Agent		✓	✓		✓	✓		
Offline Charging						✓	✓	✓
Online Charging				✓		✓	✓	✓

**Table 7: Charging Agent Scenario – Rating in Charging Agent**

## 5.7 Charging Agent Scenario with Parallel Charging enabler users

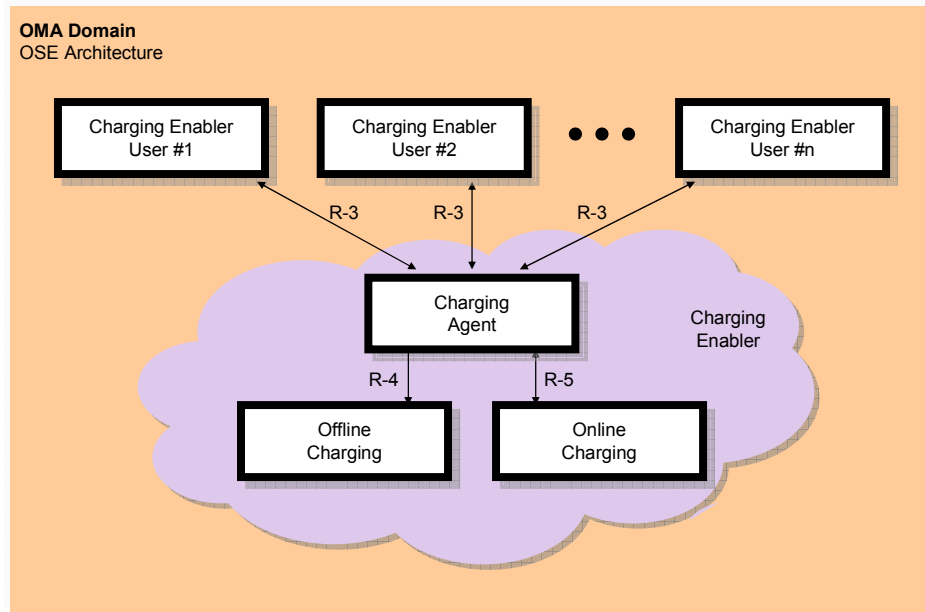

Figure 8: Correlation Scenario

In this scenario, a service is implemented by multiple entities (i.e. applications, enabler implementations, policy enforcer), each of them generating specific charging information concerning its activity. In other words, each of the entities acts as a Charging Enabler User. As far as the Charging Enabler is concerned, such scenario means that multiple Charging Enabler Users (denoted as Charging Enabler User #1 to Charging Enabler User #n) are communicating with a single Charging Agent. The Charging Agent hosts at least the Correlation/Aggregation function (to correlate the Charging Events received from different sources) and the Relay function (to forward the correlated charging information to the right target system for further processing and recording).

	Charging Trigger	Translation	Relay	Quota Management	Rating	Authorization	Correlation/Aggregation	Account Management
Charging Enabler User #1	✓							
Charging Enabler User #2	✓							
Charging Enabler User #n	✓							
Charging Agent		✓	✓	✓	✓	✓	✓	
Offline Charging					✓	✓	✓	✓
Online Charging				✓	✓	✓	✓	✓

**Table 8: Correlation Scenario**

The detailed mapping of the functional components onto the deployment entities is summarized in Table 8.

## 6. Flows

This chapter introduces message flows to illustrate how the entities in the Charging Enabler collaborate.

The following conventions are used in the flows description:

- An **asterisk** “\*” after a message indicates that the message may occur not at all, once, or multiple times in the respective flow.
- **Dashed arrows** “-----▶” indicate messages that are not mandatory. See also the explicit note about the “Profile Request/Profile Response” messages below.
- All messages that belong to reference points (i.e., R-1 ... R-5) are **prefixed** with the reference point name, e.g. “R-1:Send Charging Data”. This prefix allows using similar names for similar messages on different reference points, but still having a means to distinguish them as well.
- **Horizontal boxes**, spreading horizontally across multiple entities, indicate an interaction between these entities which is not further specified. They are given here to show the temporal dependencies between activities specified by the Charging Enabler and other activities that are not specified as part of the Charging Enabler (typically activities belonging to the service that triggers the charging). The horizontal boxes indicate abstract tasks such as “Service Request”, or “Service Interaction”, “Service Termination”. Since the Charging Enabler is designed to support many (virtually all) possible enablers and applications, the flows cannot be more specific than that.
- **Profile Request/Profile Response:** It is assumed that for some entities belonging to the Charging Enabler there is frequently the need to consult the charged user’s profile, e.g. in order to differentiate between online and offline charging. The Profile Request/Profile Response interaction illustrates that. However, this interaction is not necessarily an interaction with an external system. Profile information could e.g. be stored locally in the entity that needs to consult the profile, or sufficient information could be contained in an incoming request.
- **User Agent vs. Service user:** The flows show a user agent far to the left, but sometimes talk about service users. The relation between the two is that the service user is the individual that is authenticated and also being charged, while the user agent is the technical equipment employed by that individual to actually access and use the service. It is typically a piece of software such as a WAP browser or a SIP client, installed on a device such as a mobile handset.

## 6.1 Basic Scenario

### 6.1.1 Offline (Basic)

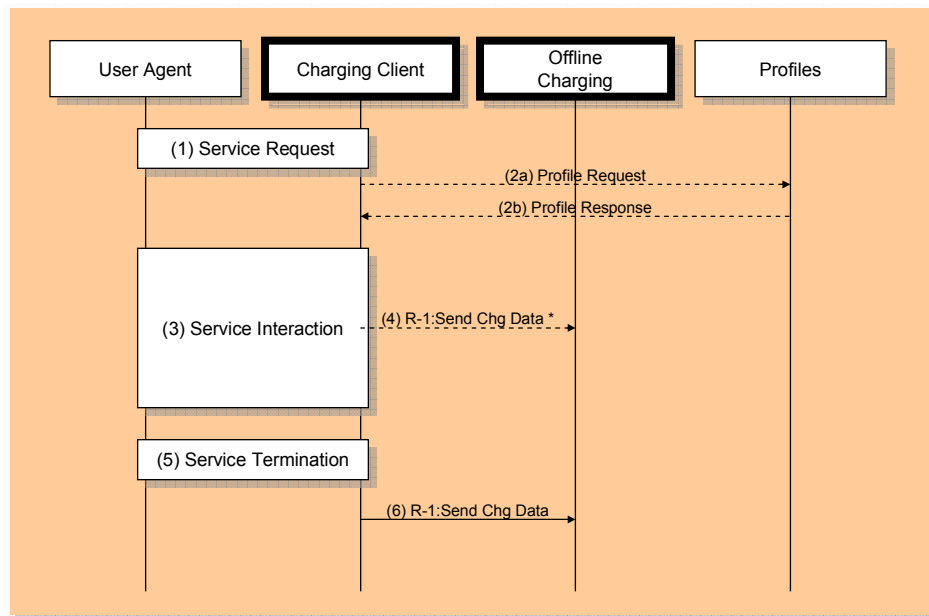

**Flow 1: Basic Scenario/Offline/Basic**

This is a possible flow for the Basic Scenario (section 5.5) for a subscriber who uses offline charging. Here, each message sent by the Charging Enabler User towards offline charging is self contained, meaning that it contains enough information for the offline charging to record a charge. Multiple such messages may occur during a service interaction, but the offline charging does not aggregate them.

1. “**Service Request**”: the subscriber invokes a service that is provided by the Charging Enabler User.
2. “**Profile Request/Profile Response**” (optional): The Charging Enabler User fetches user related profile information, e.g. in order to determine if the user has subscribed to online or offline charging. It may do so by interrogating a profile server, or accessing a locally stored profile, or may use information conveyed in the service request. In this case, the Charging Enabler User determines that the user has subscribed to offline charging.
3. “**Service Interaction**”: The service user is using the service.
4. “**R-1:Send Charging Data \***”: As a result of the service usage, the Charging Enabler User sends charging information to the offline charging system. This message may occur zero or more times.
5. “**Service Termination**”: The service user stops using the service.
6. “**R-1:Send Charging Data**”: The Charging Enabler User sends final charging information.



## 6.1.2 Offline (Advanced)

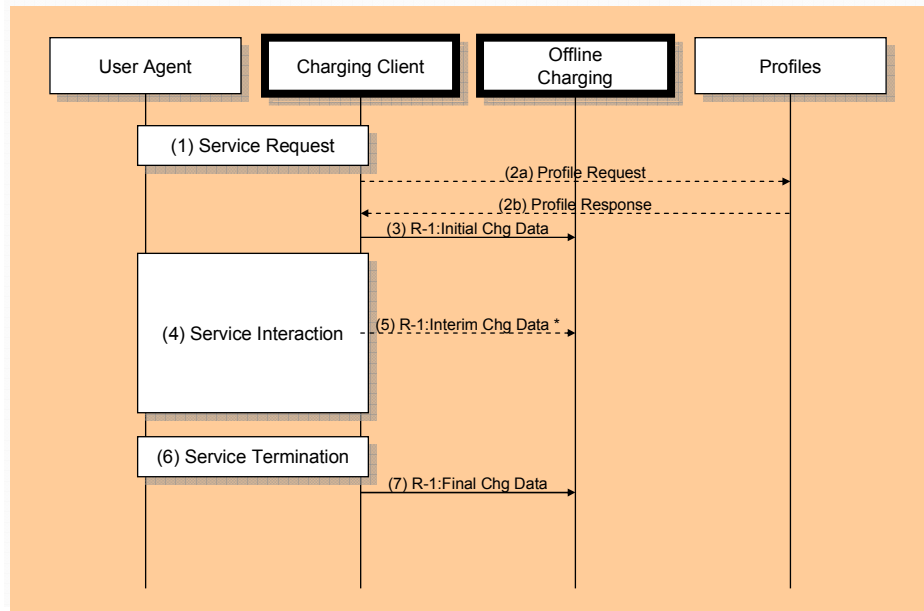

**Flow 2: Basic Scenario/Offline/Advanced**

This is a possible flow for the Basic Scenario (section 5.5) for a subscriber who uses offline charging. Contrary to the previous flow (6.1.1), here the Charging Enabler User may send a sequence of partial information which is then aggregated by the offline charging system into a final charge.

1. “**Service Request**”: the subscriber invokes a service that is provided by the Charging Enabler User.
2. “**Profile Request/Profile Response**” (optional): The Charging Enabler User fetches user related profile information, e.g. in order to determine if the user has subscribed to online or offline charging. It may do so by interrogating a profile server, or accessing a locally stored profile, or may use information conveyed in the service request. In this case, the Charging Enabler User determines that the user has subscribed to offline charging.
3. “**R-1:Initial Charging Data**”: The Charging Enabler User opens a logical session that is associated with the service interaction that is about to start. The initial charging data message could e.g. convey information describing the service and identifying the service user.
4. “**Service Interaction**”: The service user is using the service.
5. “**R-1:Interim Charging Data \***”: As the service usage proceeds, the Charging Enabler User may send at any time the charging information it has collected so far. The offline charging records this information along with the information received in the initial charging data and in previous interim charging data messages. This message may occur zero or more times.
6. “**Service Termination**”: The service user stops using the service.
7. “**R-1:Final Charging Data**”: The Charging Enabler User sends final charging information. This message implies that the session opened by the Initial Charging Data shall be closed.

### 6.1.3 Online (Basic)

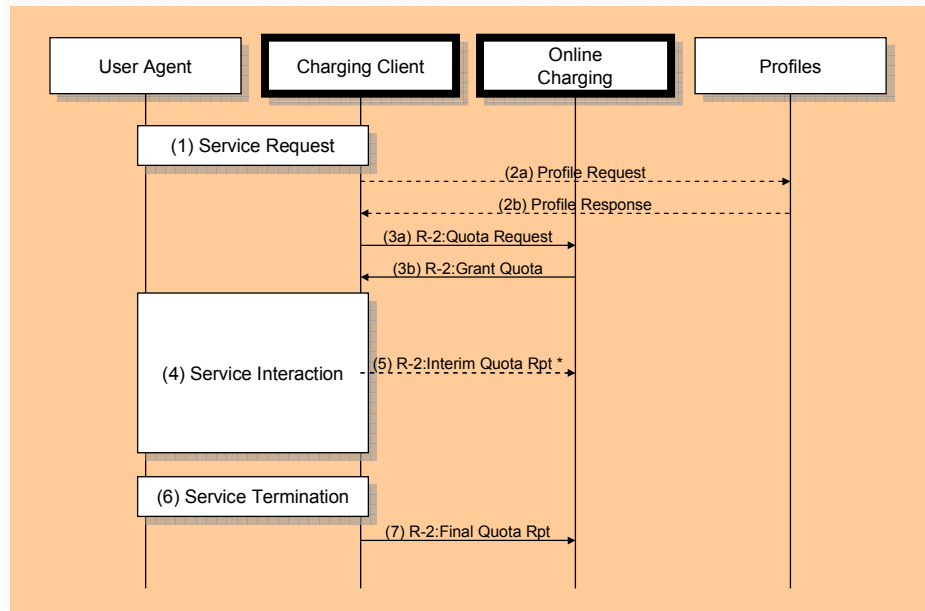

**Flow 3: Basic Scenario/Online/Basic**

This is a possible flow for the Basic Scenario (section 5.5) for a subscriber who uses online charging.

1. “**Service Request**”: the subscriber invokes a service that is provided by the Charging Enabler User.
2. “**Profile Request/Profile Response**” (optional): The Charging Enabler User fetches user related profile information, e.g. in order to determine if the user has subscribed to online or offline charging. It may do so by interrogating a profile server, or accessing a locally stored profile, or may use information conveyed in the service request. In this case, the Charging Enabler User determines that the user has subscribed to online charging.
3. “**R-2:Quota Request/R-2:Grant Quota**”: The Charging Enabler User requests the online charging to grant quota. By granting that quota, the online charging confirms that the service user has sufficient credit to cover the amount of service usage specified by the quota. The quota will be consumed during service interaction.
4. “**Service Interaction**”: The service user is using the service.
5. “**R-2:Interim Quota Report\***”: As a result of the service usage, the Charging Enabler User sends a report to the online charging, indicating the amount of quota consumed so far. The Quota Report may be combined with a quota request asking for additional quota. This message may occur zero or more times.
6. “**Service Termination**”: The service user stops using the service.
7. “**R-2:Final Quota Report**”: The Charging Enabler User sends final information about how much of the granted quota had been consumed during the service interaction.

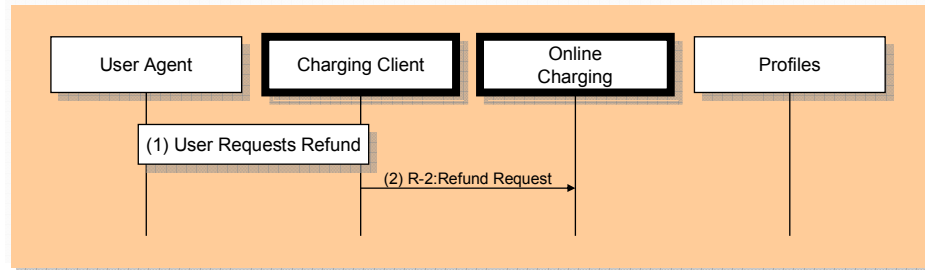
**Flow 4: Basic Scenario/Online/Refund**

### 6.1.4 Online (Refund)

This flow shows a refund of charges that a user has incurred in a previous service interaction. Such a refund could occur e.g. after a dispute has been accepted by the Charging Enabler User.

1. **“User Requests Refund”**: A user requests a refund of a previously incurred charge.
2. **“R-2:Refund Request”**: If the Charging Enabler User accepts the request for refund, it sends a Refund Request message to the online charging.
3. **“R-2:Refund Response”**: The result of the “Refund Request” is relayed back to the Charging Enabler User.

## 6.2 Agent Scenario

### 6.2.1 Offline

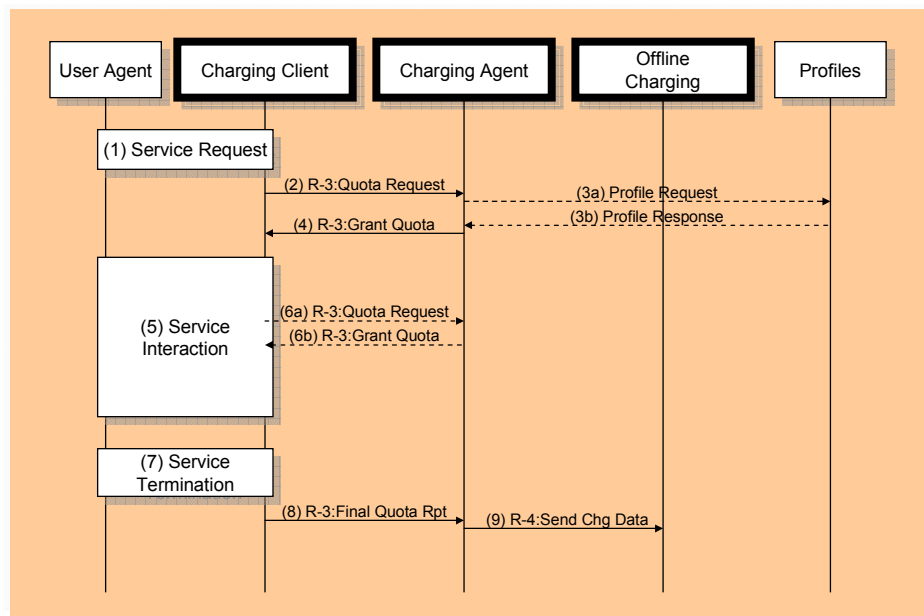

**Flow 5: Charging Agent Scenario/Offline**

This is a possible flow for the Charging Agent Scenario (section 5.6) for a subscriber who uses offline charging.

1. “**Service Request**”: the subscriber invokes a service that is provided by the Charging Enabler User.
2. “**R-3:Quota Request**”: The Charging Enabler User requests the Charging Agent to grant quota.
3. “**Profile Request/Profile Response**” (optional): The Charging Agent fetches user related profile information (see previous) and determines that offline charging is to be used for that subscriber.
4. “**R-3:Grant Quota**”: By granting that quota, the Charging Agent confirms that Charging Enabler User should allow starting the service interaction with the user. The quota will be consumed during service interaction.
5. “**Service Interaction**”: The service user is using the service.
6. “**R-3:Quota Request/R-3:Grant Quota**”: During the service interaction, the Charging Enabler User may run out of quota. Therefore it requests new quota to be granted.

Similarly, intermediate “Quota Report” messages could be sent to the Charging Agent during the service interaction (see previous flows).

Either interaction may occur zero or more times.

7. “**Service Termination**”: The service user stops using the service.
8. “**R-3:Final Quota Report**”: The Charging Enabler User sends final information about how much of the granted quota had been consumed during the service interaction.
9. “**R-4:Send Charging Data**”: The Charging Agent sends final charging information.

## 6.2.2 Online (Basic)

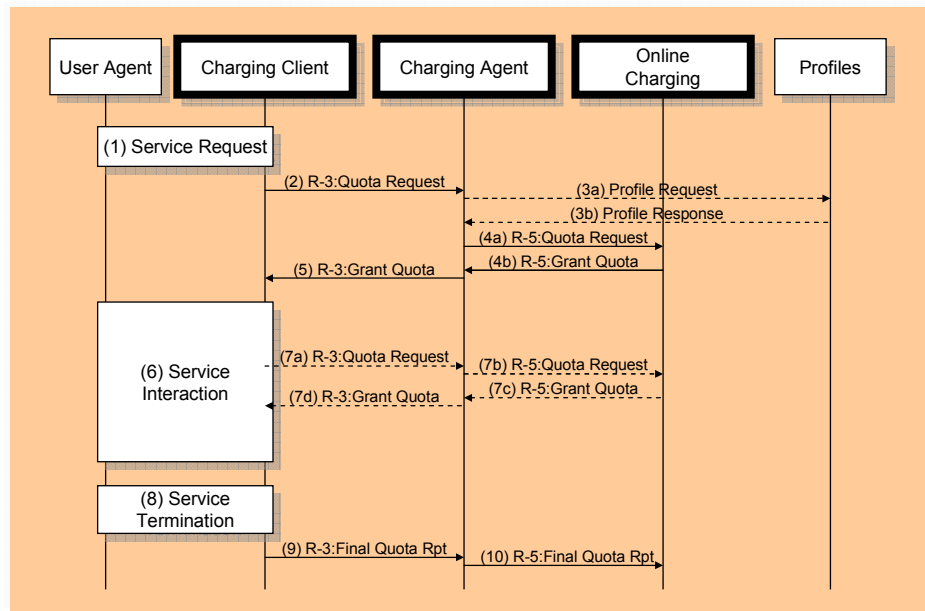

**Flow 6: Charging Agent Scenario/Online/Basic**

This is a possible flow for the Charging Agent Scenario (section 5.6) for a subscriber who uses online charging.

1. **“Service Request”**: the subscriber invokes a service that is provided by the Charging Enabler User.
2. **“R-3:Quota Request”**: The Charging Enabler User requests the Charging Agent to grant quota.
3. **“Profile Request/Profile Response”** (optional): The Charging Agent fetches user related profile information (see previous) and determines that online charging is to be used for that subscriber.
4. **“R-5:Quota Request/R-5:Grant Quota”**: The Charging Agent requests the Online Charging to grant quota, and the Online Charging honors the request.
5. **“R-3:Grant Quota”**: Since the Online Charging has granted quota to the Charging Agent, the Charging Agent in turn grants quota to the Charging Enabler User.
6. **“Service Interaction”**: The service user is using the service.
7. **“R-3:Quota Request/R-5:Quota Request/R-5:Grant Quota/R-3:Grant Quota”**: During the service interaction, the Charging Enabler User may run out of quota. Therefore it requests the Charging Agent to grant new quota. The Charging Agent in turn may interrogate the online charging with a corresponding quota request, or it may still have quota kept locally.

Similarly, intermediate “R-3:Quota Report” and “R-5:Quota Report” messages could be sent to the Charging Agent and online charging system respectively, during the service interaction (see previous flows).

Either interaction may occur zero or more times.

8. **“Service Termination”**: The service user stops using the service.
9. **“R-3:Final Quota Report”**: The Charging Enabler User sends final information about how much of the granted quota had been consumed during the service interaction.
10. **“R-5:Final Quota Report”**: The Charging Agent sends a corresponding final quota report to the online charging.

### 6.2.3 Online (Refund)

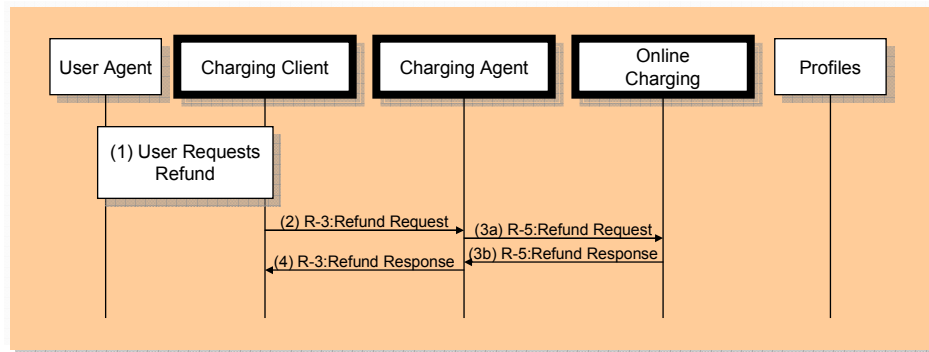

**Flow 7: Charging Agent Scenario/Online/Refund**

This flow shows a refund of charges that a user has incurred in a previous service interaction. Such a refund could occur e.g. after a dispute has been accepted by the Charging Enabler User.

1. **“User Requests Refund”**: A user requests a refund of a previously incurred charge.
2. **“R-3:Refund Request”**: If the Charging Enabler User accepts the request for refund, it sends a Refund Request message to the Charging Agent.
3. **“R-5:Refund Request/R-5:Refund Response”**: The Charging Agent sends a corresponding “Refund Request” message to the online charging, which in turn sends a “Refund Resppons” back to the Charging Agent.
4. **“R-3:Refund Response”**: The result of the “Refund Request” is relayed back to the Charging Enabler User.

## Appendix A. Change History

(Informative)

Document Identifier	Date	Sections	Description
Draft Versions OMA-WP- Charging_Deployment_Scenarios	23 Aug 2005	all	Initial version. Previously agreed material from OMA-AD-Charging-V1_0-20050503 moved unabridged to this document.
	06 Dec 2005	all	Changes made in order to be aligned with the current version of the AD document. Some definitions changed and other ones added. Term “charging client” replaced by the term “charging enabler user”. Drawings changed accordingly. Authorization function deleted in the tables. Several small misprints corrected. Based on input contribution OMA-MCC-2005-0271, which was agreed with additions (see next row).
	13 Dec 2005	all	Changes incorporated from OMA-MCC-2005-0271R01. In addition, several minor wording changes made, pictures updated. and “O-CTF” replaced with “Charging Trigger” based on input contribution OMA-MCC-2005-0288. This revision was not uploaded to MCC permanent documents but can be found from OMA-MCC-2005-288.
	05 Jan 2006	1 and 4	Scope and Introduction sections added from OMA-MCC-2005-0295.
	09 Mar 2006	all	Editorial corrections incorporated as presented in: OMA-MCC-2006-0023R01, and OMA-MCC-2006-0031.
	25 Aug 2006	all	Updated in line with consistency review comment WP-001 (see OMA-CONRR-Charging-V1_0-20060608-D).
	Candidate Version OMA-WP- Charging_Deployment_Scenarios	26 Sep 2006	n/a
Approved Version OMA-WP- Charging_Deployment_Scenarios	04 Sep 2007	n/a	Approved by OMA TP TP ref #: OMA-TP-2007-0303- INP_Charging_V1_0_ERP_for_final_approval