



Simplified Converged Address Book Architecture

Candidate Version 1.0 – 04 Sep 2012

Open Mobile Alliance
OMA-AD-S_CAB-V1_0-20120904-C

Use of this document is subject to all of the terms and conditions of the Use Agreement located at <http://www.openmobilealliance.org/UseAgreement.html>.

Unless this document is clearly designated as an approved specification, this document is a work in process, is not an approved Open Mobile Alliance™ specification, and is subject to revision or removal without notice.

You may use this document or any part of the document for internal or educational purposes only, provided you do not modify, edit or take out of context the information in this document in any manner. Information contained in this document may be used, at your sole risk, for any purposes. You may not use this document in any other manner without the prior written permission of the Open Mobile Alliance. The Open Mobile Alliance authorizes you to copy this document, provided that you retain all copyright and other proprietary notices contained in the original materials on any copies of the materials and that you comply strictly with these terms. This copyright permission does not constitute an endorsement of the products or services. The Open Mobile Alliance assumes no responsibility for errors or omissions in this document.

Each Open Mobile Alliance member has agreed to use reasonable endeavors to inform the Open Mobile Alliance in a timely manner of Essential IPR as it becomes aware that the Essential IPR is related to the prepared or published specification. However, the members do not have an obligation to conduct IPR searches. The declared Essential IPR is publicly available to members and non-members of the Open Mobile Alliance and may be found on the “OMA IPR Declarations” list at <http://www.openmobilealliance.org/ipr.html>. The Open Mobile Alliance has not conducted an independent IPR reglobal view of this document and the information contained herein, and makes no representations or warranties regarding third party IPR, including without limitation patents, copyrights or trade secret rights. This document may contain inventions for which you must obtain licenses from third parties before making, using or selling the inventions. Defined terms above are set forth in the schedule to the Open Mobile Alliance Application Form.

NO REPRESENTATIONS OR WARRANTIES (WHETHER EXPRESS OR IMPLIED) ARE MADE BY THE OPEN MOBILE ALLIANCE OR ANY OPEN MOBILE ALLIANCE MEMBER OR ITS AFFILIATES REGARDING ANY OF THE IPR'S REPRESENTED ON THE “OMA IPR DECLARATIONS” LIST, INCLUDING, BUT NOT LIMITED TO THE ACCURACY, COMPLETENESS, VALIDITY OR RELEVANCE OF THE INFORMATION OR WHETHER OR NOT SUCH RIGHTS ARE ESSENTIAL OR NON-ESSENTIAL.

THE OPEN MOBILE ALLIANCE IS NOT LIABLE FOR AND HEREBY DISCLAIMS ANY DIRECT, INDIRECT, PUNITIVE, SPECIAL, INCIDENTAL, CONSEQUENTIAL, OR EXEMPLARY DAMAGES ARISING OUT OF OR IN CONNECTION WITH THE USE OF DOCUMENTS AND THE INFORMATION CONTAINED IN THE DOCUMENTS.

© 2012 Open Mobile Alliance Ltd. All Rights Reserved.

Used with the permission of the Open Mobile Alliance Ltd. under the terms set forth above

Contents

1. SCOPE (INFORMATIVE)	6
2. REFERENCES	7
2.1 NORMATIVE REFERENCES	7
2.2 INFORMATIVE REFERENCES	7
3. TERMINOLOGY AND CONVENTIONS	8
3.1 CONVENTIONS	8
3.2 DEFINITIONS	8
3.3 ABBREVIATIONS	9
4. INTRODUCTION (INFORMATIVE)	10
4.1 VERSION 1.0	10
5. ARCHITECTURAL MODEL	12
5.1 DEPENDENCIES	12
5.2 ARCHITECTURAL DIAGRAM	12
5.3 FUNCTIONAL COMPONENTS AND INTERFACES/REFERENCE POINTS DEFINITION	13
5.3.1 Functional Components	13
5.3.1.1 S-CAB Client	13
5.3.1.2 S-CAB Server	14
5.3.1.2.1 Contact Subscription Function	14
5.3.1.2.2 Interworking Function	14
5.3.1.2.3 Contact Share Function	15
5.3.1.2.4 Contact Status Function	15
5.3.1.2.5 XDM Agent Function	15
5.3.1.2.6 XDMS Function	15
5.3.1.2.7 Presence Source Function	16
5.3.1.2.8 Presence Watcher Function	16
5.3.1.2.9 Composition Function	16
5.3.1.2.10 Indirect Update Object Function	16
5.3.1.2.11 Contact Suggestion Function	17
5.3.1.3 S-CAB XDMS	17
5.3.1.3.1 S-CAB User Preferences Application Usage	17
5.3.1.3.2 S-PCC and S-AB Application Usages	17
5.3.1.3.3 Communication History Application Usage	18
5.3.2 Interfaces/definition	19
5.3.2.1 Interface SIC-1: SIP/IP Core	19
5.3.2.2 Interface SIC-2: SIP/IP Core	19
5.3.2.3 Interface XDM-3i: Aggregation Proxy	19
5.3.2.4 Interface XDM-4i: S-CAB XDMS	20
5.3.2.5 Interface XDM-5i: Aggregation Proxy	20
5.3.2.6 Interface XDM-8.2i: Aggregation Proxy	20
5.3.2.7 Interface Push-CAI: Push Enabler	21
5.3.2.8 Interface XDM-4i: S-CAB server	21
5.3.2.9 Interface XDM-7i: S-CAB server	21
5.3.2.10 Interface S-CAB-NNII: S-CAB server	21
5.4 SECURITY CONSIDERATIONS	21
APPENDIX A. CHANGE HISTORY (INFORMATIVE)	22
A.1 APPROVED VERSION HISTORY	22
A.2 DRAFT/CANDIDATE VERSION 1.0 HISTORY	22
APPENDIX B. STAGE 2 FLOWS (INFORMATIVE)	24
B.1 CONTACT SUBSCRIPTION AND UPDATE FLOWS	24
B.1.1 FLOW 1: CREATION SCENARIO FOR NEW CONTACT'S CONTACT CARD IN S-AB APPLICATION USAGE AND ADDITION OF CONTACT TO S-CAB USER PREFERENCES SUBSCRIPTION LIST	25
B.1.2 FLOW 2: CONTACT SUBSCRIPTION CREATION FOR NEW CONTACT	25
B.1.3 FLOW 3: CONTACT SUBSCRIPTION UPDATE	27
B.1.4 FLOW 4: CONTACT SUBSCRIPTION WITH AUTOMATIC UPDATE	29

B.2 XDM-BASED DATA SYNC FLOWS.....31

B.2.1 FLOW 1: S-AB DATA SYNC SCENARIO FOR S-AB DOCUMENT CHANGE. NOTIFICATION HAS DOCUMENT CHANGES.31

B.2.2 FLOW 2: S-AB DATA SYNC SCENARIO WHEN S-CAB UE OUT OF RADIO COVERAGE, CATCH-UP, AND SUBSCRIPTION RESTART.....32

B.3 S-PCC AUTHORIZATION FLOWS.....34

B.3.1 FLOW 1: REACTIVE AUTHORIZATION FOR ACCESS TO S-CAB USER'S S-PCC34

B.3.2 FLOW 2: AUTOMATIC AUTHORIZATION FOR ACCESS TO S-CAB USER'S S-PCC36

B.4 CONTACT SHARE SCENARIO FLOWS37

B.4.1 FLOW 1: S-CAB USER CONTACT SHARE TO ANOTHER S-CAB USER37

B.4.2 FLOW 2: S-CAB USER CONTACT SHARE TO A NON-(S-)CAB USER37

B.4.3 FLOW 3: CAB USER CONTACT SHARE TO AN S-CAB USER38

B.5 IMPORT, EXPORT, SUBSCRIPTION FROM/TO NON-CAB SYSTEM SCENARIOS FLOWS39

B.5.1 FLOW 1: S-CAB USER IMPORTS CONTACT INFORMATION FROM NON-CAB SYSTEM INTO S-AB APPLICATION USAGE 39

B.5.2 FLOW 2: S-CAB USER IMPORTS TO PROFILE INFORMATION FROM NON-CAB SYSTEM INTO S-PCC APPLICATION USAGE.....41

B.5.3 FLOW 3: S-CAB USER EXPORTS ITS OWN CONTACT INFORMATION TO A NON-CAB SYSTEM.....43

B.6 EXTERNAL SEARCH FLOWS44

B.6.1 FLOW 1: CONTACT SEARCH – EXTERNAL DIRECTORIES44

B.7 S-CAB CAPABILITY FLOWS45

B.7.1 FLOW 1: S-CAB SERVER PUBLISHES S-CAB CAPABILITY AS PERMANENT PRESENCE STATE.....45

B.7.2 FLOW 2: S-CAB SERVER PUBLISHES S-CAB CAPABILITY AS A REGULAR SIP PUBLISH45

B.7.3 FLOW 3: S-CAB SERVER SUBSCRIBES TO S-CAB CAPABILITY OF ITS USER’S CONTACTS46

B.8 MANUAL APPROVAL OF CONFIRMED CONTACT CARD CHANGES48

B.9 CONTACT SUBSCRIPTION INVITATION51

B.10 S-CAB USER COMMUNICATION HISTORY HANDLING.....52

APPENDIX C. S-CAB ARCHITECTURE SHOWING XDM COMPONENTS (INFORMATIVE).....53

Figures

Figure 1: Simplified CAB Architecture Diagram12

Figure 2: Creation scenario for new contact in S-AB document25

Figure 3: Contact subscription creation26

Figure 4: Contact Subscription update manual approved.....28

Figure 5: Contact Subscription with automatic update30

Figure 6: S-AB Data Sync scenario31

Figure 7: Data Sync scenario with catch-up.....32

Figure 8: Reactive authorization35

Figure 9: Automatic authorization.....36

Figure 10: S-CAB User Contact Share to a Non-(S-)CAB User.....37

Figure 11: CAB User Contact Share to an S-CAB User.....38

Figure 12: S-CAB User imports contact information from Non-CAB System into S-AB Application Usage40

Figure 12: S-CAB User imports profile information from Non-CAB System into S-PCC Application Usage.....42

Figure 13 S-CAB User exports contact information to external profile in Non-CAB System43

Figure 14 Contact Search – External Directories	44
Figure 15: S-CAB Server publishes S-CAB capability	45
Figure 16: S-CAB Server subscribes to “CAB Capability”	46
Figure 17: S-CAB Server subscribes to “CAB Capability”	46
Figure 18: Manual Approval of Changes to Confirmed Contact Card Data	49
Figure 19: S-CAB User Contact Invitation to another S-CAB User	51
Figure 20: S-CAB User Communication History handling.....	52
Figure 21: S-CAB Architecture Showing XDM Components (Informative).....	53
Figure 22: S-CAB Architecture Diagram depicting S-CAB Capability population based on the Presence Enabler (informative).....	54

1. Scope

(Informative)

2. References

2.1 Normative References

- [S-CAB RD] “Simplified Converged Address Book Requirements”, Version 1.0, Open Mobile Alliance™, OMA-RD-S-CAB-V1_0, URL:<http://www.openmobilealliance.org/>
- [OMA DM SO] “OMA Device Management Standardized Objects”, Version 1.2, Open Mobile Alliance™, OMA-TS-DM-StdObj-V1_2, URL: <http://www.openmobilealliance.org/>
- [OMA DM TND] “OMA Device Management Tree and Description”, Version 1.2, Open Mobile Alliance™, OMA-TS-DM-TND-V1_2, URL: <http://www.openmobilealliance.org/>
- [OMA XDM AD] “XML Document Management Architecture”, Version 2.1, Open Mobile Alliance™, OMA-AD-XDM-V2_1, URL:<http://www.openmobilealliance.org/>
- [OMA XDM Core] “XML Document Management Specification”, Version 2.2, Open Mobile Alliance™, OMA-TS-XDM_Core-V2_2, URL:<http://www.openmobilealliance.org/>
- [OMA XDM RD] “XML Document Management Requirements”, Version 2.2, Open Mobile Alliance™, OMA-RD-XDM-V2_2, URL: <http://www.openmobilealliance.org/>
- [OMA Push AD] “Push Architecture” Version 2.2, Open Mobile Alliance™, OMA-AD-Push-V2_2, URL: <http://www.openmobilealliance.org/>
- [RFC2119] “Key words for use in RFCs to Indicate Requirement Levels”, S. Bradner, March 1997, URL:<http://www.ietf.org/rfc/rfc2119.txt>
- [RFC5874] IETF RFC 5874 "An Extensible Markup Language (XML) Document Format for Indicating a Change in XML Configuration Access Protocol (XCAP) Resources", J. Rosenberg, J. Urpalainen, May 2010, URL: <http://www.ietf.org/rfc/rfc5874.txt>

2.2 Informative References

- [OMA DICT] “Dictionary for OMA Specifications”, Version 2.7, Open Mobile Alliance™, OMA-ORG-Dictionary-V2_7, URL:<http://www.openmobilealliance.org/>
- [OMA DM SEC] “OMA Device Management Security”, Version 1.2, Open Mobile Alliance™, URL:<http://www.openmobilealliance.org/>
- [OMA Pres] “OMA Presence SIMPLE”, Version 2.0, Open Mobile Alliance™, URL:<http://www.openmobilealliance.org/>
- [RFC5261] IETF RFC 5261 " An Extensible Markup Language (XML) Patch Operations Framework Utilizing XML Path Language (XPath) Selectors", J. Urpalainen, September 2008, URL: <http://www.ietf.org/rfc/rfc5261.txt>
- [RFC5875] IETF RFC 5875 "An Extensible Markup Language (XML) Configuration Access Protocol (XCAP) Diff Event Package", J. Urpalainen, D. Willis, May 2010, URL: <http://www.ietf.org/rfc/rfc5875.txt>
- [CAB 1.0 AD] “Converged Address Book Architecture Description”, Version 1.0, Open Mobile Alliance™, OMA-AD-CAB-V1_0, URL:<http://www.openmobilealliance.org/>

3. Terminology and Conventions

3.1 Conventions

The key words “MUST”, “MUST NOT”, “REQUIRED”, “SHALL”, “SHALL NOT”, “SHOULD”, “SHOULD NOT”, “RECOMMENDED”, “MAY”, and “OPTIONAL” in this document are to be interpreted as described in [RFC2119].

All sections and appendixes are informative, unless they are explicitly indicated to be normative.

All sections and appendixes, except “Scope” and “Introduction”, are normative, unless they are explicitly indicated to be informative.

3.2 Definitions

Access Permissions	See [OMA XDM RD].
Application Usage	See [OMA XDM Core].
“Catch-up”	XCAP-Diff [RFC5874] and [RFC5261] based object that indicates modifications of a previously valid XDM document relative to the one present on the XDM Server at time of the creation of the XCAP-Diff object.
Composed Communication History Document	An XDM Document containing an S-CAB User’s communication history aggregated from the S-CAB User’s different devices.
Confirmed Contact Card	Contact card the S-CAB User has approved and that the S-CAB User publishes, shares, etc, with other users. It also contains information about existing changes against the confirmed contact card that require user manual approval.
Contact Card	A Contact Card is an XDM Document containing contact information regarding persons, organizations, and/or groups of persons or organizations.
Contact Share	See [S-CAB RD].
Contact Status	A contact’s S-CAB or CAB capability.
Contact Subscription	See [S-CAB RD].
Contact View	See [S-CAB RD].
External Directories	See [S-CAB TS].
External Profile	See [S-CAB RD].
S-CAB Client	A Client (see [OMA DICT]) that is used to access S-CAB features.
S-CAB User	See [S-CAB RD].
History Information	See [OMA XDM AD]
Legacy Format	See [S-CAB RD].
Management Object	See [OMA DM TND]
Non-CAB User	A User that does not support CAB or S-CAB Enablers. Typically, the User has contact information in arbitrary, non S-CAB format.
Non-CAB System	Systems external to the S-CAB and CAB Enablers containing contact information and in arbitrary formats. Sometime also called “3 rd Party System”.
Non-S-CAB System	Systems external to the S-CAB Enabler containing contact information and in formats different than S-CAB.
Non-S-CAB User	A Non-S-CAB User residing in a system external to the S-CAB Enabler.
Principal	See [OMA DICT].
S-CAB Client	A Client (see [OMA DICT]) that is used to access S-CAB features.
S-CAB Server	A network entity that implements S-CAB features.

S-CAB User	See [S-CAB RD].
S-CAB User Preferences	See [S-CAB RD].
S-CAB User Preferences Document	An XDM Document containing S-CAB User Preferences.
Search Proxy	See [OMA XDM AD].
Search Request	See [OMA XDM AD].
Simplified Personal Contact Card	Set of Contact Cards in the user directory of the S-PCC Application Usage. An S-CAB User can have one or more confirmed S-PCC. The Contact Cards in the S-PCC Application Usage directory are either Confirmed Contact Cards or Tracking Contact Cards.
Simplified Address Book	Set of Contact Cards in the user directory of the S-AB Application Usage. The Contact Cards in the S-AB Application Usage directory are either Confirmed Contact Cards or Tracking Contact Cards.
Social Network	See [S-CAB RD].
Subscription Proxy	See [OMA XDM AD].
Tracking Communication History Document	An XDM Document used to track the communication history from an S-CAB User's device.
Tracking Contact Card	Contact Card used to track contact information contained in (S-)PCC XDM documents, contact sources in 3 rd Party Systems, etc.
XDMC	See [OMA XDM AD].
XDMS	See [OMA XDM AD].
XDM Agent	See [OMA XDM AD].
XDM Document	See [OMA XDM RD].

3.3 Abbreviations

CCH	Composed Communication History
DM	Device Management
S-PCC	Simplified Personal Contact Card
S-AB	Simplified Address Book
OMA	Open Mobile Alliance
SIP	Session Initiation Protocol
XDCP	XDM Command Protocol
XDM	XML Document Management
XDMC	XML Document Management Client
XDMS	XML Document Management Server
XML	eXtensible Markup Language

4. Introduction

(Informative)

The Simplified CAB Enabler provides the CAB User with the features described in section 4.1. Principally, the Simplified CAB architecture utilizes the XDM Enabler [OMA XDM AD] to fulfill the requirements of [S-CAB RD].

4.1 Version 1.0

S-CAB Technical Specification version 1.0 supports the following features:

- 1) S-PCC and S-AB document management – The S-CAB Enabler allows S-CAB User devices and XDM-based application entities to:
 - a. Create, delete, retrieve, and replace, all or a subset of the informational elements of the S-PCC and S-AB documents;
 - b. Catch-up document changes relative to a previous valid document version;
 - c. Control access for all or a subset of the informational elements of an S-PCC and S-AB documents;
 - d. Retrieve request and modification history to the S-PCC and S-AB documents;
 - e. Restore S-PCC and S-AB Contact Cards to a previous version; and,
 - f. Write multiple document changes via XDCP request to the S-PCC and S-AB documents relative to the current XDM document version.
- 2) Automatic update and composition of Confirmed Contact Card data based on changes to Tracking Contact Cards.
- 3) Manual approval of changes to Confirmed Contact Card data based on changes to Tracking Contact Cards.
- 4) S-PCC document subscription – The S-CAB Enabler allows S-CAB Users to request their S-CAB Server subscribe to all or a subset of another S-CAB User's S-PCC Contact Cards for purposes of document change tracking.
 - a. Subscription change updates are reflected into Tracking Contact Cards.
- 5) S-PCC and S-AB document event notifications: The S-CAB Enabler allows devices of an S-CAB User to receive notifications in the following cases:
 - a. Unauthorized access, change subscription, or search requests;
 - b. Document changes; and,
 - c. Document changes requiring user involvement.
- 6) S-PCC and S-AB document forwarding – The S-CAB Enabler provides the S-CAB User with the ability to send all or a subset of their S-PCC and S-AB document information to other users, both S-CAB and Non-S-CAB Users.
- 7) S-PCC and S-AB document searching: The S-CAB Enabler provides search mechanism that allows S-CAB Users to search for information in S-PCC Contact Cards. The information returned in search operations is based on the Access Permissions of the target S-PCC Contact Cards. The S-CAB Enabler provides search function for only the S-CAB User's own S- S-AB Contact Cards.
- 8) Non-S-CAB System document searching: The S-CAB Enabler provides search mechanism that allows S-CAB Users to search for user profile information in External Directories and 3rd Party Systems i.e. in Non-CAB Systems.
- 9) Import/Export – The S-CAB Enabler provides the ability to perform import and export operations between confirmed S-PCC and S-AB Contact Cards and information stored in Non-CAB Systems. Import and export operations can be requested to occur one time or to be periodically scheduled.
 - a. Imported data changes are reflected in Tracking Contact Cards.
 - b. Interfaces to Non-CAB Systems are outside the scope of S-CAB.
- 10) Document change subscription to S-CAB User's 3rd Party External Profile: The S-CAB Enabler can subscribe to changes in user contact information in Non-CAB Systems.
 - a. Received data changes are reflected in S-PCC Tracking Contact Cards.
 - b. Interfaces to Non-CAB Systems are outside the scope of the S-CAB Enabler.

- 11) Social Network Interworking: The S-CAB Enabler expands the social networking experience of S-CAB Users.
 - a. Enriching the existing contacts with information from external Social Networks.
 - b. Provide new contact suggestions.
 - c. Changes are reflected into Tracking Contact Cards.
 - d. Interfaces to Social Network Systems are outside the scope of S-CAB.
- 12) Communication History and Usage Information from S-CAB User's devices and association of this information with S-CAB User's Contacts.

Some S-CAB requirements are dealing with lawful interception. These capabilities are generic in nature and can be resolved in various ways in a solution implementation that do not require interoperability and hence should not be specific to S-CAB, or developed as part of S-CAB. The realization of those capabilities is left to the implementation or may become a topic of activity for a future OMA enabler.

5. Architectural Model

The S-CAB Enabler re-uses concepts of other OMA Enablers, particularly the XDM [OMA XDM AD] Enabler. The S-CAB architecture is designed to support a wide range of devices independent of the user device access technologies. The architecture is based on the requirements specified in [S-CAB RD].

5.1 Dependencies

The S-CAB Enabler depends on other OMA Enablers and external entities, including the following:

- OMA XDM [OMA XDM AD] that provides the support for the functions of the S-CAB Clients, the S-CAB Server and the S-CAB XDMS(s).
- OMA DM [OMA DM SO] that provides the support for remote provisioning and management of the Management Object containing necessary configuration parameters for the S-CAB Client.
- OMA Push [OMA Push AD] that provides support for notifications to S-CAB XDM Document changes.
- SIP/IP Core [OMA XDM AD] section 5.3.2.1 “SIP/IP Core”, which performs a variety of services in support of the S-CAB functions.

5.2 Architectural Diagram

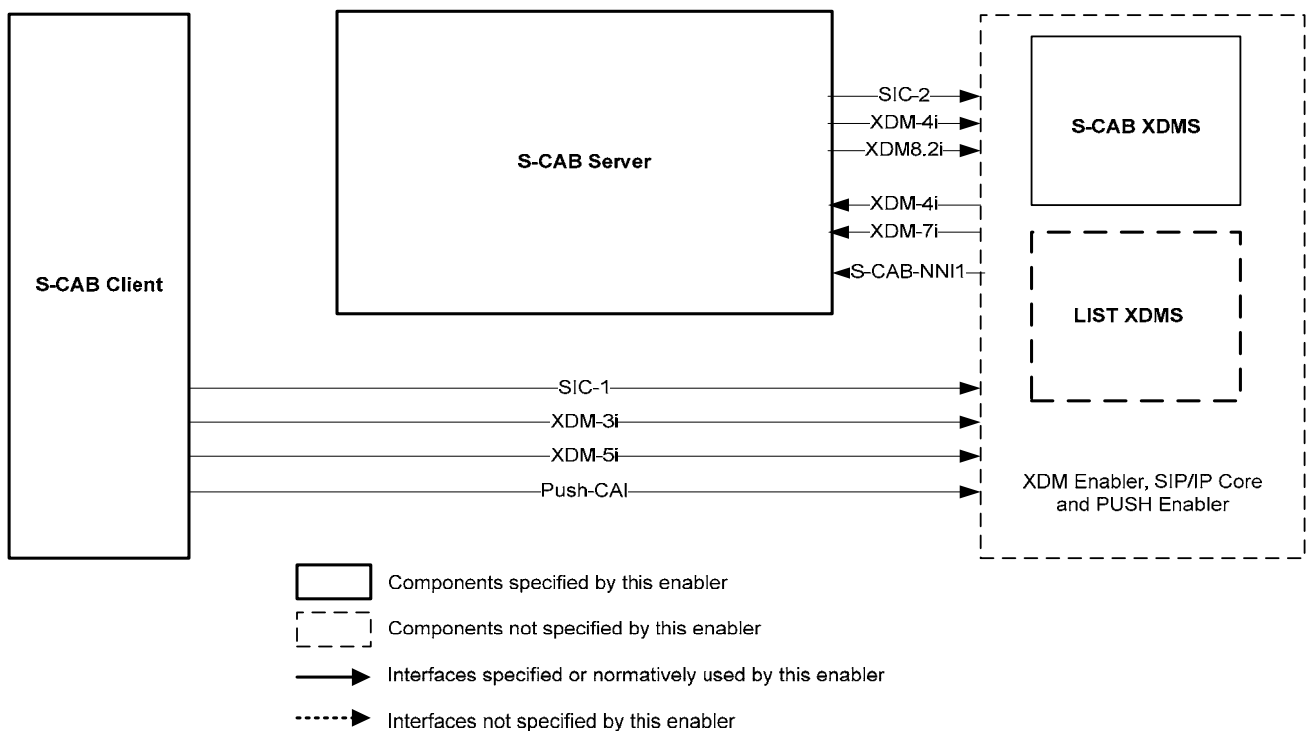

Figure 1: Simplified CAB Architecture Diagram

5.3 Functional Components and Interfaces/reference points definition

5.3.1 Functional Components

5.3.1.1 S-CAB Client

The S-CAB Client supports an XDMC as described in section 5.3.1.1 of [OMA XDM AD], and SHALL perform the following:

- Manage S-CAB XDM documents;
- Writes multiple document changes via XDCP request in standard XDM change format [RFC5874] via XDCP request to the S-PCC and S-AB documents relative to the current XDM Document version;
- Manage XDM Preferences information for the S-CAB XDM documents;
- Manage XDM History information for the S-CAB XDM documents;
- Support S-CAB XDM document change subscriptions via either SIP or non SIP mechanisms section 6.1.2 of [OMA XDM Core];
- Support subscription filters, as defined in section 6.1.2 of [OMA XDM Core];
- Receive XDM History document change notifications in standard XDM change format [RFC5874] for the S-CAB XDM documents;
- Request S-PCC and S-AB XDM document forwarding;
- Search for S-PCC and S-AB information;
- Search for 3rd Party Non-S-CAB System contact information;
- Request import on a one time basis or a periodic basis of Non-CAB System based information via XDCP requests;
- Request export on a one time basis or a periodic basis from the S-PCC and S-AB documents via XDCP requests;
- Request subscription to changes in CAB User's own profile information in Non-CAB Systems via XDCP requests;
- Request subscription to changes in S-AB contacts' information in Non-CAB Systems via XDCP requests;
- Support authentication requests and responses;
- For manual approval of changes to a Confirmed Contact Card due to changes to a Tracking Contact Card, subscribe for changes to the Update Object in the Confirmed Contact Card to determine if manual approval of a change is required for the subscribed Confirmed Contact Card, and if this is the case, read and process the referenced Indirect Update Object XDM Document;
- Update the Communication History Application Usage in S-CAB XDMS with the latest S-CAB User's Communication History and Usage Information from devices; and,

Note: the internal interaction between the S-CAB Client and other entities within the device in order to obtain the aggregated Communication History for various communications (e.g. voice, IM, CPM, SMS/MMS, etc) are out of scope of this specification.

- Retrieve the latest Communication History information from the Communication History Application Usage of the S-CAB XDMS.
- Receive suggestions for new contacts to be added to the S-CAB User's address book.
- Generate invitations for other Users to subscribe to the S-CAB User's personal information.
- Receive invitations for subscription to another S-CAB User's personal information.

The S-CAB Client sending and receiving vCard or any other Legacy Format is outside the scope of the Simplified CAB Enabler.

5.3.1.2 S-CAB Server

The S-CAB Server is a network entity that supports an XDM Agent and limited parts of an XDMS as described in sections 5.3.1.13 and 5.3.1.6 of [OMA XDM AD], respectively, and SHALL support the following functions described in the subsections below.

5.3.1.2.1 Contact Subscription Function

The S-CAB Contact Subscription Function is used to subscribe for document changes in other CAB users PCC Documents.

The S-CAB Contact Subscription Function SHALL perform the following:

- Generates subscriptions either directly or via the XDM Enabler Subscription Proxy described in section 5.3.1.3 of [OMA XDM AD] to S-CAB User S-PCC documents based on the served S-CAB User's subscription list in the served S-CAB User Preferences document;
- Supports subscription filters as defined in section 6.1.2 of [OMA XDM Core], and stored in the S-CAB User Preferences document;
- Receives document change notifications from subscribed S-PCC documents, and manages associated Tracking Contact Cards contained in the S-AB Application Usage;
- Manages Indirect Update Object XDM documents associated with tracked contact cards in case of manual approval of changes to the Confirmed Contact Cards;
- Receives catch-up document changes via XDCCP response in standard XDM change format [RFC5874] version from the S-CAB XDMS; and,
- Writes multiple document changes in standard XDM change format [RFC5874] via XDCCP request to the S-PCC and S-AB documents.

5.3.1.2.2 Interworking Function

The S-CAB Interworking Function is used to interwork with Non-S-CAB Systems.

The S-CAB Interworking Function SHALL perform the following:

- Perform format adaptation between S-PCC (S-AB) format and Non-CAB System formats;
- Imports contact information on a one-time basis or a periodic basis from Non-CAB Systems according to S-CAB User requests conveyed via XDCCP request, and stores in Tracking Contact Cards in accordance with S-PCC (S-AB) Access Permissions;
- Subscribes to change events in Non-CAB Systems according to S-CAB User requests conveyed via XDCCP, and stores in Tracking Contact Cards in accordance with S-PCC (S-AB) Access Permissions;
- Manages Indirect Update Object XDM documents associated with tracked contact cards;
- Exports contact information from S-PCC (S-AB) Confirmed Contact Cards on a one-time basis, a periodic basis, or a document change basis towards Non-CAB Systems, based on S-CAB User requests conveyed via XDCCP request from the S-CAB User, in accordance with S-PCC (S-AB) Access Permissions;
- Performs Contact Search towards Non-CAB Systems based on S-CAB User requests conveyed via the XDM-5i to the S-CAB Server;
- Receives catch-up XDM document changes via XDCCP response in standard XDM change format [RFC5874] from the S-CAB XDMS relative to the current S-PCC and S-AB document version the S-CAB Server possesses; and,
- Writes document changes via XDCCP request in standard XDM change format [RFC5874] to the S-PCC and S-AB documents relative to the current XDM Document version.

5.3.1.2.3 Contact Share Function

The S-CAB Contact Share function is used to share information in an S-CAB User's S-AB and S-PCC documents with other users.

The S-CAB Contact Share Function SHALL perform the following:

- Performs format adaptation between S-PCC (S-AB) format and Non-S-CAB System formats;
- Supports S-PCC (S-AB) XDM Document Forwarding with the CAB 1.x Enabler(s);
- Delivers S-PCC (S-AB) contact cards to external recipients in Non-S-CAB Systems based on S-CAB User requests conveyed via XDCP request from the S-CAB User, in accordance with S-PCC (S-AB) Access Permissions;
- Receives catch-up XDM document changes in standard XDM change format [RFC5874] from the S-CAB XDMS relative to the current S-PCC (S-AB) document version the S-CAB Server possesses; and,
- Writes multiple document changes in standard XDM change format [RFC5874] via XDCP request to the S-PCC (S-AB) documents relative to the current XDM Document version.

5.3.1.2.4 Contact Status Function

The Contact Status Function populates the S-CAB or CAB capability of a contact. While several mechanisms are possible to determine the S-CAB capability of other users, such as: one time Contact Subscription, contact search, exchange of S-CAB capability through Presence Server [OMA Pres], none is mandated by this specification.

If the S-CAB Server supports the exchange of S-CAB capability information via the Presence Enabler [OMA Pres], the S-CAB Server SHALL perform the following:

- Through the Presence Source Function publishes to the Presence Enabler the S-CAB capability for those S-CAB Users served by this S-CAB Server (as Permanent Presence State [OMA Pres] to the Presence XDMS, or as a regular SIP Publish to the Presence Server);
- Through the Presence Watcher Function subscribes to the Presence information of the contacts of the S-CAB Users served by this S-CAB Server in order to receive their S-CAB or CAB capability as part of the Presence information updates; and,
- Through the XDM Agent Function requests updates in the S-PCC document to include S-CAB User's contacts S-CAB capability information.

The Contact Status Function is used to notify an S-CAB User about his/her inclusion in other S-CAB Users and CAB 1.0 Users Address Books.

5.3.1.2.5 XDM Agent Function

The XDM Agent Function is a supporting entity used by other S-CAB Server functions for interaction with the XDM Enabler.

The XDM Agent Function as described in section 5.3.1.13 of [OMA XDM AD] SHALL perform the following:

- Acts as a supporting entity for interactions with S-CAB XDMS(s) via XDM-4i, XDM-8.2i, and SIC-2 interfaces.

5.3.1.2.6 XDMS Function

The XDMS function is a supporting entity used by other S-CAB Server functions for interaction with the XDM enabler.

The XDMS function SHALL perform the following:

- Receives XCAP GET requests targeting Indirect Update Object documents via its XDM-4i interface;
- Receives XDCP requests targeting the S-CAB Interworking Function via its XDM-4i interface;
- Receives XDCP requests targeting the S-CAB Contact Share Function via its XDM-4i interface; and,

- Receives Search requests targeting the S-CAB Interworking Function via its XDM-7i interface.

5.3.1.2.7 Presence Source Function

The Presence Source function is a supporting entity used by other S-CAB Server functions for interactions with the Presence Enabler [OMA Pres] and SHALL perform the following:

- Publishes the S-CAB User's CAB capability to the Presence Enabler [OMA Pres].

5.3.1.2.8 Presence Watcher Function

The Presence Watcher function is a supporting entity used by other S-CAB Server functions for interactions with the Presence Enabler [OMA Pres] and SHALL perform the following:

- Subscribes to the Presence information of S-CAB User's contacts and receives updates with the information about their S-CAB and CAB capability.

5.3.1.2.9 Composition Function

The S-CAB Composition function is used to merge information from Tracking Contact Cards into Confirmed Contact Cards, and from Tracking Communication History Documents into the Composed Communication History Document.

The S-CAB Composition Function SHALL perform the following:

- When automatic update setting is configured in the S-CAB User Preferences, the S-CAB Composition Function directly merges tracked S-PCC (S-AB) XDM Tracking Contact Cards into the Confirmed Contact Card in accordance with S-CAB User settings and Service Provider policies;
- When manual approval setting is configured in the S-CAB User Preferences, the S-CAB Composition Function dynamically generates changes to Confirmed Contact Card data in standard XDM change format [RFC5874] based on changes to the associated Tracking Contact Card, in accordance with S-CAB User settings and Service Provider policies, and returns changes to the S-CAB Client in response to an XCAP GET as an Indirect Update Object;
- Manage Update Object status in both cases, as necessary; and,
- Merge the S-CAB User's Tracking Communication History Documents into the Composed Communication History Document.

5.3.1.2.10 Indirect Update Object Function

The Indirect Update Object function is supporting entity to the Composition Function. The Indirect Update Object function contains the Indirect Update Object Application Usage.

The Indirect Update Object Application Usage SHALL include zero or one Indirect Update Object XDM document associated with one Confirmed Contact Card (i.e., S-PCC or S-AB XDM document).

The Indirect Update Object Application Usage SHALL support the following XDM functions:

- XCAP Read operation only, as described in [OMA XDM AD] sections 5.3.1.6.1 and 5.3.1.6.8; and,
- Request History as described in [OMA XDM AD] section 5.3.1.6.5.

Access Permissions to an Indirect Update Object XDM document SHALL only be given to a Principal also having Access Permissions to update the associated Confirmed Contact Card.

The Indirect Update Object function SHALL create and delete Indirect Update Object XDM documents. There SHALL be one Indirect Update Object XDM document per Tracking Contact Card. The Indirect Update function SHALL track the Update Object of a Confirmed Contact Card. When the S-CAB Client deletes an Update Object, the Indirect Update Object function SHALL delete the associated Indirect Update Object Document. The Indirect Update Object XDM document is only utilized when the S-CAB User configures manual approved update of contact card changes; it is neither utilized nor applicable when automatic updates of a contact card has been configured in the S-CAB User Preferences.

The Indirect Update function then SHALL dynamically generate the associated Indirect Update Object XDM document and return to the S-CAB Client. The generated Indirect Update Object XDM document SHALL contain changes against the Confirmed Contact Card based on changes against the associated Tracking Contact Card.

Note: The S-CAB User has the option to accept, reject, or modify changes contained in an Update Object.

5.3.1.2.11 Contact Suggestion Function

The Contact Suggestion Function is used to inform the S-CAB User about new contacts that exists and is suggested to be added the S-CAB User's address book.

5.3.1.3 S-CAB XDMS

The S-CAB XDMS are server entities as described in subclauses 5.3.1.6 and 5.3.1.12 of [OMA XDM AD]. These Application Usages are logical entities in nature.

S-CAB XDM documents requirements are presented in the following subsections.

5.3.1.3.1 S-CAB User Preferences Application Usage

The S-CAB User Preferences Application Usage represents a network repository for all S-CAB User preferences data, and SHALL support the following functions:

- Management as described in [OMA XDM AD] section 5.3.1.6.1 and 5.3.1.6.8;
- Subscription and Notification document changes, as described in [OMA XDM AD] section 5.3.1.6.2; and,
- Access Permissions as described in [OMA XDM AD] section 5.3.1.6.3.

5.3.1.3.2 S-PCC and S-AB Application Usages

The S-PCC and S-AB Application Usages represent the network repository for all contact card data. There is one contact card per XDM document and vice versa. When CAB 1.0 and 1.1 XDM Agents and Clients access the S-AB and S-PCC XDM documents, they receive CAB 1.0 compatible PCC and AB XDM documents.

The S-PCC represents contact cards the S-CAB User seeks to publish and make available to other S-CAB Users. The S-AB represents contact cards of contacts of the S-CAB User. The S-PCC and S-AB Application Usages exist as separately defined entities to allow independent Access Permissions for S-PCC and S-AB contact cards.

A "persona" SHALL be associated with one Confirmed Contact Card, however, that association MAY occur via a hidden XUI to Confirmed Contact Card: To hide an XUI when the S-CAB User seeks to disguise a persona, the S-CAB User uses XDM Document References to a confirmed document instance as described in section 5.3.1.6.6 of [OMA XDM AD].

Tracking contact cards are used to store imported, synchronized Non-CAB System contact information, Social Network, or Service Provider Enhanced, or Contact Subscription data. There SHALL be one Tracking Contact Card XDM document instance per imported, synchronized Non-CAB System, Social Network, or Service Provider Enhanced, or Contact Subscription data source; however, external tracking SHALL only apply to the S-PCC Application Usage. For one Confirmed Contact Card there can be zero or more Tracking Contact Cards. The upper limit of contact card document instances (confirmed and tracking) is based on service provider policies, which may be different for S-PCC and S-AB Application Usages.

A Confirmed Contact Card consists of two parts:

- Confirmed contact data
- Sequence of Update Objects

Confirmed contact data contains the following data types in accordance with [S-CAB XDMS]:

- Person-details
- Organization-details
- Group-details.

Tracked contact card data contains the following data types in accordance with [S-CAB XDMS]:

- Person-details
- Organization-details
- Group-details.

Update Object data is meta-information (XML attributes), which includes:

- Binding to the Tracking Contact Card expressed as an XCAP URI reference;
- XDCP command transaction identifier, if any;
- 3rd Party source identifier, if any;
- Associated XDM command type (e.g., contact share, import, social network interworking), if any;
- XCAP URI reference of the “Indirect Update Object” associated with this Update Object; and,
- Tracking contact card status, including the following types of status data:
 - Contact subscription status, if the Tracking Contact Card is updated by document change notification such as with an S-PCC XDM document or a 3rd Party system external profile; and,
 - Import timestamp.

The S-PCC and S-AB Application Usages SHALL support the following functions:

- Management as described in [OMA XDM AD] section 5.3.1.6.1 and 5.3.1.6.8;
- Subscription and Notification of document changes as described in [OMA XDM AD] section 5.3.1.6.2;
- Access Permissions as described in [OMA XDM AD] section 5.3.1.6.3
- Search as described in [OMA XDM AD] section 5.3.1.6.4 (search only applies to the S-CAB User’s own S-AB contact information);
- History and Restore as described in [OMA XDM AD] section 5.3.1.6.5;
- Forwarding as described in [OMA XDM AD] section 5.3.1.6.7;
- Document Reference as described in [OMA XDM AD] section 5.3.1.6.6; and,
- Deletion of multiple documents as described in [OMA XDM Core] section 6.1.1.3.8 “*Multiple Document Delete*”.

XDM Request History documents SHALL be utilized for reactive authorization of incoming subscriptions, as outlined in [XDM TS].

5.3.1.3.3 Communication History Application Usage

The Communication History Application Usage SHALL represent the network repository for all Communication History data from all devices of the S-CAB User.

The Application Usage SHALL support one Composed Communication History (CCH) XDM Document per S-CAB User and one Tracking Communication History (TCH) XDM Document per S-CAB User device. The information from the TCH XDM Documents is merged into the CCH XDM Document.

Once the S-CAB User decides to keep the Composed Communication History version on any of his device(s), then the Tracking Communication History Document(s) for the device(s) is removed from the S-CAB XDMS.

The Communication History Application Usages SHALL support the following functions:

- Management operations as described in [OMA XDM AD] section 5.3.1.6.1 and 5.3.1.6.8;
- Subscription and Notification of XDM Document changes as described in [OMA XDM AD] section 5.3.1.6.2; and,
- Access Permissions as described in [OMA XDM AD] section 5.3.1.6.3.

Communication History Application Usages includes the following data:

- It SHALL include the communication type;
- It SHALL include the date and timestamp of the communication;
- It MAY include the duration of the communication (if applicable to a communication type, e.g. voice calls, chat);
- It SHALL include the identity of the other user(s) involved in the communication;
- It SHALL include a binding, expressed as an XCAP URI reference, to S-AB Contacts associated with identities of the other user(s) involved in the communication, when the other users are also S-AB Contacts; and,
- It MAY include usage information associated to the other user involved in the communication. The usage information is a free form field which can contain various data (e.g. Contact ranking based on frequency of communications, favourite contacts) that is subject to service provider settings.

5.3.2 Interfaces/definition

5.3.2.1 Interface SIC-1: SIP/IP Core

The S-CAB Client SHALL use the SIC-1 interface, as defined in [OMA XDM AD] to authenticate, request subscription and receive notification of XDM document changes to S-CAB XDM documents, if the S-CAB UE supports SIP-based XDM document change mechanism.

5.3.2.2 Interface SIC-2: SIP/IP Core

The S-CAB Server SHALL use the SIC-2 interface, as defined in [OMA XDM AD], for S-CAB XDM document subscription and notifications.

5.3.2.3 Interface XDM-3i: Aggregation Proxy

The S-CAB Client SHALL use the XDM-3i interface as defined in [OMA XDM AD] to perform the following:

- XDM-3i to perform S-CAB XDM document management, subscription, notification, and restore;
- XDM-3i to perform S-PCC and S-AB document forwarding;
- XDM-3i to perform History and Access Permissions document management, subscription, and notification for S-CAB XDM documents;
- XDM-3i to request import and export of contact information with Non-CAB Systems;
- XDM-3i to subscribe to changes in CAB User's user profile at Non-CAB Systems;
- XDM-3i to subscribe to changes in contact information stored in Non-CAB Systems;
- XDM-3i to read Indirect Update Object XDM documents contained in the S-CAB Server;
- XDM-3i to receive catch-up XDM document changes for S-CAB XDM documents relative to the current XDM Document version that the S-CAB Client currently possesses;
- Authentication between XDMC and Aggregation Proxy, as required;
- Compression according to the Service Provider's local policy, as required;
- XDCCP-based subscription to XDM document changes, if the S-CAB UE supports non-SIP XDM document change mechanism;
- XDM-3i to write multiple XDM document changes via XDCCP request to the S-PCC and S-AB documents relative to the current XDM Document version;
- Import and Export requests and responses via XDCCP-based request;

- Subscription requests to CAB User's user profile updates in Non-CAB Systems via XDCP-based request; and,
- Request and receive credentials to be used with Non-S-CAB Systems via XDCP-based request.

5.3.2.4 Interface XDM-4i: S-CAB XDMS

The S-CAB Server SHALL use the XDM-4i interface as defined in [OMA XDM AD] to perform the following:

- Management of S-CAB S-PCC, S-AB, and S-CAB User Preference documents;
- Forwarding of XDM resources;
- Access permissions management;
- History function and related preferences management;
- History and Restore of S-CAB XDM documents;
- Reception of XDCP document forwarding requests from the S-PCC and S-AB Application Usages applicable for recipients in Non S-CAB Systems;
- Write multiple XDM document changes via XDCP request to the S-PCC and S-AB documents relative to the current XDM Document version; and,
- Receive catch-up document changes relative to the current XDM Document version the S-CAB Server possesses.

5.3.2.5 Interface XDM-5i: Aggregation Proxy

The S-CAB Client SHALL use the XDM-5i interface as defined in [OMA XDM AD] to perform the following:

- Search information stored in S-CAB XDM documents, including History documents;
- Search for contact related information in External Directories;
- Optional mutual authentication of search requests between S-CAB Client and Aggregation Proxy as defined in [OMA XDM AD]; and,
- Optional compression according to the Service Provider's local policy, as defined in [OMA XDM AD].

5.3.2.6 Interface XDM-8.2i: Aggregation Proxy

The S-CAB Server uses the XDM-8.2i interface as defined in [OMA XDM AD] to perform the following operations via the Aggregation Proxy:

- Management of S-CAB XDM documents ;
- Management of Access Permissions documents;
- Management of S-CAB XDM History documents and related User Preference documents;
- Restore function of S-CAB XDM documents;
- Receive catch-up XDM document changes relative to the current XDM Document version the S-CAB Server possesses;
- Write multiple XDM document changes via XDCP request to the S-PCC and S-AB documents relative to the current XDM Document version; and,
- Reception of XDCP document forwarding requests from the S-PCC and S-AB Application Usage applicable for Non-S-CAB recipients residing in Non-S-CAB Systems.

5.3.2.7 Interface Push-CAI: Push Enabler

The S-CAB Client SHALL use the Push-CAI interface, as defined in [OMA Push AD] for notification of XDM document changes to S-CAB XDM documents, if the S-CAB UE supports the non-SIP XDM document change mechanism.

5.3.2.8 Interface XDM-4i: S-CAB server

The XDM-4i interface in the S-CAB Server SHALL be used to perform the following operations:

- Order importing of information from Non-CAB System using Import XDCP requests;
- Order exporting of information to Non-CAB System using Export XDCP requests;
- Forwarding of S-CAB Documents to Non-S-CAB Systems using Forwarding XDCP requests;
- Handling of Remote Forwarding XDCP requests from Non-S-CAB Systems; and,
- Retrieval of Indirect Update Object documents using Retrieve an XDM Document XCAP requests.

5.3.2.9 Interface XDM-7i: S-CAB server

The XDM-7i interface in the S-CAB Server SHALL be used to perform the following operation:

- Search in external Non-CAB Systems using XDM Search Requests.

5.3.2.10 Interface S-CAB-NNI1: S-CAB server

The S-CAB-NNI1 interface is exposed by the S-CAB Server for the following functionality:

- To send a notification with 'S-CAB Contact Added' data, when a S-CAB User has added another S-CAB User or a CAB 1.0 User;
- To receive a notification with 'S-CAB Contact Added' data, when another S-CAB User, or a CAB 1.0 User has added the S-CAB User into their Address Book.

Note: This interface offers a sub-set of the functionality of CAB-NNI described in [CAB1.0 AD].

5.4 Security Considerations

The S-CAB Enabler provides confidentiality and integrity protection for the operations used to exchange S-PCC information. The S-CAB Enabler SHOULD support the following security aspects:

- OMA XDM security;
- OMA DM security.

The security applicable to S-CAB XDMS and XDM interfaces is specified in [OMA XDM AD] "Security Considerations".

The security applicable to the device provisioning and configuration is specified in [OMA DM SEC].

The security between the S-CAB Server and Non-CAB based systems is outside the scope.

Appendix A. Change History (Informative)

A.1 Approved Version History

Reference	Date	Description
n/a	n/a	No prior version –or- No previous version within OMA

A.2 Draft/Candidate Version 1.0 History

Document Identifier	Date	Sections	Description
Draft Versions: OMA-AD-S_CAB-V1_0	09 Feb 2011	All	On line edit starting from CR 0008R02
	22 Feb 2011	App D	Following Agreed CR is incorporated OMA-COM-CAB-AD-2011-0013-CR-contact-share-annex,
	21 Apr 2011	5.3.1.1, 5.3.1.2, 5.3.2.7, 5.3.2, 4.	Following Agreed CRs are incorporated: OMA-COM-CAB-2011-0068R01-CR_PCC_Interworking OMA-COM-CAB-2011-0071R01-CR_S_AD_section_5.3.1.1 OMA-COM-CAB-2011-0073R01-CR_S_AD_section_5.3.1.2 OMA-COM-CAB-2011-0076R01-CR_S_AD_section_5.3.2 OMA-COM-CAB-2011-0078R01-CR_S_AD_section_into
	25 Apr 2011	App B/D, B.6	Following Agreed CRs are incorporated OMA-COM-CAB-2011-0033-CR_S_CAB_AD_Appendix_Reorder OMA-COM-CAB-2011-0080R01-CR_S_AD_external_search
	20 May 2011	2.2, 5.3.1.2	Following Agreed CR is incorporated OMA-COM-CAB-2011-0067R03-CR_CAB_Capability
	07 Jun 2011	3.2, 3.3	Following agreed CRs are incorporated in the S-CAB 1.0 AD OMA-COM-CAB-2011-0128-CR_A033
	08 Jul 2011	B.7	Following agreed CR is incorporated in the S-CAB 1.0 AD OMA-COM-CAB-2011-0185R01-CR_SCAB_AD_CAB_Capability_Flows CR Against
	13 Jul 2011	5.3.2.1 5.3.2.8	Following agreed CR is incorporated in the S-CAB 1.0 AD OMA-COM-CAB-2011-0142-CR_SCAB_AD_AI_038
	18 Aug 2011	All 4.1 B.5, B.6	OMA-COM-CAB-2011-0224R02-CR-S-CAB-AD-edit Updated draft to reflect Option A e-vote outcome. Added S-AB and edited previous flows to show S-AB. Also, replaced direct interface with XDM-3i and new XDPC command. OMA-COM-CAB-2011-0232R01-CR_S_CAB_1.0_AD_Update_Section_4.1 OMA-COM-CAB-2011-0231R01-CR_S_CAB_AD_Additional_Scenarios
	31 Aug 2011	2.1, 5.3.1, App C	OMA-COM-CAB-2011-0250R01-CR_S_CAB_AD_IWF_Requirements_Edit, OMA-COM-CAB-2011-0246R01-CR_S_CAB_Capability_AD_Diagram
	14 Oct 2011	2.3, 3.2, 5.3.1.5, App B2, B4	OMA-COM-S-CAB-2011-0006R01-CR_AD_Additional_Scenarios_Part2, OMA-COM-S-CAB-2011-0008R02-CR_AD_multiple_PCC_and_references, OMA-COM-S-CAB-2011-0009R01-CR_AD_AI061, OMA-COM-S-CAB-2011-0010R01-CR_AD_reject_reactive_authorization
	01 Dec 2011	5.3.1.2, App C, B.8.3	OMA-COM-S-CAB-2011-0007R02-CR_AD_composition_function, OMA-COM-S-CAB-2011-0035R01-CR_A072_Contact_Type
	15 Feb 2012	Annex B.9	OMA-COM-S-CAB-2012-0005R01-CR_manual_change_approval_scenario
	21 Feb 2012	Sections 4.1, 5.3, and Annex B10	OMA-COM-S-CAB-2012-0023R01-CR_AI_2011_A073 OMA-COM-S-CAB-2012-0007R03-CR_AD_section_4_1 OMA-COM-S-CAB-2012-0006R03-CR_AD_section_5_3_1_update
	03 Apr 2012	Section 3.2	OMA-COM-S-CAB-2012-0038-CR_AD_ai_for_section_3.2
	16 Apr 2012	Section 4.1, 3.3, 5.1, 5.2, 5.3.1.1, 5.3.1.2, 5.3.1.3, 5.3.1.4, 5.3.2, B.2, B.10, C	OMA-COM-S-CAB-2012-0055-CR_AD_section_5.2 OMA-COM-S-CAB-2012-0053- CR_AD_Update_Object_and_conflict_resolution_via_hints OMA-COM-S-CAB-2012-0058R01-CR_AD_section_5.3.1.2_restruct OMA-COM-S-CAB-2012-0062R01-CR_AD_Section_5.3.2_Add_missing_Interface_Descriptions OMA-COM-S-CAB-2012-0059-CR_AD_Indirect_Update_object_Editor_s_Notes OMA-COM-S-CAB-2012-0057R01-CR_AD_Client_IUO_handling_clarification OMA-COM-S-CAB-2012-0043R01-CR_AD_COMM_History OMA-COM-S-CAB-2012-0061R01-CR_AD_AppC_figures_corrections OMA-COM-S-CAB-2012-0056R01-CR_AD_Section_5.3.1.1_Interface_descriptions Some editorial changes.
	17 Apr 2012		OMA-COM-S-CAB-2012-0060-CR_AD_XDM_Enabler_references_bugfixing OMA-COM-S-CAB-2012-0054R01-CR_AD_section_3.2

Document Identifier	Date	Sections	Description
	20 Jun 2012		OMA-COM-S-CAB-2012-0113-CR_AD_B12 OMA-COM-S-CAB-2012-0114-CR_AD_B11_Section_B2 OMA-COM-S-CAB-2012-0115-CR_AD_B11_Section_B3 OMA-COM-S-CAB-2012-0116-CR_AD_B13 OMA-COM-S-CAB-2012-0118-CR_AD_B22 OMA-COM-S-CAB-2012-0120R01-CR_AI_009
	03 Jul 2012		OMA-COM-S-CAB-2012-0125-CR_AD_B09_10 OMA-COM-S-CAB-2012-0126-CR_AD_B16_19_20_11 OMA-COM-S-CAB-2012-0127-CR_AD_B11_section_B7 OMA-COM-S-CAB-2012-0128-CR_AD_B3_4 OMA-COM-S-CAB-2012-0129-CR_AD_B21
	09 Jul 2012		OMA-COM-S-CAB-2012-0146R01-CR_AD_B01_02_06_07_08_15_23
	13 Jul 2012		OMA-COM-S-CAB-2012-0151R01-CR_AD_B05__A004_A005_A009_C067 Minor editorial changes (e.g. deactivating hyperlinks to URLs outside OMA, capitalizing Non-CAB System, Non-S-CAB System, Non-CAB User. Non-S-CAB User in a number of places)
	24 Jul 2012	App B.5	Incorporated CR: OMA-COM-S-CAB-2012-0158-CR_CONR_B015. Editorial removal of "Tables" heading in Content, as no tables exist in this document.
Candidate Version: OMA-AD-S_CAB-V1_0	04 Sep 2012	All	Status changed to Candidate by TP: OMA-TP-2012-0326-INP_SCAB_V1_0_ERP_for_Candidate_Approval

Appendix B. Stage 2 Flows (Informative)

In the following flow scenarios, the labelling of XDM interfaces in the figures follows the guidelines of Annex B "*How to show re-use of the XDM Enabler*" [OMA XDM AD].

B.1 Contact Subscription and Update Flows

Contact Subscription and Update Flows

Flow 1: Creation of contact's Confirmed Contact Card in the S-AB Application Usage and the addition of contact to subscription list in the S-CAB User Preferences document.

Flow 2: S-CAB Server creation of contact subscription based on addition of contact to the S-CAB User Preferences document.

Flow 3: Subscription update when User Preferences are set for non automatic update operation, which requires user approval of each subscription update.

Flow 4: Subscription update when User Preferences are set for automatic update operation, which does not require user approval of subscription updates.

Notes:

- XDM proxies are not shown.
- S-CAB Server and Client have up-to-date ETags.

B.1.1 Flow 1: Creation scenario for new contact's Contact Card in S-AB Application Usage and addition of contact to S-CAB User Preferences subscription list

Prerequisites:

- A Confirmed Contact Card for this contact does not exist in the S-CAB User's S-AB S-AB Application Usage User Directory.
- The S-CAB Server has a subscription for document changes in the S-CAB User's S-CAB User Preferences document.
- The S-CAB User inserts contact information about a new contact.

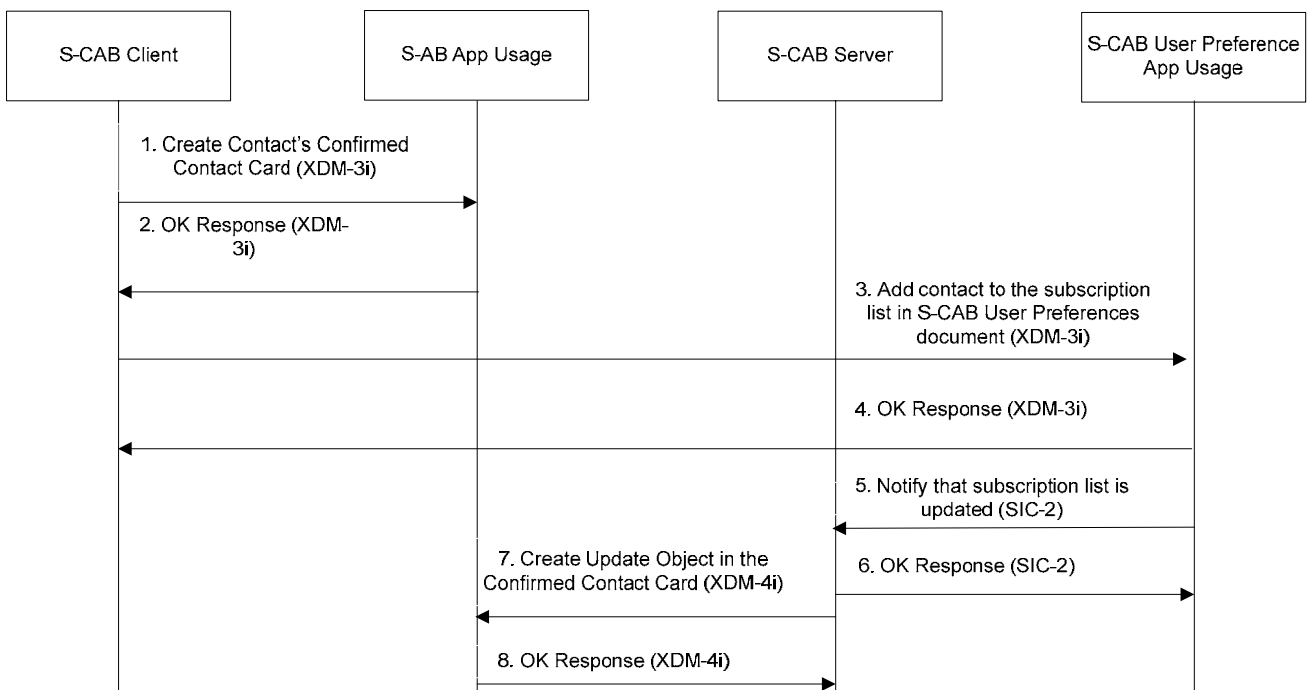

Figure 2: Creation scenario for new contact in S-AB document

- Summary:
 - Steps 1&2: The S-CAB Client successfully creates the contact's Confirmed Contact Card document in the S-CAB User's User Directory with contact information provided by the S-CAB User
 - Steps 3&4: The S-CAB Client successfully adds this contact's identity to the S-CAB User Preference document subscription list.
 - Step 5&6: The S-CAB XDMS notifies successfully the S-CAB Server about the change to the subscription list.
 - Step 7&8: the S-CAB Server updates successfully the contact's Confirmed Contact Card with information about the subscription that shall be established towards the contact's S-PCC Document (see Flow 2).

B.1.2 Flow 2: Contact subscription creation for new contact

Prerequisites:

- The contact’s Confirmed Contact Card for which subscription tracking is desired exists in S-CAB User’s S-AB Application Usage User Directory.
- There is no subscription for this contact the contact’s S-PCC Document in the S-PCC Application Usage.
- The S-CAB Server has previously subscribed to the S-CAB User’s S-CAB User Preferences document, and has an up-to-date ETag for the S-CAB User Preference document.

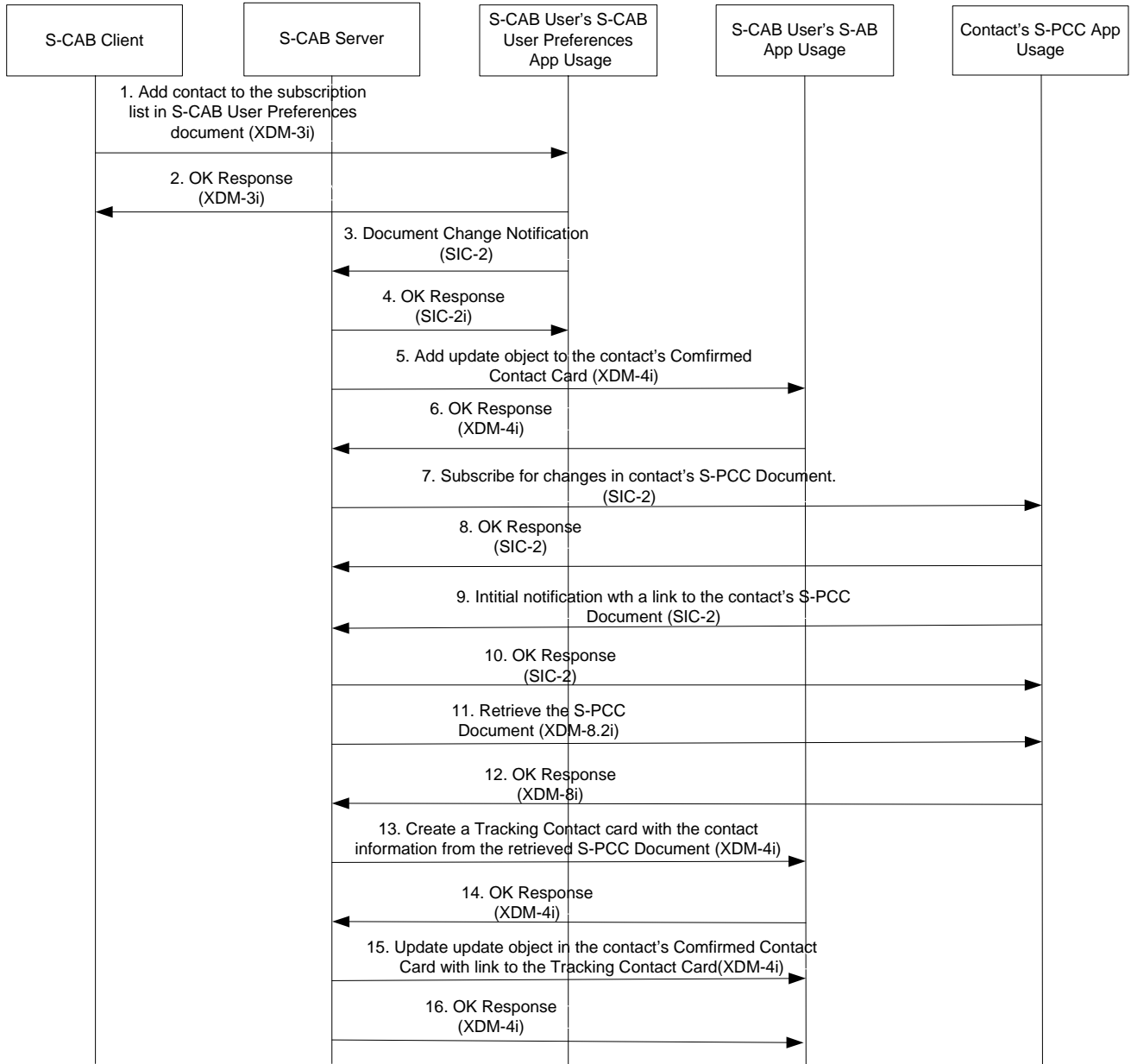

Figure 3: Contact subscription creation

- Summary:
 - Steps 1&2: The S-CAB Client successfully adds this contact to the S-CAB User Preference document subscription list.
 - Steps 3&4: The S-CAB Server successfully receives a document change notification from the S-CAB User Preferences document indicating the addition of the new contact to subscription list.

- Steps 5&6: The S-CAB Server successfully creates an update object in the Confirmed Contact Card associated with the contact in the S-CAB User's S-AB Application Usage User Directory with information about the subscription.
- Steps 7&8: The S-CAB Server successfully creates a subscription to the S-PCC document of the newly added contact.
- Steps 9&10: The S-CAB Server successfully receives version information about the contact's S-PCC Document and an XCAP URI to the document
- Steps 11&12: The S-CAB Server successfully retrieves the S-PCC Document using the XCAP URI
- Steps 13&14: The S-CAB Server successfully creates a Tracking Contact Card that is a copy of the received S-PCC Document.
- Steps 15&16: The S-CAB Server successfully updates the update object in the Confirmed Contact card with the Document Selector to the Tracking Contact card and with information about that the subscription was successfully performed.

Note: Flows 3 and 4 below shows the different types of updates i.e. manual approved update or automatic update can be result of the subscription.

B.1.3 Flow 3: Contact Subscription update

Prerequisites:

- The contact subscription has been created. The first step of this flow is either the notification from the creation of the subscription or a subsequent notification change when the S-PCC document of the subscribed contact has been updated with a change that this S-CAB User is permitted to receive. The S-CAB User Preferences is set for non automatic update, which means the S-CAB User has to approve each contact subscription update to a Confirmed Contact Card.
- The S-CAB Client has an ongoing subscription for document changes to Confirmed Contact Cards in the S-CAB User's S-AB Application Usage User Directory.
- The S-CAB Server has an ongoing subscription for document changes to Confirmed Contact Cards in the S-CAB User's S-AB Application Usage User Directory to monitor the update object associated with the contact subscription.

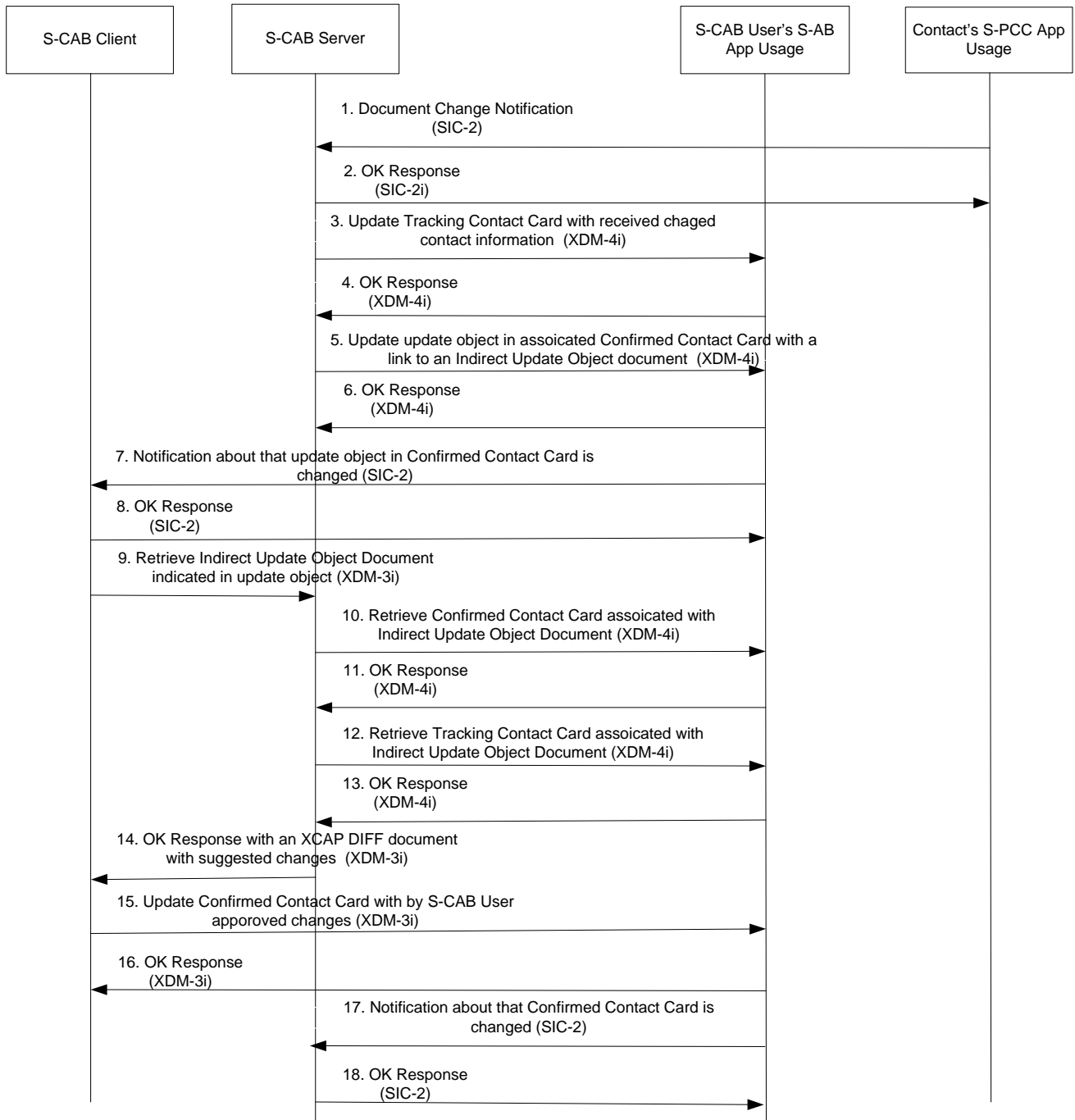

Figure 4: Contact Subscription update manual approved

- Summary:
 - Steps 1&2: Contact S-PCC Application Usage successfully sends document change notification to the S-CAB Server. The change is in XCAP-Diff format or a reference to the S-PCC Document with version information. If that is the case the S-CAB will retrieve the S-PCC Document and generate an XCAP-Diff formatted change before doing the next step.
 - Steps 3&4: The S-CAB Server successfully writes the update to the Tracking Contact Card associated with the contact subscription

- Steps 5&6: The S-CAB Server successfully updates the update object with a Document Selector to an Indirect Update Object Document.
- Steps 7&8: The S-CAB Client successfully receives a document change notification from the S-AB Application Usage subscription indicating that a new Indirect Update Object Document associated with a contact subscription exists to retrieve.
- Step 9: The S-CAB Client send a request to retrieve the Indirect Update Object Document.
- Steps 10&11: The S-CAB Server successfully retrieves the Confirmed Contact Card associated with the Indirect Update Object Document
- Steps 12&13: The S-CAB server successfully retrieves the Tracking Contact Card associated with Confirmed Contact Card
- Step 14: The S-CAB Server generates an XCAP DIFF document based on the difference between the Confirmed Contact Card and the Tracking Contact Card and sends it to the S-CAB Client.
- Steps 15&16: The S-CAB Clients presents the suggested changes to the S-CAB User. The S-CAB User selects which changes he/she wants to apply to the Confirmed Contact Card and the S-CAB client removes not selected changes and successfully sends a Differential Write request targeting the Confirmed Contact Card with the modified XCAP DIFF document.
- Steps 17&18: The S-CAB Server is successfully notified about the Confirmed Contact Card is updated.

B.1.4 Flow 4: Contact Subscription with automatic update

Prerequisites:

- The S-CAB User Preferences are set to automatic update.
- The S-CAB Client has an ongoing subscription for document changes to Confirmed Contact Cards in the S-CAB User's S-AB Application Usage User Directory.
- A Tracking Contact Card exists already for this contact subscription.

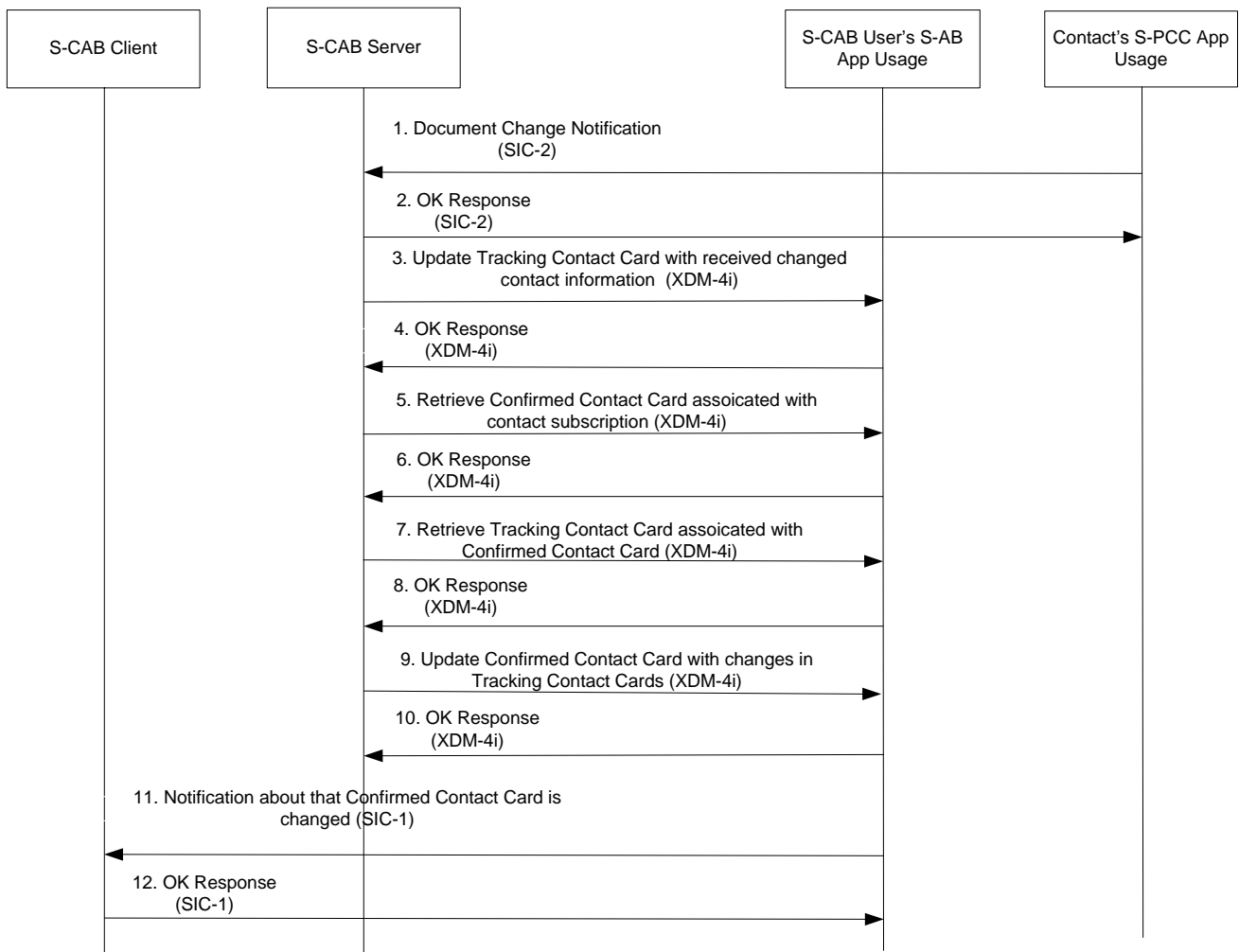

Figure 5: Contact Subscription with automatic update

Summary:

- Steps 1&2: Contact’s S-PCC Application Usage successfully sends a document change notification to the S-CAB Server. The update contains the XCAP-Diff formatted change or a reference to the S-PCC Document with version information. If that is the case the S-CAB will retrieve the S-PCC Document and generate a XCAP-Diff formatted change before doing the next step.
- Steps 3&4: The S-CAB Server successfully writes the update to the Tracking Contact Card associated with the contact subscription.
- Steps 5&6: The S-CAB Server successfully retrieves the Confirmed Contact Card associated with the contact subscription.
- Step 7&8: The S-CAB Server successfully retrieves a Tracking Contacts Card associated with the Confirmed Contact Card. Steps 7&8 are repeated if more than one update object exists associated with this Confirmed Contact Card.
- Step 9&10. The S-CAB Server successfully updates the Confirmed Contact with the changes that is the result of merging information from all Tracking Contact Cards as described in section 5.3.1.2.9.
- Steps 11&12: As a result of the previous step, the S-CAB Client receives a document change notification from the Confirmed Contact associated with the contact subscription, which by hypothesis includes the XCAP-Diff change. The S-CAB Client updates its locally stored S-AB Document copy.

B.2 XDM-based Data Sync Flows

Flow 1: S-AB Data Sync scenario when one user device updates the S-AB Document associated with a contact and the other device is within radio coverage.

Flow 2: S-AB Data Sync scenario when S-CAB Client #1 moves out of radio coverage, misses an S-AB document change notification, and then returns to radio coverage.

Notes:

- XDM proxies are not shown.
- It is assumed the S-CAB Clients have an up-to-date ETag for the S-AB documents in the S-CAB User's S-AB Application Usage User Directory.

B.2.1 Flow 1: S-AB Data Sync scenario for S-AB document change. Notification has document changes.

Prerequisites:

- The S-CAB Client #1 is assumed to have an existing S-AB subscription to the S-CAB User's S-AB document and an up-to-date ETag.
- The S-CAB User is changing contact information for a contact with an existing S-AB document using S-CAB Client #2.

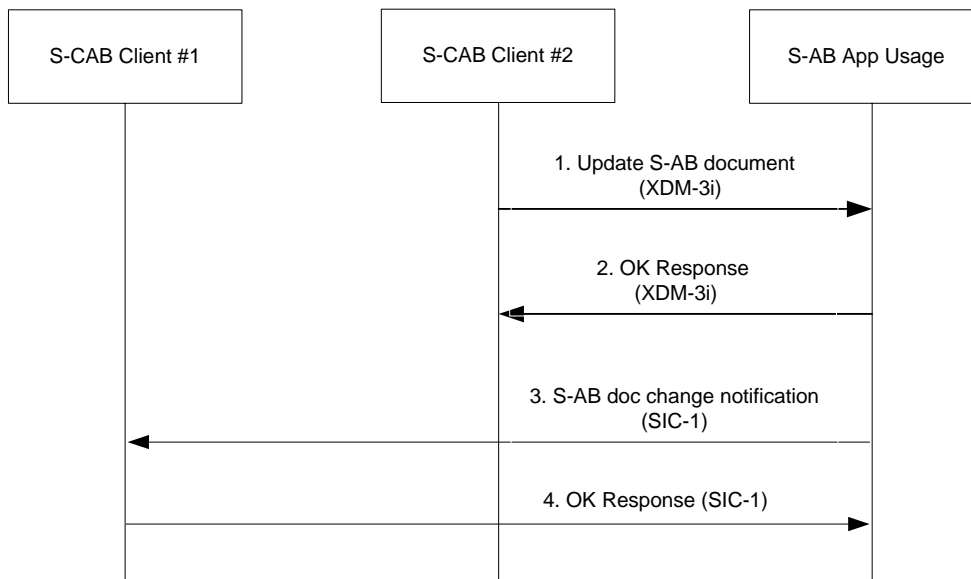

Figure 6: S-AB Data Sync scenario

Summary:

- Steps 1&2: S-CAB Client #1 updates the S-AB document associated with the contact
- Steps 3&4: S-CAB Client #2 receives a document change notification and updates its local S-AB document copy.

B.2.2 Flow 2: S-AB Data Sync scenario when S-CAB UE out of radio coverage, catch-up, and subscription restart

Prerequisites:

- The S-CAB Client #1 has previously subscribed to document changes for the S-CAB User’s S-AB Documents in the S-AB Application Usage User Directory.
- The S-CAB Client #1 has up-to-date ETags for all S-AB Documents.
- The S-CAB User is changing contact information for a contact with an existing S-AB document using S-CAB Client #2.

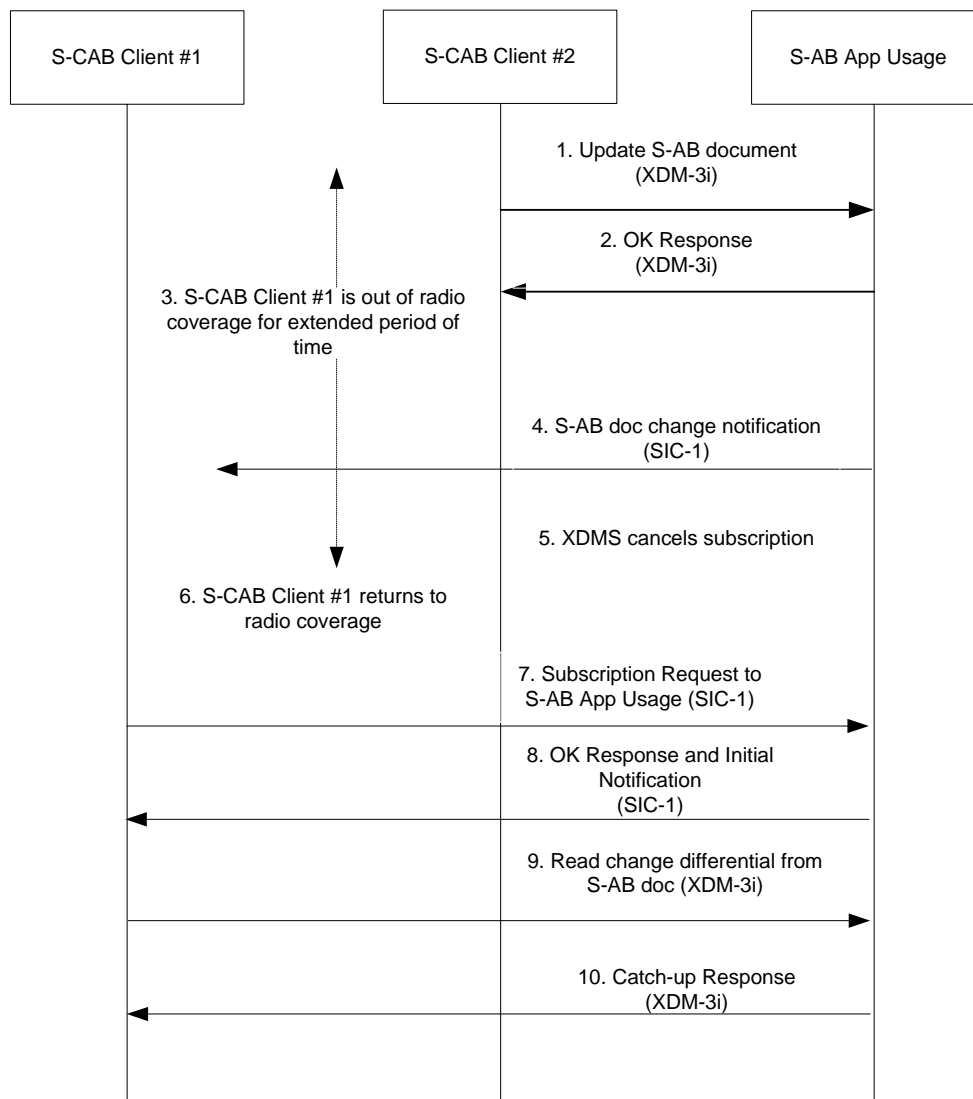

Figure 7: Data Sync scenario with catch-up

Summary:

- Steps 1&2: S-CAB Client #2 successfully updates the S-AB document associated with the contact.
- Step 3: The S-CAB Client #1 is out of radio coverage.
- Steps 4: S-AB Application Usage sends document change notification, but S-CAB Client #1 does not receive the notification. The S-CAB Client #1 now has an invalid ETag for one of its S-AB Documents.
- Step 5: S-AB Application Usage cancels the document change subscription for the S-CAB Client #1.

- Step 6: S-CAB Client #1 returns to radio coverage.
- Steps 7&8: S-CAB Client #1 starts a document change subscription targeting the S-CAB User's S-AB documents. The ETag value associated with the updated contact's S-AB document in the initial notification has a different value than the one in S-CAB Client #1. I.e. the S-CAB Client's S-AB Document copy is out of date.
- Steps 9&10: S-CAB Client #1 uses XDCP Differential Read to retrieve a catch-up difference based on the invalid ETag. S-CAB Client #1 receives the differential and applies it to its local S-AB document copy. S-CAB Client #1 now has a valid ETag and has an up to date copy of the contact's S-AB document.

B.3 S-PCC Authorization Flows

Flow 1: S-PCC Reactive Authorization Flow

Flow 2: Automatic authorization for access to S-CAB User's S-PCC document.

Notes:

- XDM proxies are not shown.

B.3.1 Flow 1: Reactive authorization for access to S-CAB User's S-PCC

S-CAB User #1 sets access permissions for contact details in the S-PCC Access Permission document, blocking access from S-CAB User #2.

Prerequisites:

- S-CAB User #1 is using S-CAB Client #1 and S-CAB User #2 is using S-CAB Client #2.
- S-CAB Client #1 has up-to-date ETag for the S-PCC document and supporting documents in the S-PCC Application Usage.
- The S-CAB Client #1 has a subscription to the Request History document in the S-PCC Application Usage.
- S-CAB User #1 has set their S-PCC XDM Preferences to record authorized and unauthorized requests in the Request History document.

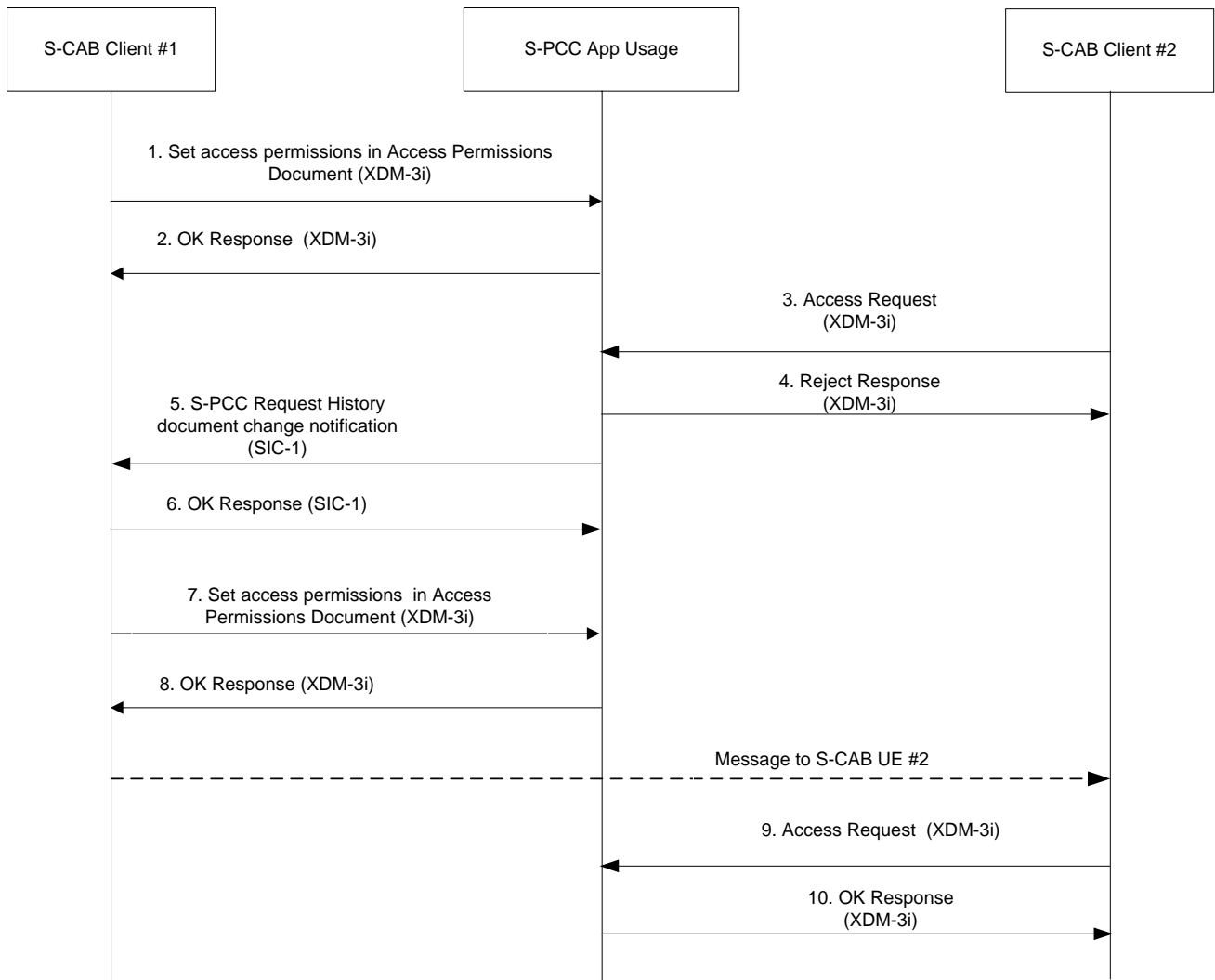

Figure 8: Reactive authorization

- Summary:
 - Steps 1&2: S-CAB Client #1 sets access permissions to S-CAB User #1’s personal contact information in the Access Permissions Document in the S-PCC Application Usage. By assumption the settings do not allow S-CAB User #2 to access, search, or subscribe to the S-PCC document of S-CAB User #1.
 - Steps 3&4: S-CAB Client #2 attempts to access, search, or subscribe to the S-PCC document of S-CAB Client #1. The request fails.
 - Steps 5&6: S-CAB Client #1 receives S-PCC Request History document change notification containing the failed attempt of S-CAB Client #2 (e.g., result is “unauthorized” for a read attempt due to an access permission rule did not include an <allow-retrieve> element).
 - Steps 7&8: S-CAB Client #1 sets the permissions to allow access to S-CAB User#2 (e.g., includes <allow-retrieve> element applicable to the requesting S-CAB User). S-CAB Client #1 sends an indication (shown as a message) to S-CAB Client 2 that the access permissions have been adjusted to allow access to S-CAB Client #2.
 - Steps 9&10: S-CAB Client #2 is able to access, search, or subscribe to the S-PCC document of S-CAB User #1 S-PCC document, and the request succeeds.

Note: If S-CAB User #1 does not want to provide access to S-CAB User #2, then S-CAB User #1 does not change the access permissions. Furthermore, S-CAB User #1 can permanently block S-CAB User #2's access request to be recorded in the Request History Document via use of a blacklist associated with Request History in the S-PCC XDM Preferences.

B.3.2 Flow 2: Automatic authorization for access to S-CAB User's S-PCC

S-CAB Client #1 sets access permissions for contact details in the S-PCC Access Permission document that allows S-CAB Client #2 to establish an XDM document change subscription to the S-PCC document

Prerequisites:

- S-CAB User #1 is using S-CAB Client #1 and S-CAB User #2 is using S-CAB Client #2.
- S-CAB Client #1 has up-to-date ETag for the S-PCC and supporting document.
- The S-CAB Client #1 has a subscription to the S-PCC Request History document

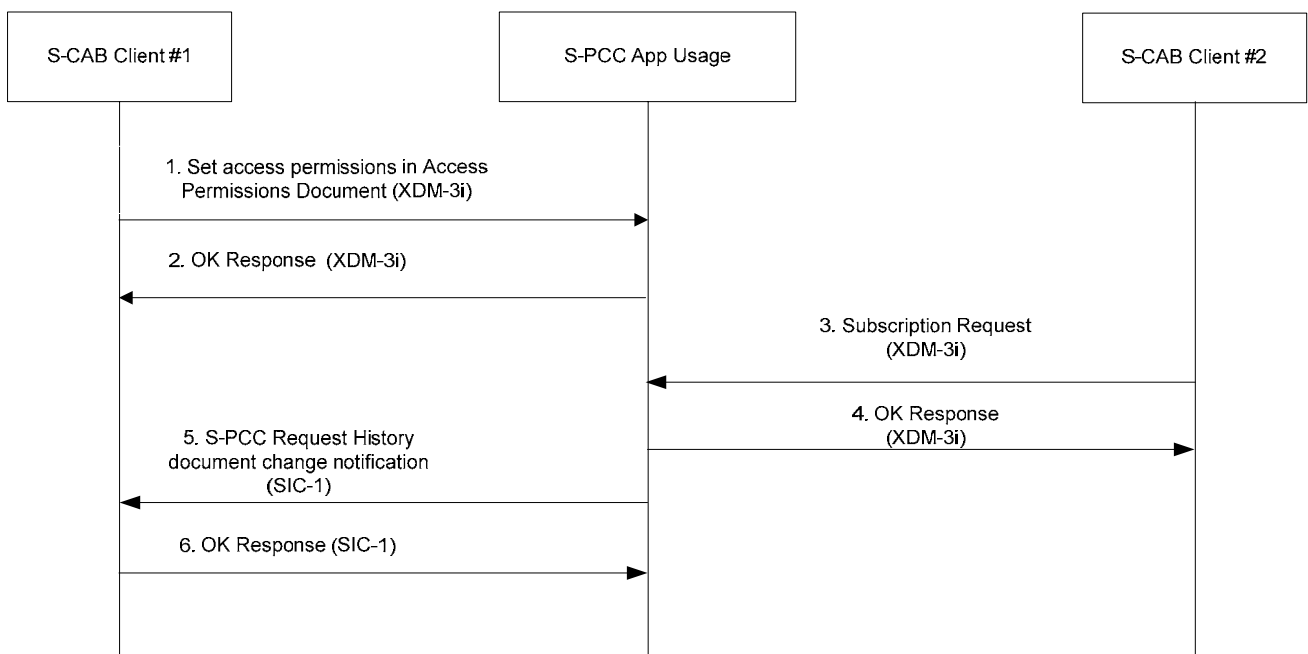

Figure 9: Automatic authorization

- Summary:
 - Steps 1&2: S-CAB Client #1 sets access permissions to S-CAB User #1's personal contact information in the Access Permissions Document in the S-PCC Application Usage. By assumption the settings do allow S-CAB User #2 to access, search, or subscribe to the S-PCC document of S-CAB User#1.
 - Steps 3&4: S-CAB Client #2 requests a document change subscription to the S-PCC document of S-CAB User #1. The request succeeds because S-CAB User #2 has been preauthorized.
 - Steps 5&6: S-CAB Client #1 receives S-PCC Request History document change notification containing the successful subscription of S-CAB Client #2.

B.4 Contact Share Scenario Flows

Flow 1: S-CAB User Contact Share to another S-CAB User

Flow 2: S-CAB User Contact Share to a Non-(S-)CAB User.

Flow 3: CAB User Contact Share of address book contact information to an S-CAB User.

Notes:

XDM proxies are not shown.

B.4.1 Flow 1: S-CAB User Contact Share to another S-CAB User

Please refer to the informative flow of "Figure C.24 - XDM Forward Example Flows" in Annex C.8.7 "Forwarding XDM Resources" of [OMA XDM Core], substituting "PCC XDMS" for "Group XDMS" in the scenario

B.4.2 Flow 2: S-CAB User Contact Share to a Non-(S-)CAB User

Prerequisites:

- An S-CAB User is using S-CAB Client A.
- The S-CAB User requests that his/hers personal contact information store in an S-PCC Document is sent to User B.
- User B is a Non-CAB User.

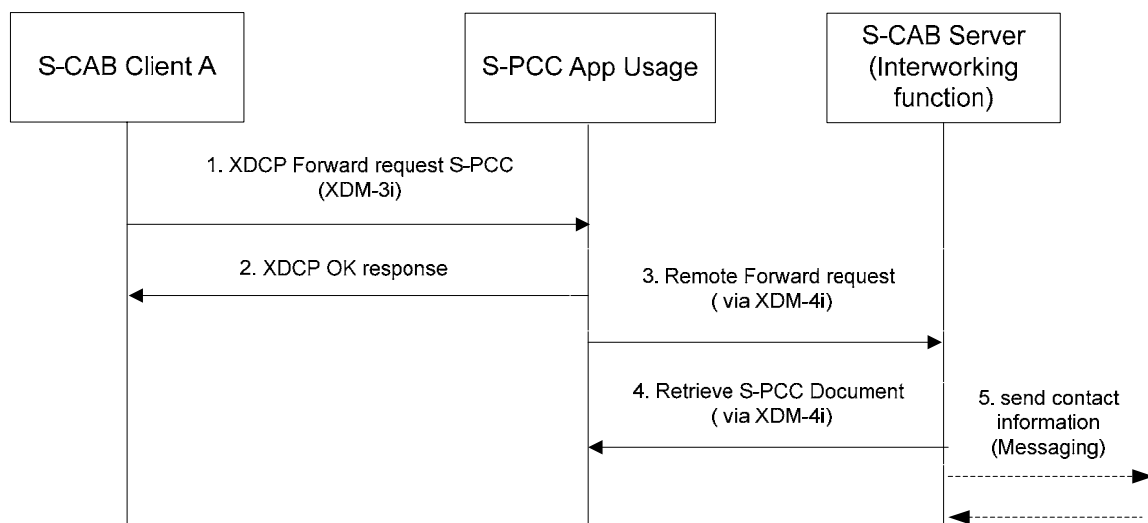

Figure 10: S-CAB User Contact Share to a Non-(S-)CAB User

- Summary:
 - Steps 1&2: S-CAB Client forwards PCC contact card or fragment to a Non-(S-)CAB User. The XDCP Forward request goes to the S-CAB User's PCC Application Usage.
 - Step 3: The S-PCC Application Usage finds that the remote user is not a CAB user (e.g., receives a 404 "Not Found") and sends a Remote-Forward Request to the S-CAB User's Server (Interworking function).
 - Step 4: The S-CAB server retrieves the temporary S-PCC Document using the link in the Remote-Forward Request.
 - Step 5: The S-CAB Server performs contact forwarding on interfaces (out of scope)
 - Subsequent steps: Normal forwarding where the S-CAB Server (Interworking function) is acting as a remote XDMS

Note: Contact Share of contact information an S-CAB User’s address book is done in the same way as Contact Share of personal information in an S-PCC Document shown in this flow.

B.4.3 Flow 3: CAB User Contact Share to an S-CAB User

Prerequisites:

- The S-CAB domain supports interoperability with the CAB domain, and the S-CAB Server implements part of the AB Application Usage described in [CAB AD].
- The XDM Aggregation Proxy is configured to route CAB AB requests to the S-AB Server.

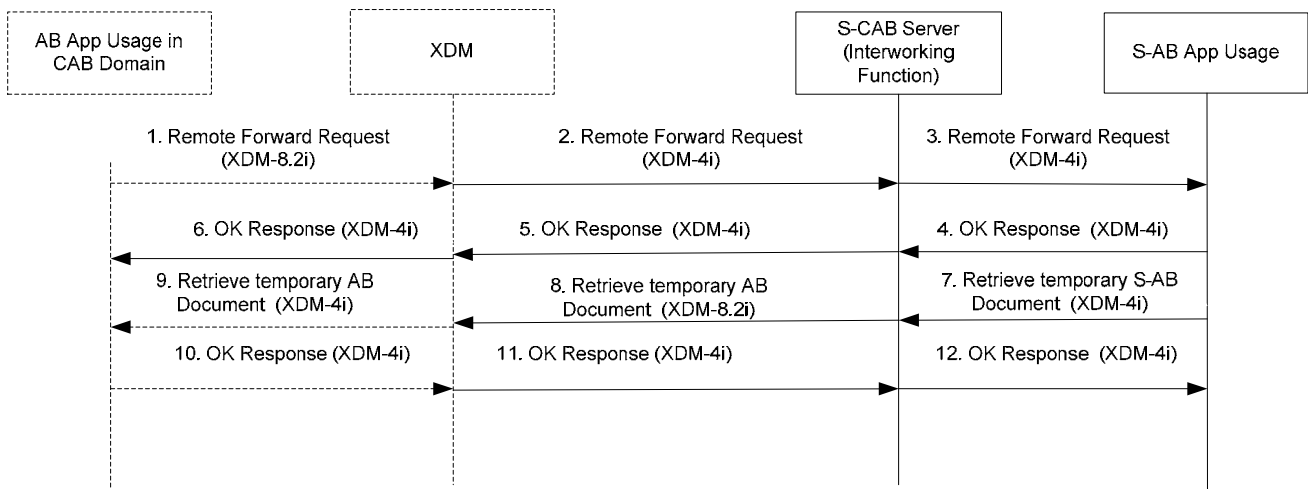

Figure 11: CAB User Contact Share to an S-CAB User

- Summary:
 - Step 1 Remote-Forward request arrives from remote AB Application Usage in remote CAB Domain to S-CAB Domain
 - Step 2: The XDM Enabler in the S-CAB Domain routes the Remote-Forward request to the S-CAB Server as the S-CAB Server’s XDMS function implement parts of the AB Application Usage.
 - Step 3: The S-CAB Server translates the Remote-Forward request received, to a Remote-Forward request targeting the S-AB Application Usage and sends the request to the S-AB Application Usage. The S-CAB Server has store the link to the temporary document received in step 2 and instead inserts a link that points to a temporary storage in the S-CAB server in the request targeting the S-AB Application Usage.
 - Steps 4&5&6: The positive response is sent back to the AB Application Usage in the CAB Domain via the S-CAB Server.
 - Step 7: The S-AB Application Usage retrieves the temporary document using the link in the Remote-Forward request in step 3.
 - Step 8: The CAB Server retrieves the document using the link that it has stored in step 3.
 - Steps 9&10&11: The retrieve request is send to the AB Application usage and a response with the temporary AB Document is returned to the S-CAB Server.
 - Step 12: The S-CAB server translate the received AB Document to the format of an S-AB Document and sends it to the S-AB Application Usage.

Note: Contact Share of contact information in an S-CAB User address book with a CAB User is following the same principle as in this flow, but in the opposite direction. This means that the S-AB Application Usage will send the Remote-Forward request to the S-CAB Server if it detects that the target is a CAB User in a remote CAB Domain and that the S-CAB Server will do the interworking between the two Application Usages.

B.5 Import, Export, Subscription from/to Non-CAB System Scenarios Flows

Flow 1: S-CAB User imports contact information from a Non-CAB System into S-AB Application Usage

Flow 2: S-CAB User imports profile information from a Non-CAB System into S-PCC Application Usage

Flow 3: S-CAB User exports its own contact information to a Non-CAB System

Notes:

XDM proxies are not shown.

B.5.1 Flow 1: S-CAB User imports contact information from Non-CAB System into S-AB Application Usage

Prerequisites:

- S-CAB User requests the S-CAB Client to import contact information from a Non-CAB System to be stored in an existing Confirmed Contact Card in the S-AB Application Usage.
- The S-CAB User Preferences for import of contact information into the S-AB Application Usage is set to automatic update of Confirmed Contact Cards.
- The S-CAB Client has a subscription to document changes in the S-CAB User's S-AB Application Usage User Directory.

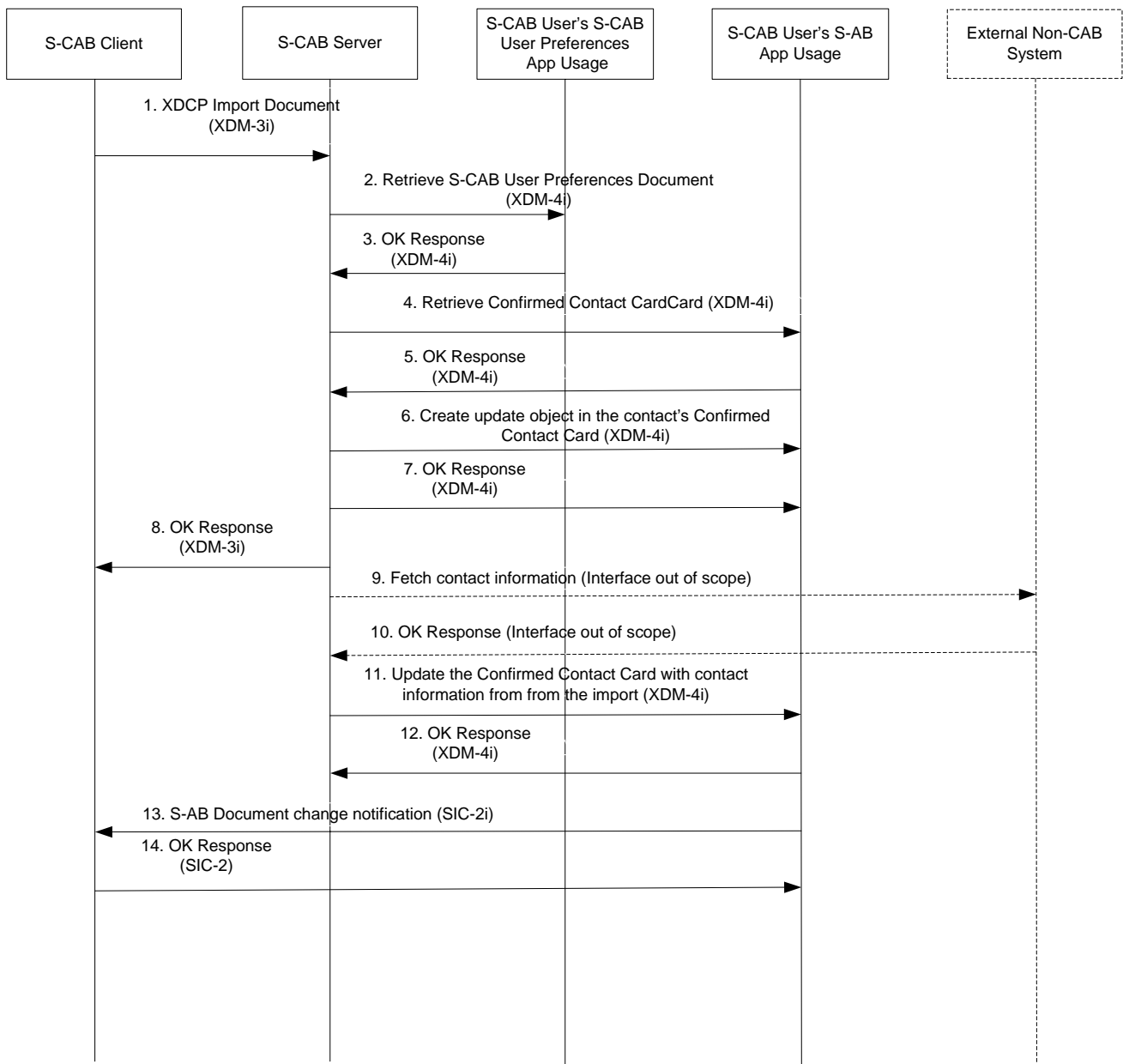

Figure 12: S-CAB User imports contact information from Non-CAB System into S-AB Application Usage

- Summary:
 - Step 1: S-CAB Client requests import via XDCP request.
 - Steps 2&3: S-CAB Server fetches the S-CAB User Preferences document to check if manual or automatic approval shall be applied for import of contact information.
 - Steps 4&5: S-CAB Server fetches the latest version of S-CAB Confirmed Contact Card document.
 - Steps 6&7: S-CAB Server updates the Confirmed Contact Card with an update object associated with the import.
 - Step 8: S-CAB Server sends the response to the import request to the S-CAB Client.
 - Steps 9&10: S-CAB Server's Interworking function retrieves contact information from Non-CAB System
 - Steps 11&12: S-CAB Server updates the Confirmed Contact Card with the imported contact information.

- Steps 13&14: The S-CAB client is notified via a XDM document change notification that the Confirmed Contact Card is updated with contact information from the import.

B.5.2 Flow 2: S-CAB User imports to profile information from Non-CAB System into S-PCC Application Usage

Prerequisites:

- S-CAB User requests the S-CAB Client to import (or subscription to) profile information from a Non-CAB System to be stored in an existing Confirmed Contact Card in the S-PCC Application Usage.
- The S-CAB User Preferences for import of profile information into the S-PCC Application Usage is set to automatic update of Confirmed Contact Cards.
- The S-CAB Client has a subscription to document changes in the S-CAB User's S-PCC Application Usage User Directory.

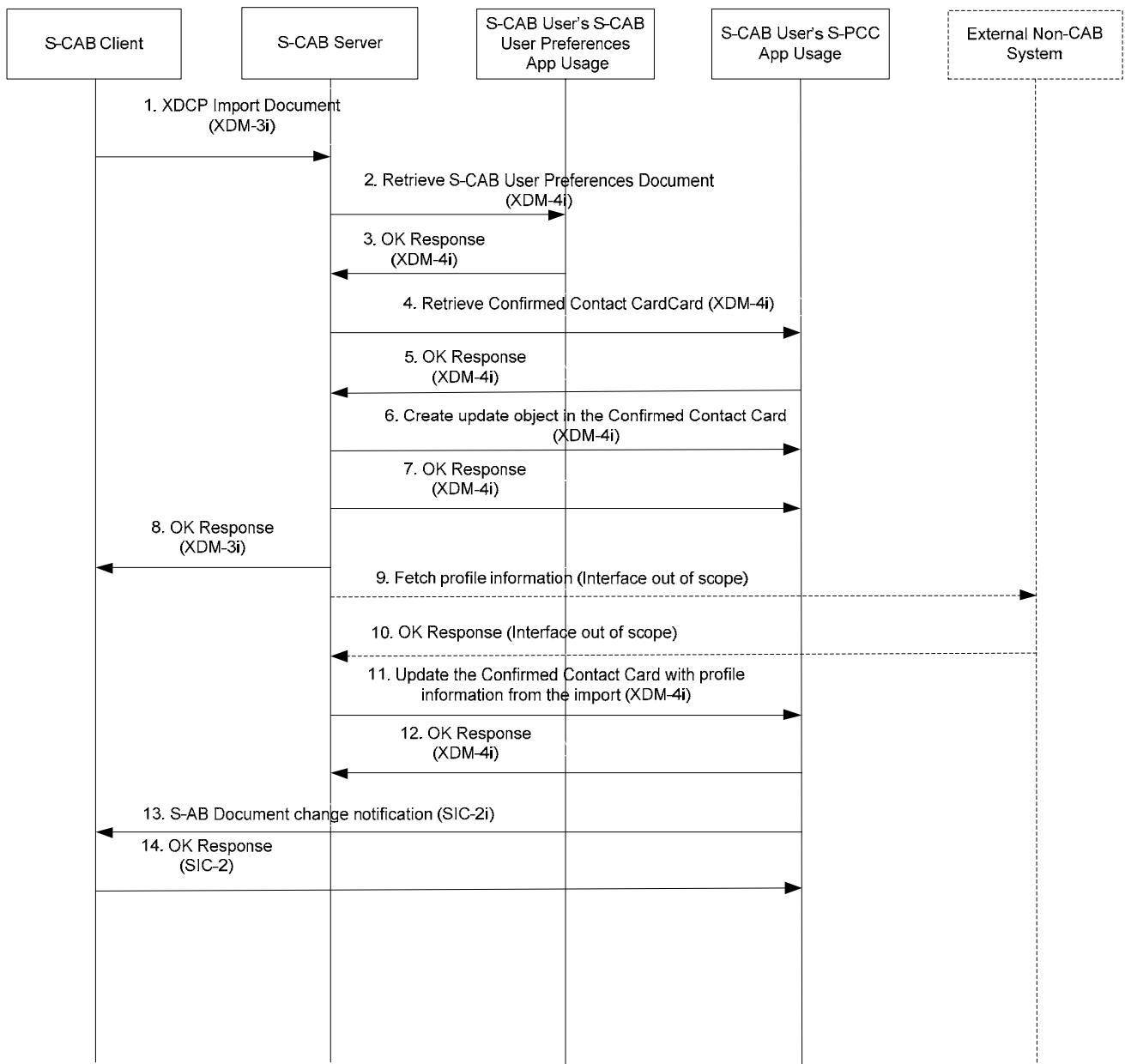

Figure 13: S-CAB User imports profile information from Non-CAB System into S-PCC Application Usage

- Summary:
 - Step 1: S-CAB Client requests import via XDCP request.
 - Steps 2&3: S-CAB Server fetches the S-CAB User Preferences document to check if manual or automatic approval shall be applied for import of profile information.
 - Steps 4&5: S-CAB Server fetches the latest version of S-CAB Confirmed Contact Card document.
 - Steps 6&7: S-CAB Server updates the Confirmed Contact Card with an update object associated with the import.
 - Step 8: S-CAB Server sends the response to the import request to the S-CAB Client.
 - Steps 9&10: S-CAB Server's Interworking function retrieves profile information from Non-CAB System. In case the S-CAB user requests to subscribe to the profile information at the Non-CAB System instead of a one-time import then these steps should be instead a subscription request, followed by an acknowledge from the Non-CAB System, and a series of change notifications. Following steps will take place upon receiving each of these subsequent notifications.

- Steps 11&12: S-CAB Server updates the Confirmed Contact Card with the imported profile information.
- Steps 13&14: The S-CAB client is notified via a XDM document change notification that the Confirmed Contact Card is updated with profile information from the import.

B.5.3 Flow 3: S-CAB User exports its own contact information to a Non-CAB System

Prerequisites:

- S-CAB User requests the S-CAB Client to export its contact information to an external profile that he has in a Non-CAB System.

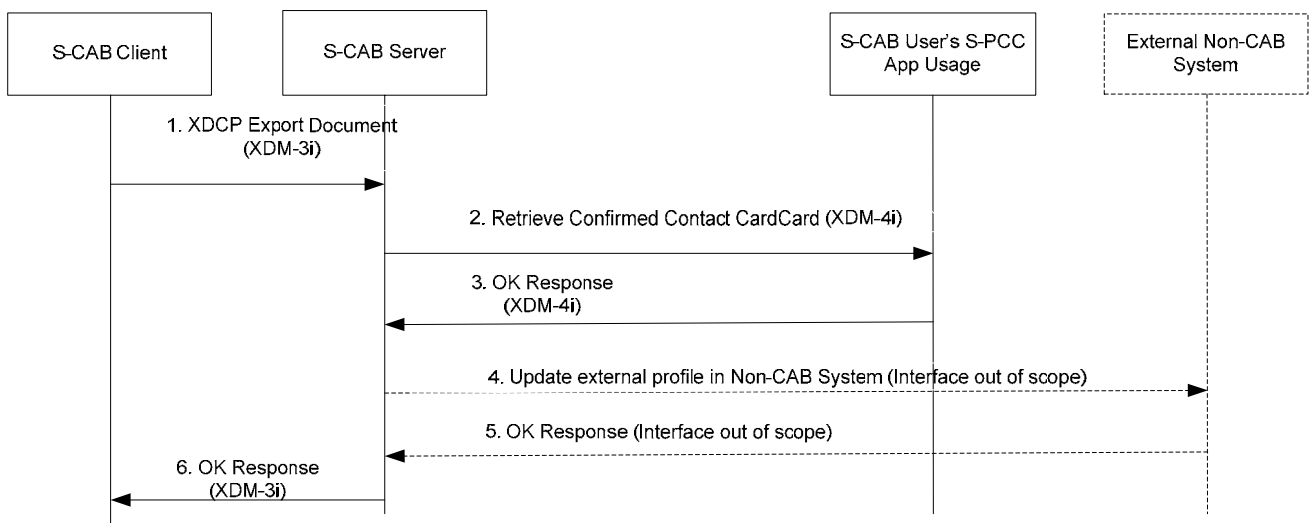

Figure 14 S-CAB User exports contact information to external profile in Non-CAB System

- Summary:
 - Step 1: S-CAB Client requests export via XDCP request.
 - Steps 2&3: S-CAB Server fetches the latest version of S-CAB Confirmed Contact Card document.
 - Steps 4&5: S-CAB Server updates the external profile in the Non-CAB System.
 - Step 6: S-CAB Server send the result of the export back to the S-CAB Client.

B.6 External Search Flows

Flow 1: Contact Search – External Directories

B.6.1 Flow 1: Contact Search – External Directories

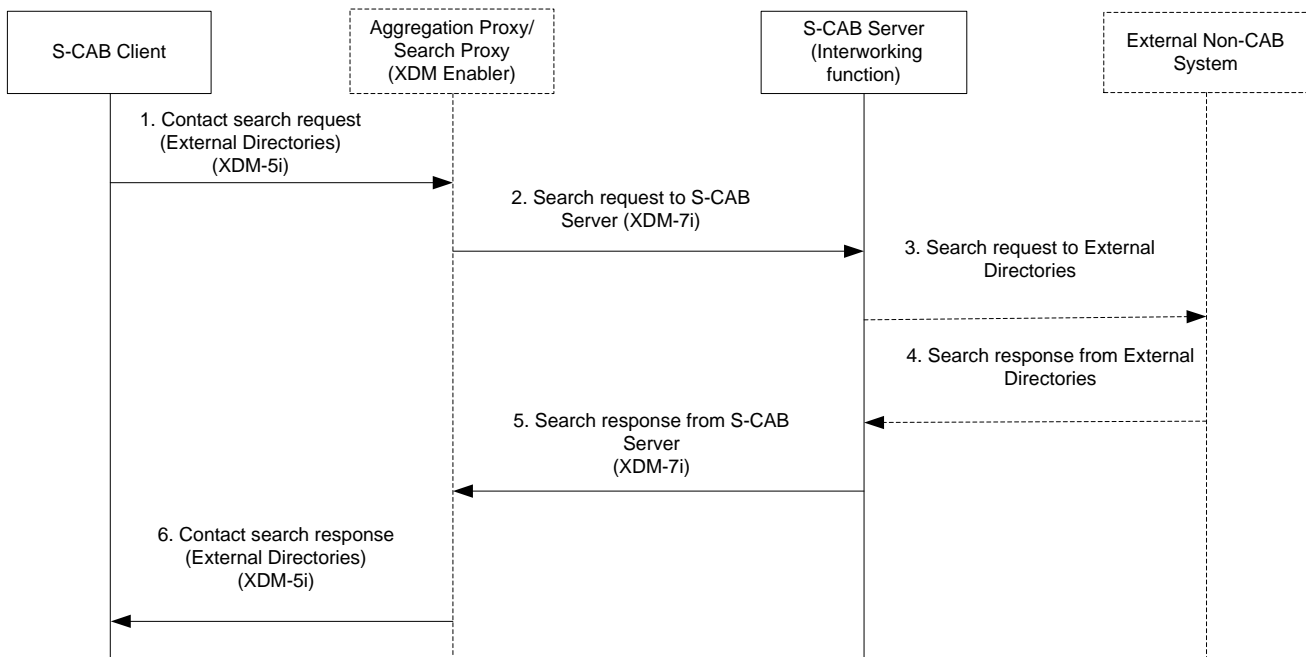

Figure 15 Contact Search – External Directories

Step 1: The S-CAB Client makes a contact search request towards External Directories via the Aggregation/Search Proxy using Limited XQuery. The request is formulated based on the standard XML search format (for External directories) hosted by the S-CAB Server's Interworking Function.

Step 2: Upon receiving the contact search request, the Search Proxy routes the request to the S-CAB Server (i.e. Interworking Function) as indicated in the original request via XDM-7i. The Interworking Function translates the standard XML search request to external search request. The interactions and mapping between standard XML search request and external search request is out of scope.

Step 3: The Interworking Function initiates the translated search request(s) to the External Directories over the appropriate interface(s). The translation and initiation of search requests over such external interfaces is out of scope of this specification.

Step 4: The search responses from the External Directories are received by the Interworking Function. If more than one search responses are received, the Interworking Function shall aggregate all responses into one search result. The aggregation of responses based on the external interfaces and data models is out of scope of this specification.

Step 5: The Interworking Function returns the search result(s) from External Directories to the Search Proxy. The response is based on XDM-7i. The search result(s) may be further formatted or composed in the Search Proxy.

Step 6: The contact search response (External Directories) is sent back to the S-CAB Client and includes the result(s) corresponding to the initial search request in Step 1.

B.7 S-CAB Capability Flows

The following provides three basic message flows for exchange of S-CAB capability information based on the Presence Enabler. The first two flows are different alternatives for the same functionality, namely the publication of the S-CAB Capability.

Flow 1: S-CAB Server publishes S-CAB capability as Permanent Presence State User

Flow 2: S-CAB Server publishes S-CAB capability as a regular SIP Publish

Flow 3: Flow 3: S-CAB Server subscribes to S-CAB Capability of its user's contacts.

Notes:

XDM proxies are not shown.

B.7.1 Flow 1: S-CAB Server publishes S-CAB capability as Permanent Presence State

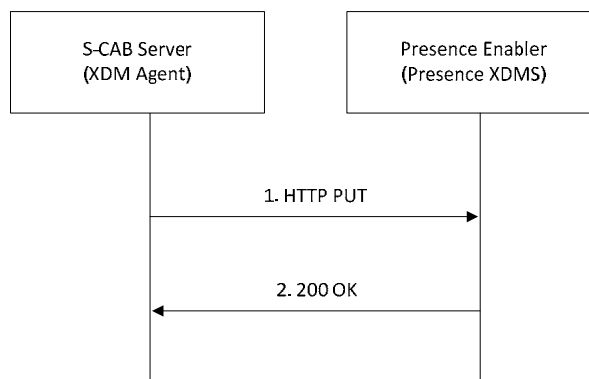

Figure 16: S-CAB Server publishes S-CAB capability

Step 1: A user becomes S-CAB User. The S-CAB Server through the XDM Agent updates the S-CAB capability of the new S-CAB User at that user's Permanent Presence State at the Presence Enabler (Presence XDMS).

Step 2: The response is sent back to the S-CAB Server.

B.7.2 Flow 2: S-CAB Server publishes S-CAB capability as a regular SIP Publish

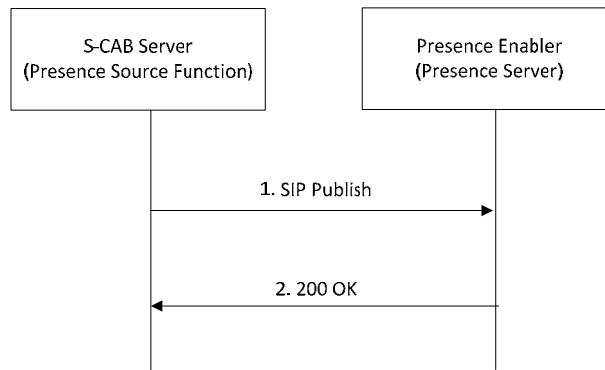

Figure 17: S-CAB Server subscribes to “CAB Capability”

Step 1: A user becomes S-CAB User. The S-CAB Server through the Presence Source Function publishes the S-CAB capability of the new S-CAB User to that user’s Presence Document at the Presence Enabler (Presence Server).

Step 2: The response is sent back to the S-CAB Server.

These requests are exchanged through the SIP/IP Core, which is not shown for simplicity

B.7.3 Flow 3: S-CAB Server subscribes to S-CAB Capability of its user’s contacts

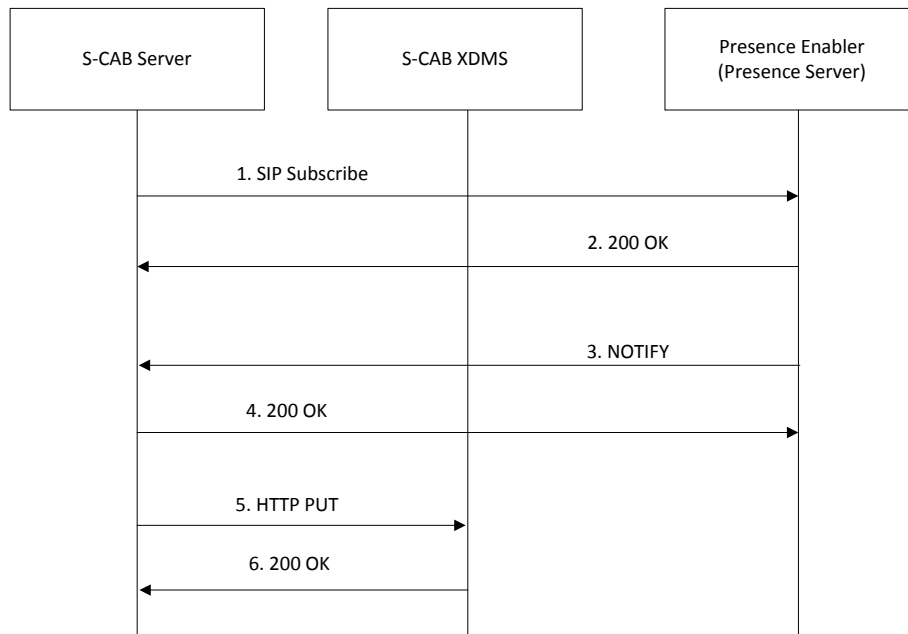

Figure 18: S-CAB Server subscribes to “CAB Capability”

Step 1: S-CAB server (Presence Watcher Function) subscribes to the Presence (S-CAB service tuple) of the contacts in the address book of each user it serves. This can be also incremental subscriptions (e.g. when a user adds a new contact). The subscription is performed by either of the following procedures:

Step 1a: individual subscriptions to each of the contacts in the address book of each of the users (with multiple subscriptions to a specific contact if included in the address books of more than one user)

Step 1b: single anonymous subscription for each contact included in at least one address book of the users served by that S-CAB server.

Step 2: The response is sent back to the S-CAB Server.

Step 3: A notification is received from the Presence Enabler, informing of a change in the S-CAB Service tuple of a subscribed contact. Multiple notifications for a single contact may be received if Step 1a was followed

Step 4: The response is sent back to the Presence Enabler.

Step 5: The S-CAB server (XDM Agent) updates the S-CAB XDMS, by updating the “contact type” (S-CAB/Non-S-CAB) of the corresponding contact in the address book of all the users with that specific contact in his/her address book, and subject to the information received in the notifications in Step 3 (e.g. no update will be performed in those users’ address book for which no notification was received, meaning the contact did not grant access to his/her Presence data)..

Step 6: The response is sent back to the S-CAB Server.

The SIP requests (steps 1, 2, 3 and 4) are exchanged through the SIP/IP Core, which is not shown for simplicity

B.8 Manual Approval of Confirmed Contact Card Changes

The S-CAB User manually accepts changes to a Confirmed Contact Card associated with imported and document change tracked contact data (external profile) in a Non-CAB System. In this scenario the user edits (personalizes) their confirmed contact card after various Non-CAB System import and notifications have occurred but before manually approving the changes to a Confirmed Contact Card on changes in the external profile

Notes:

- XDM proxies are not shown.

Prerequisites

- The S-CAB UE is assumed to have an existing document change subscription to the S-CAB User's S-PCC document, is up-to-date, and possesses an up-to-date ETag.

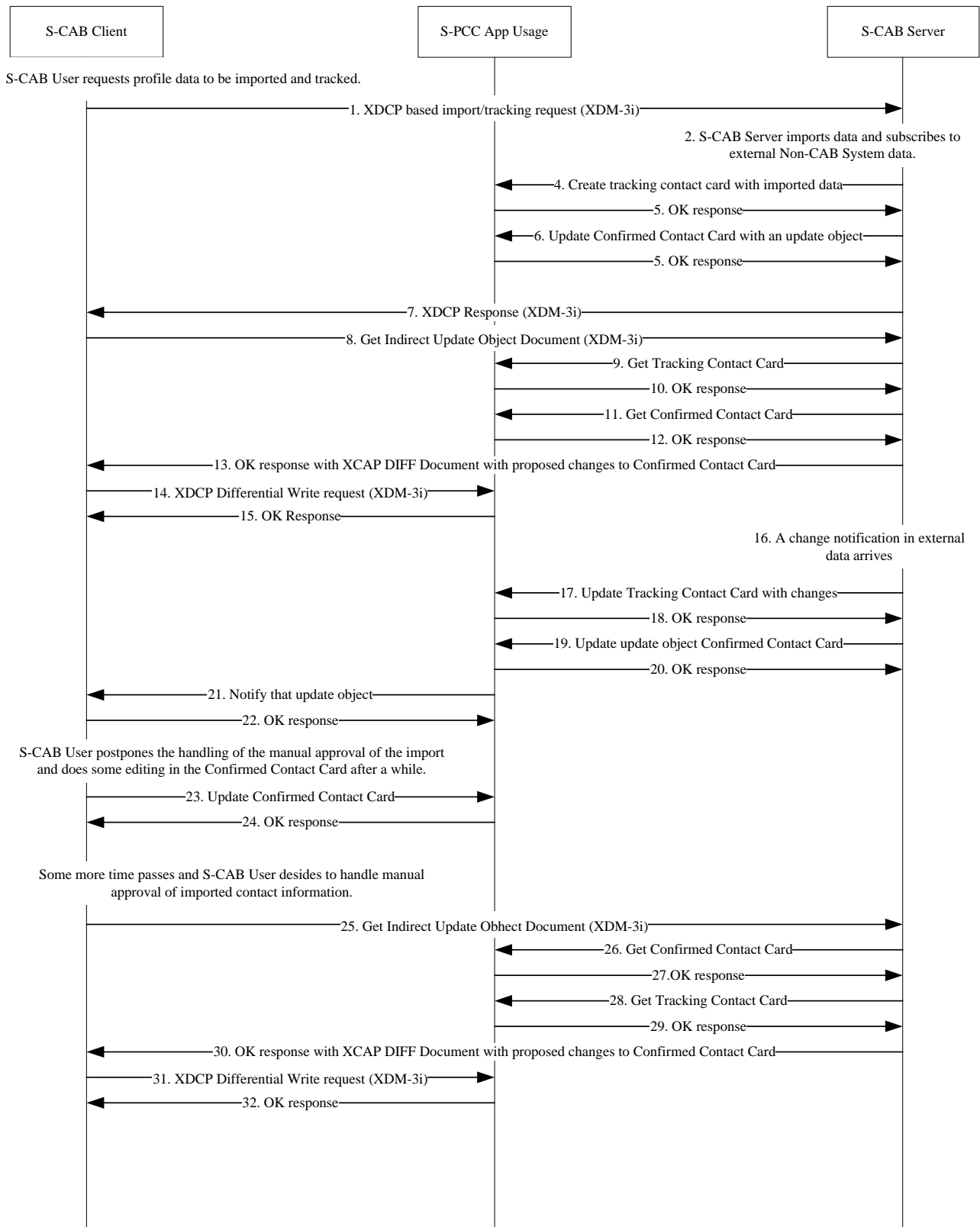

Figure 19: Manual Approval of Changes to Confirmed Contact Card Data

- Step 1: The S-CAB Client sends XDCP Request commanding the S-CAB Server to import/track contact information from a 3rd Party source.
 - Step 2: The S-CAB Server imports and subscribes to contact data in the identified Non-CAB System source. This occurs over interfaces outside the scope of S-CAB specifications.
 - Steps 3&4: The S-CAB Server creates a tracking contact card with the initially imported data from the Non-CAB System source.
 - Steps 5&6: The S-CAB Server creates Update Object with meta-information for this Tracking Contact Card in the S-PCC Confirmed Contact Card document The Update Object contains a link to an Indirect Update Document as manual approval of changes to the Confirmed Contact Card has been requested.
 - Step 7: The S-CAB Server sends success response in response to the XDCP import/tracking command to the S-CAB Client. The response includes a link to an Indirect Update Document as manual approval is selected for this import.
 - Step 8: The S-CAB User decides to handle to approval immediately and the S-CAB Client send a Get request to retrieve the Indirect Update Document with the result of the import. I.e. to retrieve the difference between the Confirmed Contact Card and the imported contact information.
 - Steps 9, 10, 11&12: The S-CAB Server fetches the Tracking Contact Card and the Confirmed Contact Cards associated with the Indirect Update Document requested.
 - Step 13: The S-CAB Server sends a response to the Get request that includes a body with a number of patches to the Confirmed Contact Card. The patches describe the difference between imported contact information and contact information in the Confirmed Contact Card.
 - Steps 14&15: The S-Client presents the proposed changes to the S-CAB User using the patches received. The S-CAB User selects which changes to the Confirmed Contact Card he/she wants to approve. The S-CAB Client removes unwanted changes to the Confirmed Contact Card by removing corresponding patches from the received Indirect Update Object Document and sends a Differential Write request with the modified Indirect Update Object Document included.
 - Step 16: After some time, a change notification arrives to the S-CAB Server indicating a document change in the Non-CAB System source.
 - Steps 17&18: The S-CAB Server updates the Tracking Contact Card based on the incoming document change notification.
 - Steps 19&20: The S-CAB Server updates the update object in the Confirmed Contact Card with a link to an Indirect Update Object Document as manual approval has been selected for the import.
 - Steps 21&22: The S-PCC Application Usage sends a notification with information about the modified update object in the Confirmed Contact Card.
- Note: It is assumed that in this scenario, the S-CAB User has selected not to handle approval of imported information at this moment. Instead the S-CAB User modifies the Confirmed Contact Card with new contact information inserted via the S-CAB Client. The information received in step 21 is stored for later use
- Steps 23&24: The S-CAB User edits the confirmed contact card and the S-CAB Client updated the Confirmed Contact Card.
 - Step 25: The S-CAB User selects now to handle the imported contact information. The S-CAB Client send a Get request to read the Indirect Update Object Document using the link in the update object in the Confirmed Contact Card received in step 21.
 - Steps 26, 27, 28 &29: The S-CAB Server fetches the Tracking Contact Card and the Confirmed Contact Card associated with the requested Indirect Update Document.
 - Step 30: The S-CAB computes the changes against the confirmed contact card implied by changes to the tracking contact card, and places into the Indirect Update Object Document in XCAP-Diff object form and sends the document in the response to the S-CAB Client.
 - Steps 31&32: The S-Client presents the proposed changes to the S-CAB User. The S-CAB User selects which changes to the Confirmed Contact Card he/she wants to approve. The S-CAB Client removes unwanted changes to the Confirmed Contact Card by removing corresponding patches from the received Indirect Update Object Document and sends an

Differential Write request with the modified Indirect Update Object Document included. The S-CAB Client extracts the XCAP-Diff object, and applies the changes to a locally stored copy of the Confirmed Contact Card.

B.9 Contact Subscription Invitation

S-CAB User Contact Subscription Invitation to another S-CAB User

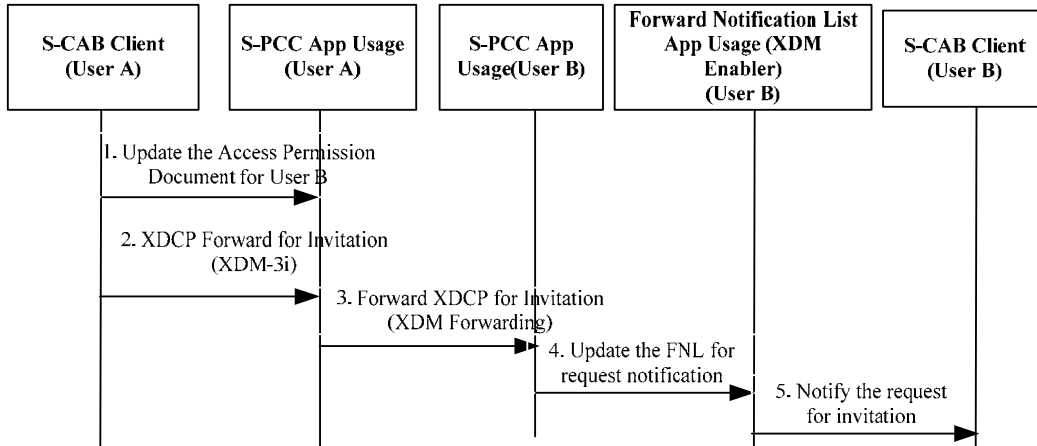

Figure 20: S-CAB User Contact Invitation to another S-CAB User

Summary

- Step 1: S-CAB Client of User A update access permission for S-CAB User B’s subscription.
- Step 2: S-CAB Client of User A sends XDCP Forward request for invitation.
- Step 3: S-CAB XDMS of User A generates XDCP Forward request for invitation and sends it to the receiving side.
- Step 4: S-CAB XDMS of User B updates the FNL for request notification.
- Step 5: S-CAB Client of User B is notified of the request for invitation.

The S-CAB User B may subscribe the S-CAB User A’s PCC based on the request notification.

B.10 S-CAB User Communication History handling

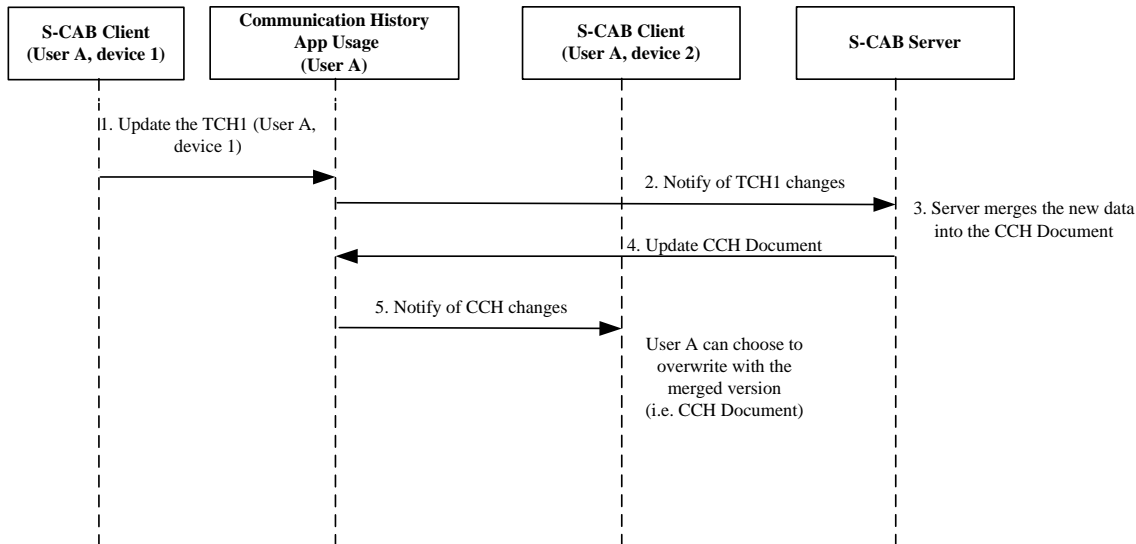

Figure 21: S-CAB User Communication History handling

Note: the S-CAB Clients on all UserA devices are assumed to be subscribed to XDM document changes of the Communication History Application Usage. The alternative is to have regular polling done from the S-CAB Client on each device for the latest documents in the Communication History Application Usage.

Summary:

- Step 1: S-CAB Client of User A on device 1 updates the Tracking Communication History Document for device 1 (TCH1) in the S-CAB XDMS;
- Step 2: the S-CAB Communication History Application Usage notifies the S-CAB Server of the TCH1 changes;
- Step3: S-CAB Server merges the changes into the CCH Document of User A and;
- Step 4: S-CAB Server stores the resulting data in the CCH Document in the Communication History Application Usage;
- Step 5: S-CAB XDMS of User A generates SIP Notify to S-CAB Client of User A on other user's devices, in this case device 2, to inform of changes done to CCH Document;

If the S-CAB User wishes to retrieve the merged Communication History and Usage Information on device 2 (i.e. the CCH document), the S-CAB Client on device 2 performs the adequate steps to obtain the up-to-date CCH document. Following user's choice to update device 2 with the CCH document, the S-CAB Client will delete the TCH2 document, if a previous TCH2 document was maintained for device 2 in the S-CAB Communication History Application Usage.

Appendix C. S-CAB Architecture Showing XDM Components (Informative)

The following architecture diagram is informative and provides additional details to the normative AD diagram of Figure 1, illustrating the internal logical functions within S-CAB entities, interactions to and from Non-S-CAB entities, and subcomponents of the XDM Enabler.

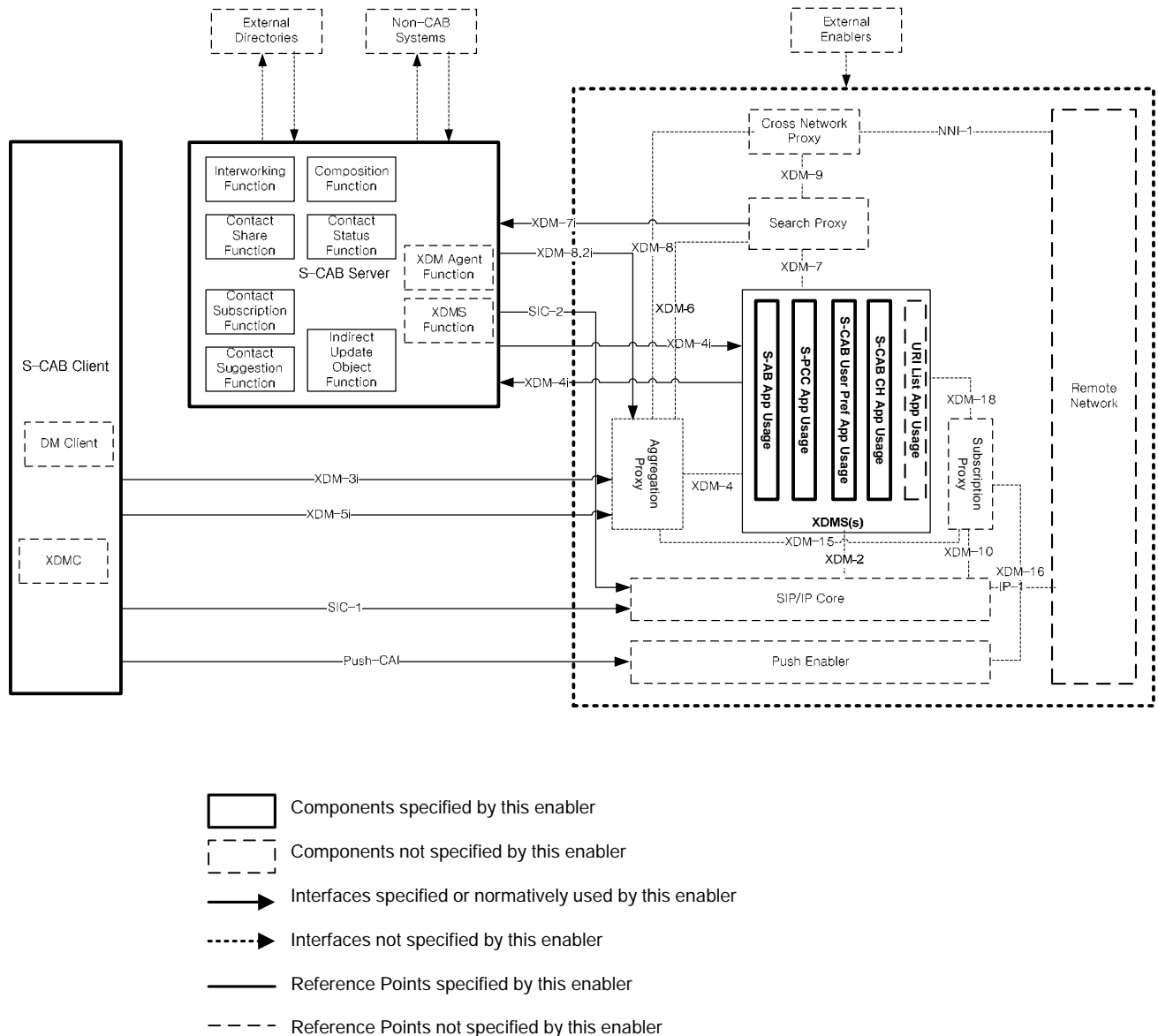

Figure 22: S-CAB Architecture Showing XDM Components (Informative)

The following architecture diagram is informative and provides additional architecture details for the case that the publication and discovery of contact's S-CAB capability (S-CAB / Non-S-CAB) is implemented based on the Presence Enabler. The interfaces from Fig. 2 are not shown in Fig. 3 for simplification.

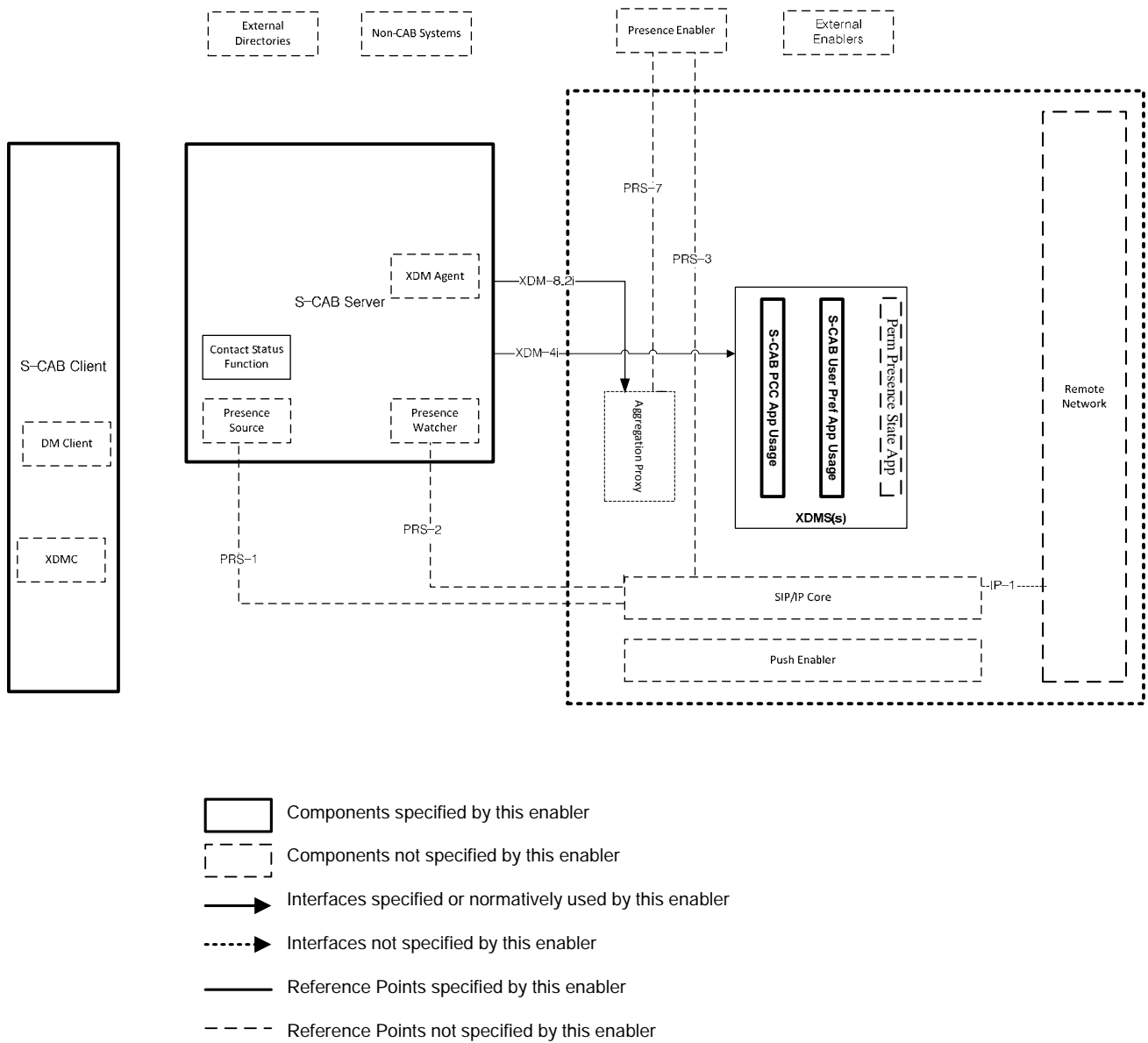

Figure 23: S-CAB Architecture Diagram depicting S-CAB Capability population based on the Presence Enabler (informative)