



PoC User Plane

Candidate Version 2.0 – 07 May 2008

Open Mobile Alliance
OMA-TS-PoC_UserPlane-V2_0-20080507-C

Use of this document is subject to all of the terms and conditions of the Use Agreement located at <http://www.openmobilealliance.org/UseAgreement.html>.

Unless this document is clearly designated as an approved specification, this document is a work in process, is not an approved Open Mobile Alliance™ specification, and is subject to revision or removal without notice.

You can use this document or any part of the document for internal or educational purposes only, provided you do not modify, edit or take out of context the information in this document in any manner. Information contained in this document can be used, at your sole risk, for any purposes. You can not use this document in any other manner without the prior written permission of the Open Mobile Alliance. The Open Mobile Alliance authorizes you to copy this document, provided that you retain all copyright and other proprietary notices contained in the original materials on any copies of the materials and that you comply strictly with these terms. This copyright permission does not constitute an endorsement of the products or services. The Open Mobile Alliance assumes no responsibility for errors or omissions in this document.

Each Open Mobile Alliance member has agreed to use reasonable endeavours to inform the Open Mobile Alliance in a timely manner of Essential IPR as it becomes aware that the Essential IPR is related to the prepared or published specification. However, the members do not have an obligation to conduct IPR searches. The declared Essential IPR is publicly available to members and non-members of the Open Mobile Alliance and can be found on the "OMA IPR Declarations" list at <http://www.openmobilealliance.org/ipr.html>. The Open Mobile Alliance has not conducted an independent IPR review of this document and the information contained herein, and makes no representations or warranties regarding third party IPR, including without limitation patents, copyrights or trade secret rights. This document can contain inventions for which you must obtain licenses from third parties before making, using or selling the inventions. Defined terms above are set forth in the schedule to the Open Mobile Alliance Application Form.

NO REPRESENTATIONS OR WARRANTIES (WHETHER EXPRESS OR IMPLIED) ARE MADE BY THE OPEN MOBILE ALLIANCE OR ANY OPEN MOBILE ALLIANCE MEMBER OR ITS AFFILIATES REGARDING ANY OF THE IPR'S REPRESENTED ON THE "OMA IPR DECLARATIONS" LIST, INCLUDING, BUT NOT LIMITED TO THE ACCURACY, COMPLETENESS, VALIDITY OR RELEVANCE OF THE INFORMATION OR WHETHER OR NOT SUCH RIGHTS ARE ESSENTIAL OR NON-ESSENTIAL.

THE OPEN MOBILE ALLIANCE IS NOT LIABLE FOR AND HEREBY DISCLAIMS ANY DIRECT, INDIRECT, PUNITIVE, SPECIAL, INCIDENTAL, CONSEQUENTIAL, OR EXEMPLARY DAMAGES ARISING OUT OF OR IN CONNECTION WITH THE USE OF DOCUMENTS AND THE INFORMATION CONTAINED IN THE DOCUMENTS.

© 2008 Open Mobile Alliance Ltd. All Rights Reserved.

Used with the permission of the Open Mobile Alliance Ltd. under the terms set forth above.

Contents

1.	SCOPE	9
2.	REFERENCES	9
2.1	NORMATIVE REFERENCES	9
2.2	INFORMATIVE REFERENCES	9
3.	TERMINOLOGY AND CONVENTIONS	9
3.1	CONVENTIONS	9
3.2	DEFINITIONS	9
3.3	ABBREVIATIONS	9
4.	INTRODUCTION	9
4.1	OVERVIEW	9
4.2	USER PLANE ROUTING	9
5.	TRANSPORT	9
5.1	INTERNET PROTOCOL	9
5.2	UDP	9
5.2.1	Port Numbers	9
5.3	RTP	9
5.4	RTCP	9
5.5	MSRP	9
6.	MEDIA BURST CONTROL	9
6.1	GENERAL	9
6.2	PROCEDURES AT THE PO C CLIENT	9
6.2.1	PoC Client procedures at PoC Session initialization	9
6.2.2	PoC Client procedures at Pre-established Session initialization	9
6.2.3	PoC Client procedures at PoC Session release.....	9
6.2.4	PoC Client procedures at Pre-established Session release	9
6.2.4A	PoC Client procedures at PoC Session modification	9
6.2.4A.1	PoC Client procedures when connecting to a Media Type.....	9
6.2.4A.2	PoC Client procedures when disconnecting from a Media Type	9
6.2.5	PoC Session control state diagram – basic.....	9
6.2.5.1	State 'Start-stop'.....	9
6.2.5.1.1	PoC Session initiated – originating PoC User.....	9
6.2.5.1.2	PoC Session established – terminating PoC User.....	9
6.2.5.1.3	Connecting to a Media-floor Control Entity during an ongoing PoC Session.....	9
6.2.5.2	State: 'U: has no permission'.....	9
6.2.5.2.1	Receive MBCP Media Burst Idle message (R: MB_Idle).....	9
6.2.5.2.2	Receive MBCP Media Burst Taken message (R: MB_Taken).....	9
6.2.5.2.3	Receive RTP Media packets (R: Media)	9
6.2.5.2.4	Send MBCP Media Burst Request message (S: MB_Request)	9
6.2.5.2.5	T13 (end of RTP Media) timer fired.....	9
6.2.5.2.6	Receiving a MSRP SEND request (R: MSRP SEND)	9
6.2.5.3	State: 'U: pending MB_Request'.....	9
6.2.5.3.1	Receive MBCP Media Burst Granted message (R: MB_Granted).....	9
6.2.5.3.2	Receive MBCP Media Burst Taken message (R: MB_Taken).....	9
6.2.5.3.3	Receive MBCP Media Burst Deny message (R: MB_Deny)	9
6.2.5.3.4	T11 (Media Burst request) timer fired.....	9
6.2.5.3.5	T11 (Media Burst request) timer fired N times.....	9
6.2.5.3.6	Receive RTP Media packets (R: Media)	9
6.2.5.3.7	Send MBCP Media Burst Release message (S: MB_Release)	9
6.2.5.3.8	Receiving a MSRP SEND request (R: MSRP SEND)	9
6.2.5.4	State: 'U: has permission'.....	9
6.2.5.4.1	Send RTP Media packets (S: Media).....	9
6.2.5.4.2	Send MBCP Media Burst Release message (S: MB_Release)	9
6.2.5.4.3	Receive MBCP Media Burst Revoke message (R: MB_Revoke)	9
6.2.5.4.4	T17 (Revocation Alert) timer expiry	9

6.2.5.4.5	Sending a MSRP SEND request (S: MSRP SEND).....	9
6.2.5.5	State: 'U: pending MB_Release'.....	9
6.2.5.5.1	T10 (Media Burst release) timer fired	9
6.2.5.5.2	T10 (Media Burst release) timer fired N times	9
6.2.5.5.3	Receive MBCP Media Burst Idle (R: MB_Idle).....	9
6.2.5.5.4	Receive MBCP Media Burst Taken message (R: MB_Taken).....	9
6.2.5.5.5	Receive RTP Media packets (R: Media).....	9
6.2.5.5.6	Receive MBCP Media Burst Revoke message (R: MB_Revoke).....	9
6.2.5.6	State: 'U: pending MB_Revoke'.....	9
6.2.5.6.1	Send RTP Media (S: Media).....	9
6.2.5.6.2	Receive MBCP Media Burst Idle message (R: MB_Idle).....	9
6.2.5.6.3	Receive MBCP Media Burst Taken message (R: MB_Taken).....	9
6.2.5.6.4	Receive RTP Media (R: Media).....	9
6.2.5.6.5	Send MBCP Media Burst Release message (S: MB_Release).....	9
6.2.5.6.6	Receiving a MSRP SEND request (R: MSRP SEND).....	9
6.2.5.7	State: Any state.....	9
6.2.5.7.1	Receive MBCP Disconnect message (R: Disconnect)	9
6.2.5.7.2	Receive PoC Session release – 1 (R: PoC Session release - 1).....	9
6.2.5.8	State: 'Releasing'.....	9
6.2.5.8.1	Receive PoC Session release – 2 (R: PoC Session release - 2).....	9
6.2.5.9	State: 'U: Permission to send limited segment'.....	9
6.2.5.9.1	Enter State U: Permission to send limited segment	9
6.2.5.9.2	Send RTP Media packets (S: Media).....	9
6.2.5.9.3	Receive MBCP Media Burst Revoke message (R: MB_Revoke).....	9
6.2.5.9.4	Receive MBCP Media Burst Granted message (R: MB_Granted).....	9
6.2.5.9.5	T21 (Limited Media Segment) timer fired	9
6.2.5.9.6	T21 (Limited Media Segment) timer fired M times	9
6.2.5.9.7	Send MBCP Media Burst Release message (S: MB_Release).....	9
6.2.5.10	State: 'U: Local Grant'.....	9
6.2.5.10.1	Receive MBCP Media Burst Granted message (R: MB_Granted).....	9
6.2.5.10.2	Receive MBCP Media Burst Taken message (R: MB_Taken).....	9
6.2.5.10.3	Receive MBCP Media Burst Deny message (R: MB_Deny)	9
6.2.5.10.4	T11 (Media Burst request) timer fired.....	9
6.2.5.10.5	T11 (Media Burst request) timer fired N times.....	9
6.2.5.10.6	Receive RTP Media packets (R: Media).....	9
6.2.5.10.7	Send MBCP Media Burst Release message (S: MB_Release).....	9
6.2.5.10.8	Send RTP Media packets (S: Media).....	9
6.2.6	PoC Session control state diagram – Pre-established Session	9
6.2.6.1	State 'Start-stop'	9
6.2.6.1.1	Pre-established Session started	9
6.2.6.2	State 'U: Pre-established Session_Not_in_use'.....	9
6.2.6.2.1	Receive MBCP Connect message (R: Connect)	9
6.2.6.2.2	Void.....	9
6.2.6.2.3	Receive SIP 202 "Accepted" response (R: 202 ACCEPTED (CP)).....	9
6.2.6.2.4	Pre-established Session stopped.....	9
6.2.6.2.5	Void.....	9
6.2.6.2.6	Receive MBCP Disconnect (R: Disconnect).....	9
6.2.6.2.7	Send SIP 200 "OK" response to the SIP re-INVITE request (S: 200 OK (CP))	9
6.2.6.3	State 'U: Pre-established Session_In_use'.....	9
6.2.6.3.1	Receive MBCP Connect message (R: Connect)	9
6.2.6.3.2	Receive other MBCP message (R: MBCP message).....	9
6.2.6.3.3	Receive RTP Media packets (R: Media).....	9
6.2.6.3.4	Receive SIP 202 "Accepted" (R: 202 ACCEPTED (CP))	9
6.2.6.3.5	Send MBCP message (S: MBCP message).....	9
6.2.6.3.6	Send RTP Media packets (S: Media).....	9
6.2.6.3.7	Receive MBCP Disconnect (R: Disconnect).....	9
6.2.6.3.8	Receive a MSRP SEND request (R: MSRP SEND).....	9
6.2.6.3.9	Send a MSRP SEND request (S: MSRP SEND).....	9
6.2.7	PoC Session control state diagram – Simultaneous per PoC Client.....	9
6.2.7.1	State 'Start-stop'.....	9
6.2.7.1.1	Monitor Primary PoC Session establishment (M: Primary PoC Session established).....	9
6.2.7.1.2	Monitor Secondary PoC Session establishment (M: Secondary PoC Session established).....	9
6.2.7.2	State: 'C: Primary PoC Session Active'.....	9

6.2.7.2.A	General	9
6.2.7.2.1	Monitor Primary PoC Session release when no other PoC Sessions are ongoing (M: Last Primary PoC Session released)	9
6.2.7.2.2	Send SDP with Session LockIn (S: Session LockIn)	9
6.2.7.2.3	Monitor Secondary PoC Session release (M: Secondary PoC Session released)	9
6.2.7.2.4	Monitor Secondary PoC Session establishment (M: Secondary PoC Session established)	9
6.2.7.2.5	Monitor Primary PoC Session release (M: Primary PoC Session released)	9
6.2.7.2.6	Receive Media Burst Granted message (R: MB_Granted for Secondary PoC Session)	9
6.2.7.2.7	Receive RTP Media packets (R: Media from Secondary PoC Session)	9
6.2.7.2.8	Receive Talk Burst Granted message (R: TB_Granted for Secondary PoC Session)	9
6.2.7.3	<i>State: 'C: Secondary PoC Session Active'</i>	9
6.2.7.3.A	General	9
6.2.7.3.1	Monitor Secondary PoC Session release when no other PoC Sessions are ongoing (M: Last Secondary PoC Session released)	9
6.2.7.3.2	Send SDP with Session LockIn (S: Session LockIn)	9
6.2.7.3.3	Monitor Primary PoC Session establishment (M: Primary PoC Session established)	9
6.2.7.3.4	Receive RTP Media packets (R: Media from Primary PoC Session)	9
6.2.7.3.5	Monitor Secondary PoC Session release (M: Secondary PoC Session released)	9
6.2.7.3.6	Monitor Secondary PoC Session establishment (M: Secondary PoC Session established)	9
6.2.7.3.7	Receive RTP Media packets (R: Media from Secondary PoC Session)	9
6.2.7.4	<i>State: 'C: LockIn PoC Session Active'</i>	9
6.2.7.4.A	General	9
6.2.7.4.1	Monitor LockIn PoC Session release and no other PoC Session are ongoing (M: Last LockIn PoC Session released)	9
6.2.7.4.2	Monitor LockIn PoC Session release and Primary PoC Session ongoing (M: LockIn PoC Session released; Primary PoC Session ongoing)	9
6.2.7.4.3	Monitor LockIn PoC Session release and no Primary PoC Session ongoing (M: LockIn PoC Session released; no Primary PoC Session)	9
6.2.7.4.4	Monitor LockIn PoC Session is unlocked and Primary PoC Session ongoing (M: LockIn PoC Session unlocked; Primary PoC Session ongoing)	9
6.2.7.4.5	Monitor LockIn PoC Session is unlocked and no Primary PoC Session ongoing (M: LockIn PoC Session unlocked; no Primary PoC Session)	9
6.2.7.4.6	Receive MBCP Media Burst Granted message for Primary PoC Session (R: MB_Granted for Primary PoC Session)	9
6.2.7.4.7	Receive MBCP Media Burst Granted message for Secondary PoC Session (R: MB_Granted for Secondary PoC Session)	9
6.2.7.4.8	Receive TBCP Talk Burst Granted message for Primary PoC Session (R: TB_Granted for Primary PoC Session)	9
6.2.7.4.9	Receive TBCP Talk Burst Granted message for Secondary PoC Session (R: TB_Granted for Secondary PoC Session)	9
6.2.8	PoC Session control state diagram – Simultaneous PoC Sessions	9
6.2.8.1	<i>State 'Start-Stop'</i>	9
6.2.8.1.1	Monitor first PoC Session established (M: First PoC Session established)	9
6.2.8.1.2	Monitor another PoC Session established (M: Another PoC Session established)	9
6.2.8.2	<i>State: 'S: Active'</i>	9
6.2.8.2.1	Send or receive MBCP message (S/R: MBCP)	9
6.2.8.2.2	Send or receive RTP Media packets (S/R: Media)	9
6.2.8.2.3	Monitor PoC Session release when no other PoC Sessions are ongoing (M: Last PoC Session released)	9
6.2.8.2.4	Send SDP with Session LockIn; LockIn indication for the Active PoC Session (S: Session LockIn; Active PoC Session)	9
6.2.8.2.5	Send SDP with Session LockIn; LockIn indication for another PoC Session (S: Session LockIn; another PoC Session)	9
6.2.8.2.6	Send SDP with Session UnLock; switch to another PoC Session (S: Session Unlock; another PoC Session)	9
6.2.8.2.7	Send SDP with Session UnLock; remain active in the current PoC Session (S: Session Unlock; remain in PoC Session)	9
6.2.8.2.8	Monitor SDP with Primary PoC Session established or selected (M: Primary PoC Session established or selected)	9
6.2.8.2.9	Receive RTP Media packets (R: Media for another PoC Session)	9
6.2.8.2.10	Send or receive TBCP message (S/R: TBCP)	9
6.2.8.3	<i>State: 'S: Dormant'</i>	9
6.2.8.3.1	Send or receive MBCP message (S/R: MBCP)	9
6.2.8.3.2	Send SDP with Session LockIn for this PoC Session (S: Session LockIn; this PoC Session)	9
6.2.8.3.3	Send SDP with Session LockIn for another PoC Session (S: Session LockIn; another PoC Session)	9
6.2.8.3.4	Send SDP with Primary PoC Session selected; this PoC Session selected (S: Set Primary PoC Session; this PoC Session)	9

6.2.8.3.5	Send SDP with Primary PoC Session selected; another PoC Session selected or criteria not fulfilled (S: Set Primary PoC Session; another PoC Session or criteria not fulfilled).....	9
6.2.8.3.6	Send SDP with PoC Session UnLock and remain active in another PoC Session (S: Session UnLock; remain dormant) 9	9
6.2.8.3.7	Send SDP with PoC Session UnLock and switch to this PoC Session (S: Session UnLock; switch to this PoC Session) 9	9
6.2.8.3.8	Monitor PoC Session release and activate this PoC Session (M: PoC Session released; activate this PoC Session)....	9
6.2.8.3.9	Monitor PoC Session release and remain active in another PoC Session (M: PoC Session released; remain dormant) 9	9
6.2.8.3.10	Receive MBCP Media Burst Granted message (R: MB_Granted).....	9
6.2.8.3.11	Receive RTP Media packets (R: Media for this PoC Session)	9
6.2.8.3.12	Send or receive TBCP message (S/R: TBCP).....	9
6.2.8.3.13	Receive TBCP Talk Burst Granted message (R: TB_Granted).....	9
6.2.9	PoC Session control state diagram – queuing	9
6.2.9.1	State: 'Start-stop'	9
6.2.9.1.1	State: 'U: has no permission'.....	9
6.2.9.1.2	Send MBCP Media Burst Request message (S: MB_Request)	9
6.2.9.2	State: 'U: pending MB_request'	9
6.2.9.2.1	Receive MBCP Media Burst Granted message (R: MB_Granted).....	9
6.2.9.2.2	Receive MBCP Media Burst Taken message (R: MB_Taken).....	9
6.2.9.2.3	Receive MBCP Media Burst Deny message (R: MB_Deny)	9
6.2.9.2.4	T11 (Media Burst request) timer fired.....	9
6.2.9.2.5	T11 timer fired N times	9
6.2.9.2.6	Receive RTP Media packets (R: Media)	9
6.2.9.2.7	Receive MBCP Media Burst Request Queue Status message (R: MB_Queued)	9
6.2.9.2.8	Receiving a MSRP SEND request (R: MSRP SEND)	9
6.2.9.3	State: 'U: has permission'	9
6.2.9.3.1	Receive MBCP Media Burst Granted message (R: MB_Granted).....	9
6.2.9.4	State: 'U: pending MB_Release'.....	9
6.2.9.4.1	Receive MBCP Media Burst Granted message (R: MB_Granted).....	9
6.2.9.5	State: 'U: pending MB_Revoke'.....	9
6.2.9.6	State: 'U: Queued'.....	9
6.2.9.6.1	Receive RTP Media packets (R: Media)	9
6.2.9.6.2	Receive MBCP Media Burst Taken message (R: MB_Taken).....	9
6.2.9.6.3	Receive MBCP Media Burst Granted message (R: MB_Granted).....	9
6.2.9.6.4	Receive MBCP Media Burst Deny message (R: MB_Deny)	9
6.2.9.6.5	Send MBCP Media Burst Release message (S: MB_Release)	9
6.2.9.6.6	Receive MBCP Media Burst Request Queue Status message (R: MB_Queued)	9
6.2.9.6.7	Receive MBCP Media Burst Idle message (R: MB_Idle).....	9
6.2.9.7	State: Any state	9
6.2.9.7.1	Receive MBCP Disconnect message (R: Disconnect)	9
6.2.9.7.2	Receive PoC Session release - 1 (R: PoC Session release - 1)	9
6.2.9.8	State: Releasing	9
6.2.9.9	State: 'U: Permission to send limited segment'	9
6.2.10	PoC Client procedures for Media Stream not bound to Media-floor Control Entity	9
6.2.10.1	Receiving a MSRP SEND request	9
6.2.10.2	Sending a MSRP SEND request	9
6.3	PROCEDURES AT THE POC SERVER PERFORMING THE PARTICIPATING POC FUNCTION	9
6.3.1	General	9
6.3.2	Participating PoC Function procedures at PoC Session initialization.....	9
6.3.3	Participating PoC Function procedures at PoC Session release.....	9
6.3.3A	Participating PoC Function procedures at PoC Session modification.....	9
6.3.3A.1	Participating PoC Function procedures when connecting to a Media Type.....	9
6.3.3A.2	Participating PoC Function procedures when disconnecting from a Media Type	9
6.3.4	Participating PoC Function procedures at Pre-established Session release	9
6.3.5	PoC Session Procedures – basic.....	9
6.3.6	Pre-established Session state diagrams – basic	9
6.3.6.1	State 'Start-stop'	9
6.3.6.1.1	Pre-established Session started	9
6.3.6.2	State 'G: Pre-established Session_Not_in_use'.....	9
6.3.6.2.1	Receive SIP REFER request (R: SIP REFER)	9
6.3.6.2.2	Receive SIP INVITE request (R: SIP INVITE).....	9

6.3.6.2.3	Pre-established Session stopped.....	9
6.3.6.2.4	Receive SIP 200 "OK" response to the SIP re-INVITE request (R: 200 OK).....	9
6.3.6.3	State 'G: Pre-established Session_In_use'.....	9
6.3.6.3.1	Receive MBCP message (R: MBCP message).....	9
6.3.6.3.2	Receive RTP Media packets (R: RTP Media).....	9
6.3.6.3.3	Receive PoC Session release indication from PoC Client (R: PoC Session release from PoC Client).....	9
6.3.6.3.4	Receive PoC Session release indication from Controlling PoC Function (R: PoC Session release from PoC Server).....	9
6.3.6.3.5	Receive Pre-established Session stopped indication from PoC Client (R: Pre-established Session stopped from PoC Client).....	9
6.3.6.3.6	Receive MBCP Media Burst Acknowledgement message ((R: successful MB_Ack) and (R: failure MB_Ack)).....	9
6.3.6.3.7	T15 (Connect message re-transmit) timer fired.....	9
6.3.6.3.8	T15 (Connect message re-transmit) timer fired N times.....	9
6.3.6.3.9	Receive SIP 200 "OK" response (R: SIP 200 OK).....	9
6.3.6.3.10	Receives a failed SIP response from the Controlling PoC Function (R: PoC Session release from PoC Server).....	9
6.3.6.3.11	Receive MSRP request or response (R: MSRP request/response).....	9
6.3.6.3.12	Receive TBCP message (R: TBCP message).....	9
6.3.6.4	State 'G: PoC Session Releasing'.....	9
6.3.6.4.1	Receive MBCP Media Burst Acknowledgement message (R: MB_Ack).....	9
6.3.6.4.2	T16 (Disconnect message re-transmit) timer fired.....	9
6.3.6.4.3	T16 timer fired N times.....	9
6.3.7	Simultaneous PoC Sessions state diagram - per PoC Client.....	9
6.3.7.1	State 'Start-stop'.....	9
6.3.7.1.1	Monitor Primary PoC Session establishment (M: Primary PoC Session established).....	9
6.3.7.1.2	Monitor Secondary PoC Session establishment (M: Secondary PoC Session established).....	9
6.3.7.1.3	Monitor SDP LockIn PoC Session establishment (M: Session LockIn).....	9
6.3.7.2	State 'C: Primary PoC Session Active'.....	9
6.3.7.2.1	Monitor Primary PoC Session release when no other PoC Sessions are established (M: Last PoC Session released).....	9
6.3.7.2.2	Monitor SDP with PoC Session LockIn (M: Session LockIn).....	9
6.3.7.2.3	Monitor Secondary PoC Session release (M: Secondary PoC Session released).....	9
6.3.7.2.4	Monitor Secondary PoC Session establishment (M: Secondary PoC Session established).....	9
6.3.7.2.5	Monitor Primary PoC Session release (M: Primary PoC Session released).....	9
6.3.7.2.6	Monitor Media Burst message (M: MB_Granted for a Secondary PoC Session).....	9
6.3.7.2.7	T14 (Conversation) timer fired for Primary PoC Session.....	9
6.3.7.2.8	Monitor Primary PoC Session establishment (M: Primary PoC Session established).....	9
6.3.7.2.9	Monitor Talk Burst message (M: TB_Granted for a PoC Secondary PoC Session).....	9
6.3.7.2.10	Monitor Secondary PoC Session receiving RTP Media packets (R: Media from Secondary PoC Session).....	9
6.3.7.3	State: 'C: Secondary PoC Session Active'.....	9
6.3.7.3.1	Monitor Secondary PoC Session release when no other PoC Sessions are established (M: Last PoC Session released).....	9
6.3.7.3.2	Monitor SDP with PoC Session LockIn (M: Session LockIn).....	9
6.3.7.3.3	Monitor Primary PoC Session establishment (M: Primary PoC Session established).....	9
6.3.7.3.4	Receive RTP Media packets (R: Media from Primary PoC Session).....	9
6.3.7.3.5	Monitor Secondary PoC Session release (M: Secondary PoC Session released).....	9
6.3.7.3.6	Monitor Secondary PoC Session establishment (M: Secondary PoC Session established).....	9
6.3.7.3.7	Monitor T14 (Conversation) timer fired for Secondary PoC Session (M: T14 (Conversation) timer fired).....	9
6.3.7.3.8	Receive RTP Media packets (R: Media from Secondary PoC Session).....	9
6.3.7.3.9	Monitor MBCP Media Burst Granted message (M: MB_Granted).....	9
6.3.7.3.10	Monitor TBCP Talk Burst Granted message (M: TB_Granted).....	9
6.3.7.4	State: 'C: LockIn PoC Session Active'.....	9
6.3.7.4.1	Monitor LockIn PoC Session release and no other PoC Session ongoing (M: Last PoC Session released).....	9
6.3.7.4.2	Monitor LockIn PoC Session release and Primary PoC Session ongoing (M: [LockIn PoC Session released AND Primary PoC Session ongoing]).....	9
6.3.7.4.3	Monitor LockIn PoC Session release and no Primary PoC Session ongoing (M: [LockIn PoC Session released AND no Primary PoC Session ongoing]).....	9
6.3.7.4.4	Monitor LockIn PoC Session is unlocked and Primary PoC Session ongoing (M: [LockIn PoC Session unlocked AND Primary PoC Session ongoing]).....	9
6.3.7.4.5	Monitor LockIn PoC Session is unlocked and no Primary PoC Session ongoing (M: [LockIn PoC Session unlocked AND no Primary PoC Session ongoing]).....	9
6.3.7.4.6	Monitor Media Burst Granted message (M: Granted Primary PoC Session).....	9
6.3.7.4.7	Monitor Talk Burst Granted message (M: Granted Secondary PoC Session).....	9
6.3.7.4.8	Monitor SDP with PoC Session LockIn (M: Session LockIn).....	9
6.3.8	Simultaneous PoC Sessions state diagram - per PoC Session.....	9
6.3.8.1	State 'Start-Stop'.....	9

6.3.8.1.1	Initial PoC Session establishment (M: Initial PoC Session established)	9
6.3.8.1.2	Another PoC Session establishment (M: Another PoC Session established)	9
6.3.8.2	State 'S: Active'	9
6.3.8.2.1	Receive MBCP messages (R: MBCP Messages)	9
6.3.8.2.2	Receive RTP Media packets (R: Media)	9
6.3.8.2.3	Monitor PoC Session release when no other PoC Sessions are ongoing (M: Last PoC Session released)	9
6.3.8.2.4	Receive SDP with Session LockIn (R: Session LockIn)	9
6.3.8.2.5	Monitor SDP with Session UnLock (M: Session UnLock)	9
6.3.8.2.6	T14 (Conversation) timer fired	9
6.3.8.2.7	Monitor SDP with Primary PoC Session established or selected (M: [Primary PoC Session established OR Primary PoC Session selected])	9
6.3.8.3	State: 'S: Dormant'	9
6.3.8.3.1	Receive MBCP message (R: MBCP messages)	9
6.3.8.3.2	Receive RTP Media packets (R: Media)	9
6.3.8.3.3	Receive SDP with SIP Session LockIn (R: Session LockIn)	9
6.3.8.3.4	Receive SDP with Primary PoC Session selected (R: Set Primary PoC Session)	9
6.3.8.3.5	Receive SDP with SIP Session UnLock (R: Session UnLock)	9
6.3.8.3.6	Monitor PoC Session release (M: PoC Session released)	9
6.3.8.3.7	Monitor Media Burst Granted message (M: MB_Granted)	9
6.3.8.3.8	T14 (Conversation) timer fired	9
6.4	PROCEDURES AT THE PoC SERVER PERFORMING THE CONTROLLING PoC FUNCTION	9
6.4.1	General	9
6.4.2	Controlling PoC Function procedures at PoC Session initialization	9
6.4.3	Controlling PoC Function procedures at PoC Session release	9
6.4.3A	PoC Server procedures at PoC Session modification	9
6.4.3A.1	Controlling PoC Function procedures when adding a Media Type to a PoC Session	9
6.4.3A.2	Controlling PoC Function procedures when disconnecting from a Media Type	9
6.4.3A.3	Controlling PoC Function procedures when connecting to a Media Type	9
6.4.4	PoC Server state transition diagram for general Media Burst operation	9
6.4.4.1	State 'Start-stop'	9
6.4.4.1.1	PoC Session initialization	9
6.4.4.1.2	Media-floor Control Entity initiated	9
6.4.4.2	State 'G: MB_Idle'	9
6.4.4.2.1	Enter state 'G: MB_Idle'	9
6.4.4.2.2	Receive MBCP Media Burst Request message (R: MB_Request)	9
6.4.4.2.3	T7 (MB_Idle) timer fired	9
6.4.4.2.4	T4 (Inactivity) timer fired	9
6.4.4.2.5	Media Burst request queue not empty	9
6.4.4.3	State 'G: MB_Taken'	9
6.4.4.3.1	Enter the state 'G: MB_Taken'	9
6.4.4.3.2	T1 (End of RTP Media) timer fired	9
6.4.4.3.3	T2 (Stop talking) timer fired	9
6.4.4.3.4	Receive RTP Media packets (R: Media from permitted client)	9
6.4.4.3.5	Receive MBCP Media Burst Release message (R: MB_Release)	9
6.4.4.3.6	Receive MBCP Media Burst Request message with pre-emptive priority (R: MB_Request (pre-emptive))	9
6.4.4.3.7	Receive MBCP Media Burst Request message from permitted PoC Client (R: MB_Request)	9
6.4.4.3.8	Sending buffered Media packets (S: Buffered Media)	9
6.4.4.3.9	Congestion exists	9
6.4.4.3.10	Preload finished	9
6.4.4.3.11	T19 (start of MSRP) timer fires	9
6.4.4.3.12	MSRP SEND request received (R: MSRP SEND)	9
6.4.4.3.13	T18 (end of Media-floor time) timer fire	9
6.4.4.3.14	T20 (Granted re-send) timer fired	9
6.4.4.3.15	T20 (Granted re-send) timer fired N times	9
6.4.4.4	State 'G: pending MB_Release'	9
6.4.4.4.1	Enter the state 'G: pending MB_Release'	9
6.4.4.4.2	Receive last RTP Media packets (R: Last Media)	9
6.4.4.4.3	Receive RTP Media packets (R: Media)	9
6.4.4.4.4	T1 (End of RTP Media) timer fired	9
6.4.4.4.5	T2 (Stop talking) timer fired	9
6.4.4.4.6	Sending buffered Media packets (S: Buffered Media)	9
6.4.4.4.7	Receive last chunk in a MSRP SEND request (R: Last MSRP SEND)	9
6.4.4.4.8	MSRP SEND request (R: MSRP SEND)	9

6.4.4.4.9	T18 (end of Media-floor time) timer fired	9
6.4.4.5	State 'G: pending MB_Revoke'	9
6.4.4.5.1	Enter the 'G: pending MB_Revoke' state.....	9
6.4.4.5.2	Receive RTP Media packets (R: Media)	9
6.4.4.5.3	Receive MBCP Media Burst Release message (R: MB_Release (from permitted PoC Client)).....	9
6.4.4.5.4	Receive last RTP Media packets (R: Last Media)	9
6.4.4.5.5	T3 (Stop talking grace) timer fired	9
6.4.4.5.6	Sending buffered Media packets (S: Buffered Media)	9
6.4.4.5.7	MSRP SEND request received (R: MSRP SEND).....	9
6.4.4.6	State: Any state.....	9
6.4.4.6.1	Receive PoC Session release - 1 or the Media-floor Control is terminated.....	9
6.4.4.6.2	PoC Client joins an existing Media-floor Control Entity	9
6.4.4.6.3	PoC Client leaves an existing Media-floor Control Entity.....	9
6.4.4.7	State: 'Releasing'.....	9
6.4.4.7.1	Receive PoC Session release - 2	9
6.4.4.8	State: 'G: pending MB_Idle'.....	9
6.4.4.8.1	Enter the state 'G: pending MB_Idle'	9
6.4.4.8.2	Sending buffered Media packets (S: Buffered Media).....	9
6.4.4.8.3	The last RTP Media packet is sent (S: Last Media in buffer).....	9
6.4.5	PoC Server state transition diagram for basic Media Burst operation to the PoC Client	9
6.4.5.1	State 'Start-stop'.....	9
6.4.5.1.1	SIP Session initiated	9
6.4.5.1.2	Media-floor Control Entity initiated	9
6.4.5.2	State U: not permitted and MB_Idle.....	9
6.4.5.2.1	Enter the 'U: not permitted and MB_Idle' state.....	9
6.4.5.2.2	Permission state change.....	9
6.4.5.2.3	Receive MBCP Media Burst Request message (R: MB_Request).....	9
6.4.5.2.4	Receive MBCP Media Burst Release message (R: MB_Release).....	9
6.4.5.2.5	Receive RTP Media packets (R: Media)	9
6.4.5.2.6	Receive MSRP SEND request (R: MSRP SEND)	9
6.4.5.3	State U: not permitted and MB_Taken	9
6.4.5.3.1	Enter the 'U: not permitted and MB_Taken' state.....	9
6.4.5.3.2	Permission state change.....	9
6.4.5.3.3	Receive MBCP Media Burst Request message (R: MB_Request).....	9
6.4.5.3.4	Receive MBCP Media Burst Release message (R: MB_Release).....	9
6.4.5.3.5	Receive RTP Media packets (R: Media)	9
6.4.5.3.6	Receive MSRP SEND request (R: MSRP SEND)	9
6.4.5.4	State U: permitted	9
6.4.5.4.1	Enter the state 'U: permitted'	9
6.4.5.4.2	Receive MBCP Media Burst Release message (R: MB_Release).....	9
6.4.5.4.3	T1 (End of RTP Media) timer fired	9
6.4.5.4.4	T2 (Stop talking) timer fired	9
6.4.5.4.5	Receive RTP Media packets (R: Media)	9
6.4.5.4.6	Receive MBCP Media Burst Request message (R: MB_Request).....	9
6.4.5.4.7	T19 (start of MSRP) timer fired.....	9
6.4.5.4.8	T18 (end of Media-floor time) timer fired	9
6.4.5.4.9	Receive MSRP SEND request (R: MSRP SEND)	9
6.4.5.5	State 'U: pending MB_Revoke'.....	9
6.4.5.5.1	Enter the state 'U pending MB_Revoke'.....	9
6.4.5.5.2	T8 (Media Burst Revoke) timer fired	9
6.4.5.5.3	T3 (Stop talking grace) timer fired	9
6.4.5.5.4	Receive RTP Media packets (R: Media)	9
6.4.5.5.5	Receive MBCP Media Burst Release message (R: MB_Release).....	9
6.4.5.5.6	Receive last RTP Media packet (R: Last Media).....	9
6.4.5.5.7	T1 (End of RTP Media) timer fired	9
6.4.5.5.8	The timer T19 (start of MSRP) fired	9
6.4.5.5.9	Receive a MSRP SEND request (R: MSRP SEND).....	9
6.4.5.5.10	Receive last chunk in an MSRP SEND request (R: Last MSRP SEND).....	9
6.4.5.6	State 'U: waiting MB_Revoke'.....	9
6.4.5.6.1	Enter the 'U: waiting MB_Revoke' state	9
6.4.5.6.2	Receive Media Burst Request message (R: MB_Request)	9
6.4.5.6.3	T9 (Retry-after) timer fired	9
6.4.5.7	State U: not permitted but sends Media.....	9

6.4.5.7.1	Enter the 'U': not permitted but sends Media' state.....	9
6.4.5.7.2	T8 (Media Burst Revoke) timer fired	9
6.4.5.7.3	Receive MBCP Media Burst Release message (R: MB_Release).....	9
6.4.5.8	<i>State: Any state</i>	9
6.4.5.8.1	Receive PoC Session release – 1.....	9
6.4.5.9	<i>State: 'Releasing'</i>	9
6.4.5.9.1	Receive PoC Session release - 2	9
6.4.6	Controlling PoC Function procedures for Media Stream not bound to Media-floor Control Entity.....	9
6.4.6.1	<i>Receiving a MSRP SEND request</i>	9
6.5	MEDIA BURST CONTROL PROTOCOL (MBCP) MESSAGES.....	9
6.5.1	RTCP: APP message format.....	9
6.5.1.1	<i>General</i>	9
6.5.1.1.1	Handling of unknown fields and messages	9
6.5.1.2	<i>MBCP specific fields</i>	9
6.5.1.2.1	P-count.....	9
6.5.1.2.2	T2-timer	9
6.5.1.2.3	MB-priority-level	9
6.5.1.2.4	Time-stamp.....	9
6.5.1.2.5	Alert Margin	9
6.5.1.2.6	Privacy	9
6.5.1.2.7	Anonymous identity.....	9
6.5.1.2.8	MBCP-restrict	9
6.5.1.2.9	Media-Streams	9
6.5.1.2.10	Reason-Header	9
6.5.2	MBCP Media Burst Request message	9
6.5.3	MBCP Media Burst Granted message	9
6.5.4	MBCP Media Burst Deny message.....	9
6.5.4.1	<i>Reason codes</i>	9
6.5.4.1.1	Another PoC User has permission	9
6.5.4.1.2	Internal PoC Server Function error.....	9
6.5.4.1.3	Only one Participant	9
6.5.4.1.4	Retry-after timer has not expired	9
6.5.4.1.5	Receive only	9
6.5.4.1.6	No resources available.....	9
6.5.4.1.7	Other reason	9
6.5.5	MBCP Media Burst Release message.....	9
6.5.6	MBCP Media Burst Idle message	9
6.5.7	MBCP Media Burst Taken message	9
6.5.8	MBCP Media Burst Revoke message.....	9
6.5.8.1	<i>Reason codes</i>	9
6.5.8.1.1	Only one PoC User	9
6.5.8.1.2	Media Burst too long	9
6.5.8.1.3	No permission to send a Media Burst.....	9
6.5.8.1.4	Media Burst pre-empted	9
6.5.8.1.5	Media-floor occupied too long.....	9
6.5.8.1.6	No resources available.....	9
6.5.8.1.7	Other reason	9
6.5.9	MBCP Media Burst Acknowledgement message.....	9
6.5.9.1	<i>Reason codes</i>	9
6.5.9.1.1	Accepted	9
6.5.9.1.2	Busy	9
6.5.9.1.3	Not accepted	9
6.5.10	MBCP Media Burst Request Queue Status Request message	9
6.5.11	MBCP Media Burst Request Queue Status message	9
6.5.12	MBCP Disconnect message.....	9
6.5.13	MBCP Connect message.....	9
6.5.14	Subtype bit pattern reserved for future use	9
6.6	PROCEDURES AT THE UE POC BOX.....	9
6.6.1	UE PoC Box procedures at PoC Session initialization	9
6.6.2	UE PoC Box procedures at PoC Session release	9
6.6.3	UE PoC Box procedures at PoC Session modification.....	9

6.6.4	UE PoC Box control state diagram – Continuous Media.....	9
6.6.4.1	State 'Start-stop'.....	9
6.6.4.1.1	PoC Session established	9
6.6.4.2	State: 'B: has no permission'	9
6.6.4.2.1	Receive MBCP Media Burst Idle message (R: MB_Idle).....	9
6.6.4.2.2	Receive MBCP Media Burst Taken message (R: MB_Taken).....	9
6.6.4.2.3	Receive RTP Media packets (R: Media)	9
6.6.4.2.4	T13 (end of RTP Media) timer fired.....	9
6.6.4.2.5	Receive PoC Session release – 1 (R: PoC Session release - 1).....	9
6.6.4.2.6	Receiving a MSRP SEND request (R: MSRP SEND)	9
6.6.4.3	State: 'Releasing'.....	9
6.6.4.3.1	Receive PoC Session release – 2 (R: PoC Session release - 2).....	9
6.6.5	UE PoC Box procedures for Media Stream not bound to Media-floor Control Entity	9
6.6.5.1.1	Receiving a MSRP SEND request.....	9
6.7	PROCEDURES AT THE NW PoC BOX.....	9
6.7.1	NW PoC Box procedures at PoC Session initialization	9
6.7.2	NW PoC Box procedures at PoC Session release.....	9
6.7.3	NW PoC Box procedures at PoC Session modification.....	9
6.7.4	NW PoC Box control state diagram.....	9
6.7.4.1	State 'Start-stop'.....	9
6.7.4.1.1	PoC Session established	9
6.7.4.1.2	New Media-floor Control Entity initiated	9
6.7.4.2	State: 'N: has no permission'	9
6.7.4.2.1	Receive MBCP Media Burst Idle message (R: MB_Idle).....	9
6.7.4.2.2	Receive MBCP Media Burst Taken message (R: MB_Taken).....	9
6.7.4.2.3	Receive RTP Media packets (R: Media)	9
6.7.4.2.4	Send MBCP Media Burst Request message (S: MB_Request)	9
6.7.4.2.5	T13 (end of RTP Media) timer fired.....	9
6.7.4.2.6	Receiving a MSRP SEND request (R: MSRP SEND)	9
6.7.4.2.7	T12 (PoC Client retry-after) timer fired	9
6.7.4.3	State: 'N: pending MB request'.....	9
6.7.4.3.1	Receive MBCP Media Burst Granted message (R: MB_Granted).....	9
6.7.4.3.2	Receive MBCP Media Burst Taken message (R: MB_Taken).....	9
6.7.4.3.3	Receive MBCP Media Burst Deny message (R: MB_Deny)	9
6.7.4.3.4	T11 (Media Burst request) timer fired.....	9
6.7.4.3.5	T11 (Media Burst request) timer fired N times.....	9
6.7.4.3.6	Receive RTP Media packets (R: Media)	9
6.7.4.3.7	Send MBCP Media Burst Release message (S: MB_Release)	9
6.7.4.3.8	Receiving a MSRP SEND request (R: MSRP SEND)	9
6.7.4.4	State: 'N: has permission'	9
6.7.4.4.1	Send RTP Media packets (S: Media).....	9
6.7.4.4.2	Send MBCP Media Burst Release message (S: MB_Release)	9
6.7.4.4.3	Receive MBCP Media Burst Revoke message (R: MB_Revoke).....	9
6.7.4.5	State: 'N: pending MB Release'.....	9
6.7.4.5.1	T10 (Media Burst release) timer fired	9
6.7.4.5.2	T10 (Media Burst release) timer fired N times	9
6.7.4.5.3	Receive MBCP Media Burst Idle (R: MB_Idle).....	9
6.7.4.5.4	Receive MBCP Media Burst Taken message (R: MB_Taken).....	9
6.7.4.5.5	Receive RTP Media packets (R: Media)	9
6.7.4.5.6	Receive MBCP Media Burst Revoke message (R: MB_Revoke)	9
6.7.4.5.7	Receiving a MSRP SEND request (R: MSRP SEND)	9
6.7.4.6	State: 'N: pending MB_Revoke'.....	9
6.7.4.6.1	Send RTP Media (S: Media)	9
6.7.4.6.2	Receive MBCP Media Burst Idle message (R: MB_Idle).....	9
6.7.4.6.3	Receive MBCP Media Burst Taken message (R: MB_Taken).....	9
6.7.4.6.4	Receive RTP Media packets (R: Media)	9
6.7.4.6.5	Send MBCP Media Burst Release message (S: MB_Release)	9
6.7.4.6.6	Receiving a MSRP SEND request (R: MSRP SEND)	9
6.7.4.7	Any state.....	9
6.7.4.7.1	Receive PoC Session release – 1 (R: PoC Session release - 1).....	9
6.7.4.8	State: 'Releasing'.....	9
6.7.4.8.1	Receive PoC Session release – 2 (R: PoC Session release - 2).....	9
6.7.5	NW PoC Box procedures for Media Stream not bound to Media-floor Control Entity.....	9

6.7.5.1.1	Receiving a MSRP SEND request.....	9
7.	MEDIA CONTROL	9
7.1	QUALITY FEED BACK.....	9
7.1.1	General.....	9
7.1.2	Procedures at the PoC Client	9
7.1.2.1	PoC Client sending RTP Media packets.....	9
7.1.2.2	PoC Client receiving RTP Media packets.....	9
7.1.3	Procedures at the PoC Server performing the Participating PoC Function.....	9
7.1.4	Procedures at the PoC Server performing the Controlling PoC Function.....	9
7.1.5	Procedures at the PoC Box.....	9
7.1.5.1	Procedures at the NW PoC Box.....	9
7.1.5.2	Procedures at the UE PoC Box.....	9
7.2	MEDIA PARAMETER NEGOTIATION	9
7.3	USER PLANE ADAPTATION	9
7.3.1	Procedures at the PoC Client	9
7.3.2	Procedures at the PoC Server performing the Participating PoC Function.....	9
7.3.3	Procedures at the PoC Server performing the Controlling PoC Function.....	9
7.3.4	Procedures at the PoC Box.....	9
7.4	MEDIA ON AND OFF HOLD	9
7.4.1	Procedures at the PoC Client	9
7.4.2	Procedures at the PoC Server performing the Participating PoC Function.....	9
7.4.3	Procedures at the PoC Server performing the Controlling PoC Function.....	9
7.4.4	Procedures at the PoC Box.....	9
7.5	SIMULTANEOUS POC SESSIONS	9
7.5.1	Procedures at the PoC Client	9
7.5.2	Procedures at the PoC Server performing the Participating PoC Function.....	9
7.5.3	Procedures at the PoC Server performing the Controlling PoC Function.....	9
7.5.4	Procedures at the PoC Box.....	9
7.6	RTP SESSION RELEASE OF THE PRE-ESTABLISHED SESSION	9
7.7	MEDIA TRANSFER.....	9
7.7.1	Procedures at the PoC Client	9
7.7.2	Procedures at the PoC Server performing the Participating PoC Function.....	9
7.7.3	Procedures at the PoC Server performing the Controlling PoC Function.....	9
7.7.4	Procedures at the NW PoC Box.....	9
7.7.5	Procedures at the UE PoC Box	9
7.8	MEDIA BUFFERING	9
7.8.1	Procedures at the PoC Client	9
7.8.2	Procedures at the PoC Server performing the Participating PoC Function.....	9
7.8.3	Procedures at the PoC Server performing the Controlling PoC Function.....	9
7.8.4	Procedures at the PoC Box.....	9
7.9	CODECS	9
7.10	POC MEDIA TRAFFIC OPTIMISATION	9
7.11	MEDIA BURST CONTROL SCHEMES	9
7.12	DISCRETE MEDIA TRANSFER FINAL REPORT.....	9
7.12.1	General.....	9
7.12.2	Procedures at the originating PoC Client.....	9
7.12.3	Procedures at the PoC Server performing the Controlling PoC Function.....	9
7.12.4	Procedures at the PoC Server performing the Participating PoC Function.....	9
7.12.5	Procedures at the terminating PoC Client.....	9
7.12.6	Procedures at the terminating PoC Box	9
7.13	DISCRETE MEDIA TRANSFER PROGRESS REPORT.....	9
7.13.1	General.....	9
7.13.2	Procedures at the originating PoC Client.....	9
7.13.3	Procedures at the terminating PoC Client.....	9
7.13.4	Procedures at the terminating PoC Box	9
7.13.5	Procedures at the PoC Server performing the Controlling PoC Function.....	9
7.13.6	Procedures at the PoC Server performing the Participating PoC Function.....	9

8.	SENDER IDENTIFICATION	9
8.1	SENDER IDENTIFICATION INFORMATION IN THE PoC SERVER PERFORMING THE CONTROLLING PoC FUNCTION 9	
8.2	SENDER IDENTIFICATION INFORMATION IN THE PoC CLIENT	9
8.3	SENDER IDENTIFICATION INFORMATION IN THE PoC SERVER PERFORMING THE PARTICIPATING PoC FUNCTION.....	9
8.4	SENDER IDENTIFICATION IN THE PoC BOX	9
9.	TIMERS	9
9.1	TIMERS IN THE PoC SERVER PERFORMING THE CONTROLLING PoC FUNCTION	9
9.2	TIMERS IN THE PoC SERVER PERFORMING THE PARTICIPATING PoC FUNCTION.....	9
9.3	TIMERS IN THE PoC CLIENT	9
9.4	TIMERS IN THE PoC BOX.....	9
APPENDIX A.	CHANGE HISTORY (INFORMATIVE).....	9
A.1	APPROVED VERSION HISTORY	9
A.2	DRAFT/CANDIDATE VERSION 2.0 HISTORY	9
APPENDIX B.	STATIC CONFORMANCE REQUIREMENT (SCR) (NORMATIVE).....	9
B.1	PoC SESSION INITIATION, JOINING AND RELEASE (SJR)	9
B.1.1	PoC Client.....	9
B.1.2	PoC Server	9
B.2	MEDIA BURST CONTROL, NO QUEUING (MBN)	9
B.2.1	PoC Client.....	9
B.2.2	PoC Server	9
B.3	MULTIPLE SESSION SESSIONS (MUS)	9
B.3.1	PoC Client.....	9
B.3.2	PoC Server	9
B.4	PoC BOX (PBO).....	9
B.4.1	PoC Client.....	9
B.4.2	PoC Server	9
B.4.3	NW PoC Box	9
B.4.4	UE PoC Box.....	9
B.5	ADVANCED REVOCATION ALERT (ARA).....	9
B.5.1	PoC Client.....	9
B.5.2	PoC Server	9
B.6	MEDIA BURST CONTROL, QUEUING (MBQ)	9
B.6.1	PoC Client.....	9
B.6.2	PoC Server	9
B.7	TRAFFIC OPTIMISATION (TOP)	9
B.7.1	PoC Client.....	9
B.7.2	PoC Server	9
B.8	QUALITY OF EXPERIENCE (QOE).....	9
B.8.1	PoC Client.....	9
B.8.2	PoC Server	9
B.9	MEDIA BURST CONTROL SCHEME (MBC).....	9
B.9.1	PoC Client.....	9
B.9.2	PoC Server	9
B.10	POC SESSION-RELATED FEATURES (SRF)	9
B.10.1	PoC Client.....	9
B.10.2	PoC Server	9
B.11	QUALITY FEED BACK (QFB)	9
B.11.1	PoC Client.....	9
B.11.2	PoC Server	9
B.12	INVITED PARTIES IDENTITY INFORMATION (IPI).....	9
B.12.1	PoC Client.....	9
B.12.2	PoC Server	9
B.13	BACKWARDS COMPATIBILITY (XBC).....	9

B.13.1	PoC Client.....	9
B.13.2	PoC Server	9
APPENDIX C.	MESSAGE FLOWS (INFORMATIVE).....	9
C.1	MEDIA BURST REQUEST AT PoC SESSION INITIALIZATION	9
C.1.1	Message flows in the originating PoC network	9
C.1.1.1	Media Burst request procedure at PoC Session establishment – On-demand Session case.....	9
C.1.1.2	Media Burst request procedure at PoC Session establishment – Pre-established Session case	9
C.1.1.3	A PoC User joins a PoC Group during an ongoing Media Burst.....	9
C.1.1.4	PoC User releases PoC button before the PoC Session establishment is completed.....	9
C.1.1.5	PoC Session establishment failure – Pre-established Session case.....	9
C.1.1.6	PoC Session establishment– Limited Segment Media Buffer Preload Capability is used	9
C.1.2	Media Burst Granted message from PoC Server performing the Controlling PoC Function is lost	9
C.1.3	Message flows in the terminating PoC network.....	9
C.1.3.1	Inviting a PoC User to a PoC Session using On-demand Session establishment.....	9
C.1.3.2	Inviting a PoC User to a PoC Session using a Pre-established Session	9
C.2	MEDIA BURST IDLE PROCEDURE	9
C.3	MEDIA BURST REQUEST DURING A PoC SESSION.....	9
C.3.1	Sending a Media Burst request	9
C.3.2	Media Burst request when other PoC User has the permission to send a Media Burst and queuing is not supported9	
C.3.3	Another PoC User request the permission to send a Media Burst	9
C.3.4	Local Granted Mode	9
C.4	MEDIA BURST REVOKE PROCEDURE	9
C.4.1	User A receives notification that the Media Burst permission is revoked	9
C.5	MEDIA BURST RELEASE PROCEDURE	9
C.6	QUALITY FEEDBACK FLOWS	9
C.7	SENDER IDENTIFICATION FLOW	9
C.7.1	Without the Participating PoC Function in the Media path	9
C.7.2	When the Participating PoC Function in the Media path.....	9
C.8	POC SESSION RELEASE IN THE PRE-ESTABLISHED SESSION CASE	9
C.9	DISCRETE MEDIA FLOWS.....	9
C.9.1	Discrete Media message with Discrete Media Transfer Final Report.....	9
C.9.1.1	Originating flow	9
C.9.1.2	Terminating flow	9
C.10	DISCRETE MEDIA FLOWS.....	9
C.10.1	Discrete Media message with detailed Discrete Media Transfer Progress Report.....	9
C.10.1.1	Originating flow.....	9
C.10.1.2	Terminating flow.....	9
APPENDIX D.	RTP SESSION DESCRIPTION PARAMETERS (INFORMATIVE).....	9
APPENDIX E.	DOCUMENTATION OF XML EXTENSIONS	9
E.1	DISCRETE MEDIA TRANSFER FINAL REPORT.....	9
E.1.1	Structure of the Discrete Media Transfer Final Report.....	9
E.1.1.1	Example of Discrete Media Transfer Final Report.....	9
E.1.1.2	XML Schema for the Discrete Media Transfer Final Report	9
E.2	DISCRETE MEDIA TRANSFER PROGRESS REPORTS.....	9
E.2.1	Structure of the detailed Discrete Media Transfer Progress Report.....	9
E.2.2	Structure of optimized Discrete Media Transfer Progress Report	9
E.2.2.1	Example of detailed Discrete Media Transfer Progress Report	9
E.2.2.2	Example of optimized Discrete Media Transfer Progress Report	9
E.2.3	XML Schema for the Discrete Media Transfer Progress Report	9
E.2.3.1	XML Schema for detailed Discrete Media Transfer Progress Report.....	9
E.2.3.2	XML Schema for optimized Discrete Media Transfer Progress Report.....	9
APPENDIX F.	DOCUMENTATION OF MEDIA TYPES FOR IANA REGISTRATION	9
F.1	FINAL-REPORT.....	9
F.2	DISCRETE MEDIA TRANSFER PROGRESS REPORT.....	9
F.2.1	Detailed progress report.....	9
F.2.2	Optimized progress report.....	9

Figures

Figure 1: Entities in the User Plane.....9

Figure 2: Transport path options9

Figure 3: PoC Client state transition diagram for basic operation9

Figure 4: PoC Client state transition diagram for Pre-established Session.....9

Figure 5: Simultaneous PoC Sessions state diagram – per PoC Client.....9

Figure 6: PoC Session control state diagram – Simultaneous PoC Sessions9

Figure 7: PoC Session control state diagram – queuing.....9

Figure 8: Pre-established Session state diagrams – basic.....9

Figure 9: Simultaneous PoC Sessions state diagram - per PoC Client.....9

Figure 10: Simultaneous PoC Sessions state diagram - per PoC Session.....9

Figure 11: PoC Server state transition diagram for general Media Burst operation9

Figure 12: PoC Server state transition diagram for normal Media Burst operation to the PoC Client.....9

Figure 13: UE PoC Box control state diagram – Continuous Media9

Figure 14: NW PoC Box control state diagram9

Figure 15: Media Burst request procedure at PoC Session establishment – On-demand Session case9

Figure 16: Media Burst request procedure at PoC Session establishment – Pre-established Session case.....9

Figure 17: A PoC User joins a PoC Group during an ongoing Media Burst.....9

Figure 18: PoC User releases PoC button before the PoC Session establishment is completed.....9

Figure 19: PoC Session establishment is rejected – Pre-established Session case.....9

Figure 20: PoC Session establishment– Limited Segment Preload Capability is used9

Figure 21: MBCP Media Burst Granted message from PoC Server performing the Controlling PoC Function is lost ..9

Figure 22: Inviting a PoC User to a PoC Session using On-demand Session establishment9

Figure 23: Inviting a PoC User to a PoC Session using a Pre-established Session.....9

Figure 24: Media Burst idle procedure.....9

Figure 25: Sending a Media Burst request9

Figure 26: MBCP Media Burst Request message when other PoC User has the permission to send a Media Burst9

Figure 27: Another PoC User request the permission to send a Media Burst.....9

Figure 28: A PoC Client request permission to send Media using the Local Granted Mode9

Figure 29: Media Burst revoke procedure in PoC Server performing the Controlling PoC Function.....9

Figure 30: Media Burst release procedure9

Figure 31: RTCP SR compound packet from the PoC Client that transmitted the most recent Media Burst9

Figure 32: RTCP RR compound packet from the receiving PoC Client9

Figure 33: Identifying talking Participant in the PoC Client, without the Participating PoC Function in the Media path9

Figure 34: Identifying talking Participant in the PoC Client, with the Participating PoC Function in the Media path ..9

Figure 35: PoC Session release on the Pre-established Session case9

Figure 36: PoC Client A sends a Discrete Media message with Discrete Media Transfer Final Report9

Figure 37: PoC Client B receives a Discrete Media message9

Figure 38: PoC Client A sends a Discrete Media message with detailed Discrete Media Transfer Progress Report9

Tables

Table 1: RTCP: APP message format.....9

Table 2: MBCP specific fields.....9

Table 3: MBCP Media Burst Request message.....9

Table 4: MBCP Media Burst Granted message.....9

Table 5: MBCP Media Burst Deny message9

Table 6: MBCP Media Burst Release message.....9

Table 7: MBCP Media Burst Idle message.....9

Table 8: MBCP Media Burst Taken message9

Table 9: MBCP Media Burst Revoke message.....9

Table 10: MBCP Media Burst Acknowledgement.....9

Table 11: Media Burst Request Queue Status Request message.....9

Table 12: MBCP Media Burst Request Queue Status message.....9

Table 13: MBCP Disconnect message.....9

Table 14: MBCP Connect message9

Table 15: Media Burst Control timers.....9

Table 16: Simultaneous PoC Session timers.....9

Table 17: Media Burst Control timers.....9

Table 18: Media Burst Control timers.....9

1. Scope

This document describes the User Plane signalling procedures for the Push to talk over Cellular (PoC) service over the POC-3, POC-4, POC-10 and POC-12 reference points as defined in [OMA-PoC-AD] using the Media Burst Control Protocol (MBCP). This specification version is applicable, if the corresponding CP specification version is used as described in [OMA-PoC-CP] "*Backward compatibility*".

The Talk Burst Control Protocol (TBCP) can be used for PoC Speech and is specified in [OMA-PoC-1-UP].

When necessary, the interworking between the Control Plane [OMA-PoC-CP] and the User Plane is described in this document.

2. References

2.1 Normative references

- [3GPP2 S.R0100-0] 3GPP2 S.R0100-0 Push-to-Talk over Cellular (PoC) System Requirements, (v1.0).
URL: <http://www.3gpp2.org/>
- [OMA Dictionary] "Dictionary for OMA Specifications", Version 2.3, Open Mobile Alliance™,
OMA-ORG-Dictionary-V2_3,
URL: <http://www.openmobilealliance.org/>
- [OMA_SCR_Rules] "SCR Rules and Procedures", Version 1.0, Open Mobile Alliance™,
OMA-ORG-SCR_Rules_and_Procedures-V1_0,
URL: <http://www.openmobilealliance.org/>
- [OMA-IM-TS] "Instant Messaging using SIMPLE", Version 1.0, Open Mobile Alliance™,
OMA-TS-SIMPLE_IM-V1_0,
URL: <http://www.openmobilealliance.org/>
- [OMA-PoC-1-UP] "PoC User Plane", Version 1.0, Open Mobile Alliance™,
OMA-TS-PoC_UserPlane-V1_0-20060609-A,
URL: <http://www.openmobilealliance.org/>
- [OMA-PoC-AD] "Push to talk over Cellular (PoC) - Architecture", Version 2.0, Open Mobile Alliance™,
OMA-AD_PoC-V2_0,
URL: <http://www.openmobilealliance.org/>
- [OMA-PoC-CP] "OMA PoC Control Plane", Version 2.0, Open Mobile Alliance™,
OMA-TS-PoC_ControlPlane-V2_0,
URL: <http://www.openmobilealliance.org/>
- [OMA-PoC-DET-PROG-REP] "PoC - PoCV2.0 detailed Discrete Media Transfer Progress Report", Version 2.0, Open Mobile Alliance™,
OMA-SUP-XSD_poc_detProgressRep-V2_0,
URL: <http://www.openmobilealliance.org/>
- [OMA-PoC-Document-Mgmt] "OMA PoC Document Management", Version 2.0, Open Mobile Alliance™,
OMA-TS-PoC_Document_Management-V2_0,
URL: <http://www.openmobilealliance.org/>
- [OMA-PoC-FINAL-REP] "PoC - PoCV2.0 Discrete Media Transfer Final Report", Version 2.0, Open Mobile Alliance™,
OMA-SUP-XSD_poc_finalReport-V2_0,
URL: <http://www.openmobilealliance.org/>
- [OMA-PoC-IM] "OMA PoC Endorsement of OMA IM TS", Version 2.0, Open Mobile Alliance™,
OMA-TS-PoC_Endorsement_OMA_IM_TS-V2_0,
URL: <http://www.openmobilealliance.org/>
- [OMA-PoC-RD] "Push to talk over Cellular 2 Requirements", Version 2.0, Open Mobile Alliance™,
OMA-RD-PoC-V2_0,
URL: <http://www.openmobilealliance.org/>
- [RFC768] IETF RFC 768 (STD 0006): "User Datagram Protocol", August 1980,
URL: <http://www.ietf.org/rfc/rfc768.txt>
- [RFC1305] IETF RFC 1305: "Network Time Protocol (Version 3) Specification, Implementation and Analysis", March 1992.
URL: <http://www.ietf.org/rfc/rfc1305.txt>
- [RFC2119] IETF RFC 2119: "Key words for use in RFCs to Indicate Requirement Levels", S. Bradner,
March 1997, URL:<http://www.ietf.org/rfc/rfc2119.txt>
- [RFC2396] IETF RFC 2396: "Uniform Resource Identifiers (URI): Generic Syntax", August 1998,
URL:<http://www.ietf.org/rfc/rfc2396.txt>

- [RFC3261] IETF RFC 3261: "SIP: Session Initiation Protocol", June 2002,
URL: <http://www.ietf.org/rfc/rfc3261.txt>
- [RFC3267] IETF RFC 3267: "Real-Time Transport Protocol (RTP) Payload Format and File Storage Format for the Adaptive Multi-Rate (AMR) and Adaptive Multi-Rate Wideband (AMR-WB) Audio Codecs", June 2002,
URL: <http://www.ietf.org/rfc/rfc3267.txt>
- [RFC3323] IETF RFC 3323: "A Privacy Mechanism for the Session Initiation Protocol (SIP)",
URL: <http://www.ietf.org/rfc/rfc3323.txt>
- [RFC3489bis] IETF draft-ietf-behave-rfc3489bis (August 2007): "Session Traversal Utilities for (NAT) (STUN)", URL: <http://www.ietf.org/internet-drafts/draft-ietf-behave-rfc3489bis-13.txt>
- NOTE: The referenced IETF draft is a work in progress.
- [RFC3550] IETF RFC 3550: "RTP: A Transport Protocol for Real-Time Applications", July 2003,
URL: <http://www.ietf.org/rfc/rfc3550.txt>
- [RFC3558] IETF RFC 3558: "RTP Payload Format for Enhanced Variable Rate Codecs (EVRC) and Selectable Mode Vocoders (SMV)", June 2003,
URL: <http://www.ietf.org/rfc/rfc3558.txt>
- [RFC4566] IETF RFC 4566: "Session Description Protocol", July 2006,
URL: <http://www.ietf.org/rfc/rfc4566.txt>
- [RFC4975] IETF RFC 4975: "The Message Session Relay Protocol (MSRP)", September 2007,
URL: <http://www.ietf.org/rfc/rfc4975.txt>
- [TS26.235] 3GPP TS 26.235 "3rd Generation Partnership Project; Technical Specification Group Services and System Aspects; Packet switched conversational multimedia applications; Default codecs (Release 6)",
URL: http://www.3gpp.org/ftp/Specs/archive/26_series/26.235/
- [TS26.236] 3GPP TS 26.236 "3rd Generation Partnership Project; Technical Specification Group Services and System Aspects; Packet switched conversational multimedia applications; Transport protocols (Release 6)",
URL: http://www.3gpp.org/ftp/Specs/archive/26_series/26.236/

2.2 Informative references

- [3GPP2 C.S0047-0] 3GPP2 C.S0047-0 Link-Layer Assisted Service Options for Voice-over-IP: Header Removal (SO60) and Robust Header Compression (SO61), (v1.0).
URL: http://www.3gpp2.org/Public_html/specs/index.cfm#tsgc/
- [RFC2543] IETF RFC 2543: "SIP: Session Initiation Protocol", March 1999,
URL: <http://www.ietf.org/rfc/rfc2543.txt>

3. Terminology and conventions

3.1 Conventions

The key words "MUST", "MUST NOT", "REQUIRED", "SHALL", "SHALL NOT", "SHOULD", "SHOULD NOT", "RECOMMENDED", "MAY", and "OPTIONAL" in this document are to be interpreted as specified in [RFC2119].

All subclause, clauses and appendixes, except "Scope" and "Introduction", are normative, unless they are explicitly indicated to be informative.

3.2 Definitions

For the purposes of the PoC specifications, the terms and definitions given in [OMA Dictionary] and the following terms and definitions apply.

1-1 PoC Session	A feature enabling a PoC User to establish a PoC Session with another PoC User.
1-many-1 PoC Group Session	A PoC Session established by a PoC User to a Pre-arranged PoC Group, in which one Participant is a Distinguished Participant and other Participants are Ordinary Participants.
Active PoC Dispatcher	PoC User currently taking the role of PoC Dispatcher for all the Dispatch PoC Sessions of a Dispatch PoC Group. The Active PoC Dispatcher can change along time between PoC Users that are allowed the role of PoC Dispatcher for the Dispatch PoC Group (e.g. through role transfer mechanisms).
Active PoC Session	A PoC Session that carries both RTP and MBCP/TBCP based packets to the PoC User. If the PoC User has multiple PoC Sessions, at most only one can be active at any given time.
Ad-hoc PoC Group Session	A PoC Group Session established by a PoC User to PoC Users listed on the invitation. The list includes PoC Users or PoC Groups or both.
Advanced Revocation Alert	An alert to the PoC User that the Media transmit time will end within the time specified by the Alert Margin.
Alert Margin	The amount of time between the moment when the Advanced Revocation Alert is notified the PoC User and the moment when the granted Media Burst for the PoC User is to be revoked.
Anonymous PoC Address	A PoC Address identifies a PoC User who has requested privacy. The Anonymous PoC Address is of the form that the hostname of URI is "anonymous.invalid" and 'user' is of the form "anonymous-n". Anonymous PoC Addresses are scoped within a given PoC Session.
Answer Mode	A PoC Client mode of operation for the terminating PoC Session invitation handling.
Audio	General communication of sound with the exception of PoC Speech.
Automatic Answer Mode	Answer Mode where the PoC Client accepts a PoC Session establishment request without manual intervention from the PoC User. The Media is immediately played when received.
Chat PoC Group	A persistent PoC Group in which a PoC User individually joins to have a PoC Session with other joined PoC Users, i.e., the establishment of a PoC Session to a Chat PoC Group does not result in other PoC Users being invited. NOTE: A Chat PoC Group is a persistent PoC Group where the <invite-members> element is set to "false" as specified in the [OMA-PoC-Doc-Mgmt] " <i>PoC Group</i> ".
Chat PoC Group Session	A PoC Session established to a Chat PoC Group.
Confirmed Indication	A signalling message returned by the PoC Server to confirm that the PoC Server, all other network elements intermediary to the PoC Server and a terminating PoC Client are able and willing to receive Media.
Continuous Media	Media with an inherent notion of time (e.g., PoC Speech, Audio, and Video).
Control Plane	The specification of the signalling between PoC Client and PoC Server, between PoC Box and PoC Server and between PoC Servers for the Push to talk over Cellular (PoC) service.
Controlling PoC Function	A function implemented in a PoC Server, providing centralized PoC Session handling, which includes

	Media distribution, Talk Burst Control, Media Burst Control, policy enforcement for participation in the PoC Group Sessions, and the Participant information.
Conversation	A series of Media Bursts within a PoC Session in which the inter-arrival spacing of the Media Bursts is less than a defined time interval; typically, the Media Bursts are associated to a logical exchange between two or more PoC Users.
Discrete Media	Media that itself does not contain an element of time (e.g. images, text).
Discrete Media Transfer Final Report	A report sent to the sending PoC Client to indicate final status of the Discrete Media transfer to the receiving PoC Clients.
Discrete Media Transfer Progress Report	A report sent to the sending PoC Client to indicate progress of the Discrete Media transfer to the receiving PoC Clients.
Dispatch PoC Group	A Pre-arranged PoC Group in which one member is assigned the role of PoC Dispatcher and the other member(s) are assigned the role of PoC Fleet Members.
Dispatch PoC Session	The PoC Session of a Dispatch PoC Group, or a subset of the Dispatch PoC Group, in which the 1-many-1 communication method is used.
Distinguished Participant	A Participant in a 1-many-1 Session that sends Media to all Ordinary Participants and that receives Media from any Ordinary Participant. NOTE: The <is-key-participant> is set to "true" as specified in [OMA-PoC-Document-Mgmt] to indicate who is the Distinguished Participant.
Dormant PoC Session	A PoC Session in which the PoC User receives MBCP/TBCP messages and no RTP Media. If the PoC User has multiple PoC Sessions, all except at most one PoC Session are dormant.
Group	A predefined set of Users together with its policies and attributes. A Group is identified by a SIP URI.
Home PoC Network	A network comprising of a Home PoC Server and SIP/IP Core operated by the PoC User's PoC Service Provider. The Home PoC Network is the same as the Home Network defined in 3GPP/3GPP2 IMS specifications.
Home PoC Server	The PoC Server of the PoC Service Provider that provides PoC service to the PoC User.
Implicit Media Burst Request	A Media Burst request that is inferred from the receipt of a SIP INVITE request or a SIP REFER request as specified in [OMA-PoC-CP] " <i>Implicit Media Burst request</i> ".
Invited PoC Client	A PoC Client that is invited to a PoC Session.
Invited PoC User	The PoC User who has been invited to a PoC Session.
Inviting PoC Client	A PoC Client that invites other PoC User(s) to a PoC Session.
Inviting PoC User	The PoC User who invites other PoC User(s) to a PoC Session.
Local Granted Mode	A permission for a PoC User to start sending Media prior to receiving the MBCP Media Burst Grant message.
LockIn PoC Session	A PoC Session, which the PoC User is locked in when using Simultaneous PoC Sessions.
Media	Forms of information that are exchanged between Participants. Media may come in different forms, which are referred to as Media Types.
Media Burst	Flow of Media from a PoC Client that has the permission to send Media to the receiving PoC Client(s).
Media Burst Control	Media Burst Control is a control mechanism that arbitrates requests from the PoC Clients, for the right to send Media and Multimedia.
Media Burst Control Protocol	Media Burst Control Protocol (MBCP) is a protocol for performing Media Burst Control, and is defined in this document.
Media Parameters	Media Parameters are SIP/SDP based information exchanged between the PoC Server and the PoC Client, between the PoC Server and the PoC Box and between PoC Servers that specify the characteristics of the Media for a PoC Session being established or that already exists.
Media Stream	An instance of the transmission of a Media Type, which is used as the basic unit to distinguish each Media flow. Multiple Media Streams can be combined to transmit multimedia.

Media Type	Media Types share a characteristic of human perception. Media Types are either realtime or non-realtime, like: <ul style="list-style-type: none"> • PoC Speech • Audio (e.g. music) • Video • Discrete Media (e.g. still image, formatted and non-formatted text, file)
Media-floor Control Entity	A Media Control resource shared by Participants in a PoC Session. The Media-floor Control Entity is controlled by a state machine to ensure that only one Participant can access the Media resource at the same time. One Media-floor Control Entity can handle one or more Media Streams according to negotiation.
Nick Name	A user-friendly display name that might be associated to a PoC User or a PoC Group. The Nick Name can either be provided as a "display-name" in a SIP header or in the <display-name> child element of the <entry> element for the PoC User or for the PoC Group as specified in [OMA-PoC-Documents-Mgmt] or generated by PoC Server performing the Controlling PoC Function if unique Nick Names are supported and PoC User requested privacy.
NW PoC Box	A PoC functional entity in the PoC Network where PoC Session Data and PoC Session Control Data can be stored.
On-demand Session	A PoC Session set-up mechanism in which all Media Parameters are negotiated at PoC Session establishment.
Ordinary Participant	A Participant in a 1-many-1 PoC Group Session that is only able to send and receive Media to and from the Distinguished Participant.
Participant	A Participant is a PoC User in a PoC Session.
Participating PoC Function	A function implemented in a PoC Server, which provides PoC Session handling, which includes policy enforcement for incoming PoC Sessions and relays Talk Burst Control and Media Burst Control messages between the PoC Client and the PoC Server performing the Controlling PoC Function. The Participating PoC Function may also relay RTP Media between the PoC Client and the PoC Server performing the Controlling PoC Function.
PoC Address	An address identifying a PoC User. The PoC Address can be used by one PoC User to request communication with other PoC Users. If SIP/IP Core is the 3GPP/3GPP2 IMS the PoC Address is a public user identity.
PoC Box	A PoC functional entity where PoC Session Data and PoC Session Control Data can be stored. It can be a NW PoC Box or a UE PoC Box.
PoC Client	A functional entity that resides on the User Equipment that supports the PoC service.
PoC Dispatcher	The Participant in a Dispatch PoC Session that sends Media to all PoC Fleet Members and that receives Media from any PoC Fleet Member. <p style="margin-left: 40px;">NOTE: The PoC Dispatcher is an enhancement to the PoC 1 Distinguished Participant.</p>
PoC Fleet Member	A Participant in a Dispatch PoC Session that is only able to send Media to the PoC Dispatcher, and that likewise is only able to receive Media from the PoC Dispatcher. <p style="margin-left: 40px;">NOTE: PoC Fleet Member is the same as Ordinary Participant in PoC 1.</p>
PoC Group	A Group supporting the PoC service. PoC User uses PoC Groups e.g. to establish PoC Group Sessions.
PoC Group Identity	A SIP URI identifying a Pre-arranged PoC Group or a Chat PoC Group. A PoC Group Identity is used by the PoC Client e.g. to establish PoC Group Sessions to the Pre-arranged PoC Groups and Chat PoC Groups.
PoC Group Name	Indicates the name of the PoC Group that can be presented to the PoC User.
PoC Group Session	A Pre-arranged PoC Group Session, Ad-hoc PoC Group Session or Chat PoC Group Session.
PoC Media Traffic Optimisation	A mechanism for reducing PoC Media traffic via the PoC-4 reference point.
PoC Server	A network element, which implements the 3GPP/3GPP2 IMS application level network functionality for

	the PoC service. A PoC Server can perform the role of the Controlling PoC Function or Participating PoC Function, or both at the same time.
PoC Service Provider	A PoC Service Provider provides PoC Service – on its own or in conjunction with other Value Added Services – to his PoC Subscribers.
PoC Session	A PoC Session is a SIP Session established by the procedures of this specification. This specification supports the following types of PoC Sessions: 1-1 PoC Session, Ad-hoc PoC Group Session, Pre-arranged PoC Group Session, or Chat PoC Group Session.
PoC Session Identity	SIP URI, which identifies the PoC Session and which can be used for routing initial SIP requests. It is received by the PoC Client during the PoC Session establishment in the Contact header and/or in the MBCP Connect message in case of using Pre-established Session.
PoC Speech	Communication of speech as defined by PoC version 1.0.
PoC User	A User of the PoC service. A PoC User can be the same person as a PoC Subscriber. A PoC User uses the PoC features through the User Equipment.
Pre-arranged PoC Group	A persistent PoC Group. The establishment of a PoC Session to a Pre-arranged PoC Group results in the members being invited. NOTE: A Pre-arranged PoC Group is a persistent PoC Group, where the <invite-members> element is set to "true" as specified in the [OMA-PoC-Documents-Mgmt] "PoC Group".
Pre-established Session	The Pre-established Session is a SIP Session established between the PoC Client and the Home PoC Server containing at least one Media Stream bound to a Media-floor Control Entity. The PoC Client establishes the Pre-established Session prior to making requests for PoC Sessions to other PoC Users. To establish a PoC Session based on a SIP request from the PoC User, the PoC Server conferences other PoC Servers/Users to the Pre-established Session so as to create an end-to-end connection.
Primary PoC Session	A PoC Session that the PoC User selects in preference to other PoC Sessions. When the PoC User has Simultaneous PoC Sessions, the Primary PoC Session has a priority over Secondary PoC Sessions.
RTP Media	The Media carried in an RTP payload.
RTP Session	Considered as an association that allows exchange of RTP Media Streams and RTCP messages among a set of PoC functional entities.
Secondary PoC Session	A PoC Session for which the PoC User receives Media when there is no Media present on the Primary PoC Session.
Sender Identification	The procedure by which the identity of the current Media sender is determined and made known to receivers on the PoC Session.
Service Provider Policy	Service Provider Policy refers to the overall policy conditions actually selected by a service provider(s) for commercial implementation of a PoC service. Service Provider Policy is established based on commercial considerations, which may concern, e.g. support/non-support of certain network or client capabilities or service features within a network. Service Provider Policy is applicable only to the network or subscribers over which the service provider has control.
Simultaneous PoC Session	Functionality, where Home PoC Server discards Media for keeping conversation uninterrupted, in case a PoC User is a Participant in more than one PoC Session simultaneously using the same PoC Client.
SIP Session	A SIP dialog. From [RFC3261], a SIP dialog is defined as follows: A dialog is a peer-to-peer SIP relationship between two UAs that persists for some time. A dialog is established by SIP messages, such as a 2xx response to an INVITE request. A dialog is identified by a call identifier, local tag, and a remote tag. A dialog was formerly known as a call leg in [RFC2543].
SIP URI	From RFC 3261: "A SIP or SIPS URI identifies a communications resource" and "follows the guidelines in RFC 2396 [5]". PoC uses SIP URIs to identify PoC Clients, PoC Servers, and PoC Sessions, resource lists that point to URI lists, etc.
UE PoC Box	A functional entity co-located with the PoC Client in the User Equipment where PoC Session Data and PoC Session Control Data can be stored.
Unconfirmed Indication	An indication returned by the PoC Server to confirm that it is able to receive Media and believes the PoC Client is able to accept Media. The PoC Server sends the Unconfirmed Indication prior to determining that all elements on the forward path are ready or even able to receive Media.

User	Any entity that uses the described features through the User Equipment.
User Equipment	A hardware device that supports a PoC Client e.g., a wireless phone.
User Plane	The User Plane includes the Media and Media control signaling (e.g., Talk Burst Control Protocol) between the PoC Client and PoC Server, between the PoC Box and the PoC Server as well as between PoC Servers.
Video	Communication of live-streamed pictures without any Audio component.

3.3 Abbreviations

For the purposes of the PoC specifications, the abbreviations given in [OMA Dictionary] and the following abbreviations apply:

APP	Application defined RTCP packet
CNAME	Canonical name
GPS	Global Positioning System
ID	Identity
IETF	Internet Engineering Task Force
IP	Internet Protocol
MB_Ack	MBCP Media Burst Acknowledgement message
MB_Deny	MBCP Media Burst Deny message
MB_Granted	MBCP Media Burst Granted message
MB_Idle	MBCP Media Burst Idle message
MB_Queued	MBCP Media Burst Request Queue Status message
MB_Release	MBCP Media Burst Release message
MB_Request	MBCP Media Burst Request message
MB_Revoke	MBCP Media Burst Revoke message
MB_seg_Preload_in 200	Media Buffering Segment Preload in SIP 200 "OK"
MB_Taken	MBCP Media Burst Taken message
MBCP	Media Burst Control Protocol
MSRP	Message Session Relay Protocol

NOTE: The base Message Session Relay Protocol is defined in [RFC4975].

NAT	Network Address Translators
NAME	User Name SDES Item
NTP	Network Time Protocol
OMA	Open Mobile Alliance
PoC	Push to talk over Cellular
PT	Payload Type
QoE	Quality of Experience
RFC	Request For Comments (IETF specification)
RR	Receiver Report

RTCP	R TP Control Protocol
RTP	Real-time Transport Protocol
SCR	Static Conformance Requirement
SDES	Source Description RTCP Packet
SDP	Session Description Protocol
SIP	Session Initiation Protocol
SR	Sender Report
SSRC	Synchronization source
UDP	User Datagram Protocol

4. Introduction

4.1 Overview

This document describes the User Plane aspect of the PoC service. This document also gives an overview of the Discrete Media User Plane aspect of PoC service, details of which are defined in [OMA-IM-TS] and as endorsed in [OMA-PoC-IM]. The Control Plane is specified in [OMA-PoC-CP].

The PoC Service supports half-duplex type of communication for both Continuous Media and Discrete Media Types. Alternatively, PoC Clients in a PoC Session could select to send Discrete Media at any time. The PoC Client does not send a continuous stream of Media packets instead the Media is sent in bursts, in this document referred to as a Media Burst. A Talk Burst is the Media Burst, where the sent Media is PoC Speech. A Continuous Media Burst consists of one or more RTP Media packets and the Media Burst starts when the PoC Client sends the first RTP Media packet and it ends when the PoC Client sends the last RTP Media packet. The Discrete Media Burst consists of one or several messages delivered over MSRP as specified in [OMA-PoC-IM].

A PoC Server (referred to as the Controlling PoC Function in the [OMA-PoC-AD]) located between the PoC Clients communicating with each other acts as an arbitrator and controls the sending of Media Burst using a Media Burst Control Protocol (MBCP). In many of the PoC Service scenarios also a PoC Server (referred to as the Participating PoC Function in [OMA-PoC AD]) can be inserted in the Media path.

Before a PoC Client can send a Media Burst the PoC Client has to ask for permission from the PoC Server performing the Controlling PoC Function. Other PoC Clients in a PoC Session receive an indication about the identity of the PoC Client sending the Media Burst, subject to privacy.

For PoC Clients located on mobile devices the quality of the transmission can vary depending on access network and distance to the base station. This implies that the quality of sent Continuous Media Burst needs to be controlled using RTCP and, when needed, Media Parameters are changed for improving the PoC User's experience.

The State machines are used by the PoC Server, the PoC Client and the PoC Box to control each separate Media Floor Control Entity. Media Streams including one or more Media Types are bound to Media-floor Control Entities.

The state machines for the PoC Server are specified in subclause 6.3 "*Procedures at the PoC Server performing the Participating PoC Function*" and 6.4 "*Procedures at the PoC Server performing the Controlling PoC Function*".

The state machines for the PoC Client are specified in subclause 6.2 "*Procedures at the PoC Client*".

The state machines for PoC Box are specified in subclause 6.6 "*Procedures at the UE PoC Box*" and 6.7 "*Procedures at the NW PoC Box*".

4.2 User Plane routing

Figure 1 "*Entities in the User Plane*" shows the entities active in the User Plane in a PoC Session and the relevant User Plane interfaces in between.

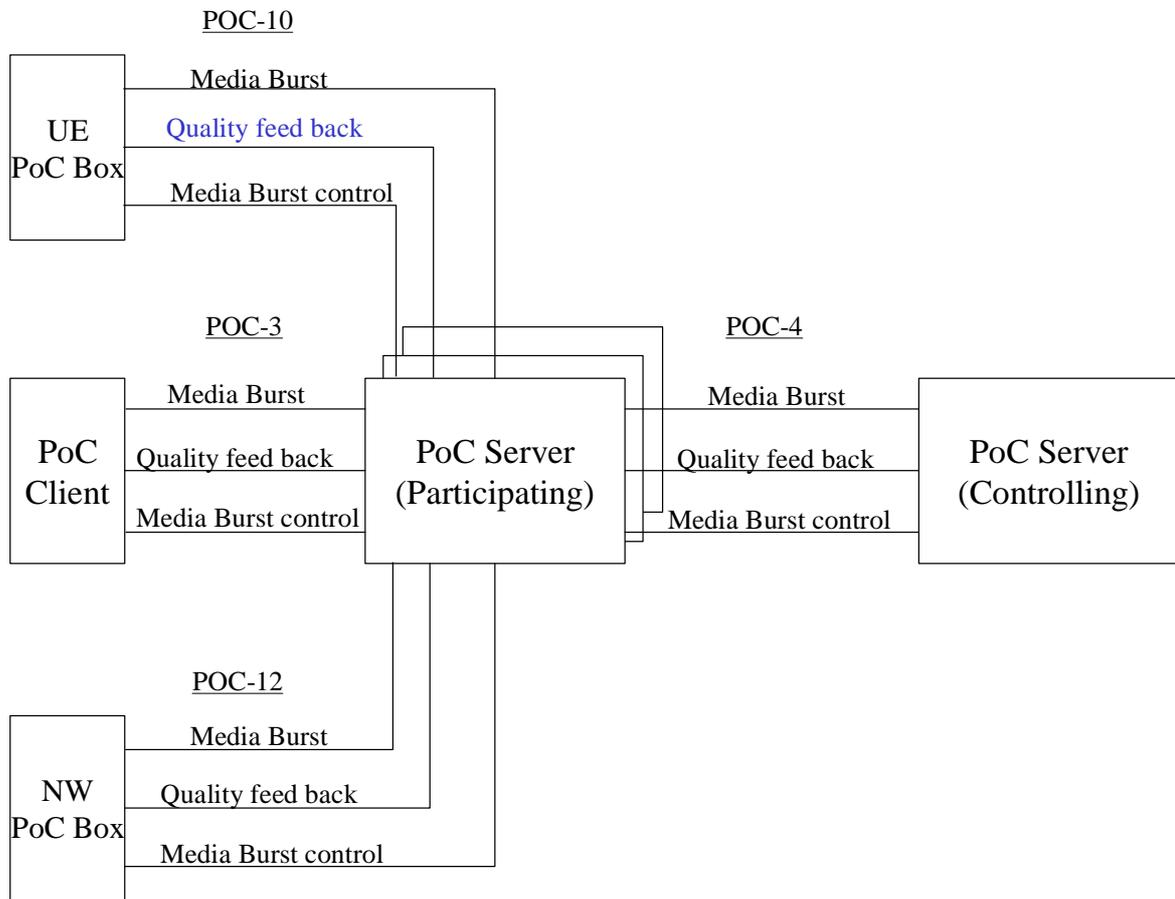

Figure 1: Entities in the User Plane

All RTP Media packets, MSRP messages, RTCP packets and MBCP messages flow through the PoC Server performing the Participating PoC Function (if inserted in the transport path) are terminated in the PoC Server performing the Controlling PoC Function.

Media Burst Control, MSRP message replication and RTP Media packet replication are done in Controlling PoC Functions.

The transport path between the PoC Client and the PoC Server performing the Controlling PoC Function is established on a per PoC Session basis as specified in [OMA-PoC-CP].

The transport path between the PoC Box (the NW PoC Box or the UE PoC Box) and the PoC Server performing the Controlling PoC Function is established on a per PoC Session basis as specified in [OMA-PoC-CP].

When the PoC Session is established, the PoC Server performing the Participating PoC Function normally includes itself into the transport path to relay the MSRP messages, RTP Media packets, RTCP packets and MBCP messages between the PoC Client or the PoC Box and the PoC Server performing the Controlling PoC Function and act as a RTP translator according to [RFC3550] and MSRP relay according to [OMA-PoC-IM].

Figure 2 "Transport Path Options" shows the 2 options for the transport path.

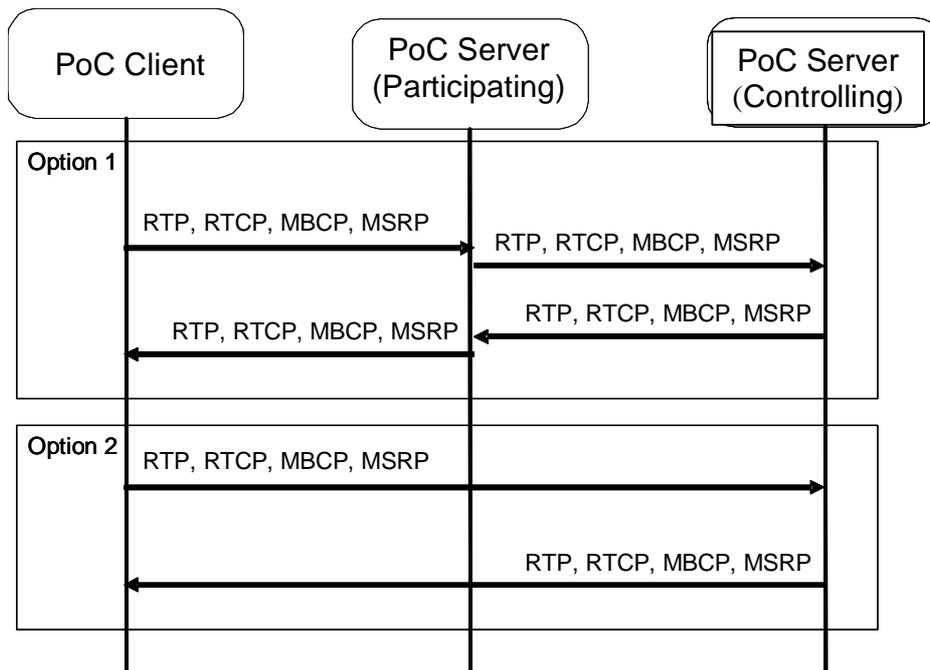

Figure 2: Transport path options

Option 1 is the case where a PoC Server performing the Participating PoC Function has inserted itself in the transport path. When included in the transport path the PoC Server performing the Participating PoC Function forwards MSRP messages, RTP Media packets, RTCP packets and MBCP messages between the PoC Client or the PoC Box and the PoC Server performing the Controlling PoC Function.

Examples of when the PoC Server performing the Participating PoC Function is in the transport path (Option 1) are:

- The PoC Session is over a Pre-established Session;
- The PoC Client and that PoC Server support Simultaneous PoC Sessions;
- The PoC Server needs transport information to support charging;
- The PoC Service Provider has configured the Participating PoC Function to be in the transport path;
- The PoC Server is used for transcoding or other Media translation;
- The PoC Server is used to support lawful intercept; and,
- The PoC Server is in the terminating PoC Network and the use of QoE Profiles is enabled.

In option 2, a PoC Server performing the Participating PoC Function has not inserted itself in the transport path. In this case the PoC Client or the PoC Box and the PoC Server performing the Controlling PoC Function send the MSRP messages, RTP Media packets, RTCP packets and MBCP messages directly between each other.

5. Transport

5.1 Internet Protocol

The IP domain for the PoC User Plane for a PoC Client, a PoC Box or a PoC Server SHALL be the same IP domain as the SIP/IP Core. (e.g., if the SIP/IP Core uses IPv4, the PoC Clients, the UE PoC Boxes, the NW PoC Boxes and PoC Servers in that network use IPv4 for the User Plane.)

NOTE: In case different domains have different IP versions, an IP protocol translator (e.g. NAT-PT) and an application level gateway (e.g. SIP-ALG) is needed, if PoC Servers do not support dual stack operation.

5.2 UDP

The User Datagram Protocol (UDP), as defined in [RFC768], SHALL be used as Continuous Media transport protocol over the POC-3, POC-4, POC-10 and POC-12 reference points.

5.2.1 Port Numbers

The UDP port numbers are used to identify the endpoints of the Continuous Media packets, MBCP messages and RTCP packets and SHALL be exchanged during the SIP Session establishment phase.

If the PoC Server performing the Participating PoC Function will be present in the Media path, the PoC Server performing the Participating PoC Function SHALL provide its port numbers for the Continuous Media and Media Burst Control Protocol part of the User Plane to the PoC Client or to the PoC Box and to the PoC Server performing the Controlling PoC Function during the SIP Session establishment phase.

If the PoC Server performing the Participating PoC Function will not be present in the Media path, the PoC Server performing the Participating PoC Function SHALL forward to the PoC Server performing the Controlling PoC Function the port numbers that it received from the PoC Client or from the PoC Box and return to the PoC Client or to the PoC Box the port numbers that it receives from the PoC Server performing the Controlling PoC Function.

The PoC Server SHALL use the same UDP port number for sending and receiving Continuous Media. The PoC Server SHALL use the same UDP port number for sending and receiving MBCP messages.

The PoC Client SHOULD use the same UDP port number for sending and receiving Continuous Media. The PoC Client SHOULD use the same UDP port number for sending and receiving MBCP messages.

The NW PoC Box SHOULD use the same UDP port number for sending and receiving MBCP messages.

The NW PoC Box SHOULD use the same UDP port number for sending and receiving Continuous Media.

NOTE 1: The UE PoC Box is only receiving Media hence no special requirements for selecting Continuous Media port applies.

NOTE 2: The sending port is not carried in SDP. This can allow a threat of masquerading the sending PoC Client to be imposed by other PoC Client that has the same IPv4 address, though the sending port number can be different. This is possible because the PoC Server cannot associate the SSRC with the Contact address of the PoC Client. Thus the PoC Client is recommended to use the same port for sending and receiving Media Streams. The same applies to the MBCP messages.

In case of Simultaneous PoC Sessions, the PoC Server performing the Participating PoC Function SHALL use a unique UDP port number for Media Streams per PoC Session towards the PoC Client. The PoC Server performing the Participating PoC Function SHALL use a unique UDP port number per Media-floor Control Entity for MBCP messages towards the PoC Client using Simultaneous PoC Sessions.

NOTE 3: Unique port numbers identify a Media-floor Control Entity and the Media-floor Control Entity identifies the PoC Session.

5.3 RTP

The Real-time Transport Protocol (RTP), as defined in [RFC3550], provides means for sending real-time data over UDP. In PoC, Media related to a Continuous Media over reference points POC-3, POC-4, POC-10 and POC-12 SHALL be transported by RTP/UDP/IP.

The Media SHALL be encapsulated in the RTP packets with Media specific RTP payload formats.

A PoC Client MAY send RTP Media packets without payload (referred to as "RTP "dummy" packets) in order to keep the Media path open through Network Address Translators (NAT).

NOTE 1: The PoC Server discards RTP Media packets without payload if received.

NOTE 2: How often the PoC Client needs to send the RTP Media packet without the payload is out of scope of this specification.

NOTE 3: The method how to determine if the PoC Client is behind a NAT or not is out of scope of this specification. However, one method for determine whether a PoC Client is behind a NAT or not is described in the [RFC3489bis]. Another method could be configuration of the PoC Client.

Before sending the first RTP Media packet, RTCP packet or Media Burst Control Protocol message in a PoC Session, the PoC Client, the PoC Server, the NW PoC Box or the UE PoC Box SHALL assign itself a SSRC identifier for the PoC Session. A suitable algorithm to generate the SSRC identifier is described in [RFC3550]. The allocated SSRC identifier SHALL NOT be 1111...1 (all 32 bits 1's), because this SSRC identifier is reserved for a special use.

5.4 RTCP

The PoC Client, the UE PoC Box, the NW PoC Box, the PoC Server performing the Controlling PoC Function and the PoC Server performing the Participating PoC Function SHALL support the RTP Control Protocol (RTCP), according to rules and procedures as specified in [RFC3550], with the clarifications in this subclause.

The MBCP messages SHALL be sent as RTCP APP packets.

When one Continuous Media is bound to a Media Floor Control Entity the MBCP messages SHOULD be sent to the same UDP port as the other RTCP packets.

When more than one Continuous Media is bound to a Media Floor Control Entity the MBCP messages SHOULD be sent to the one of the UDP port as the other RTCP packets for one of the Continuous Media bound to the Media Floor Control Entity.

NOTE 1: When only Discrete Media is bound to a Media-floor Control Entity a port independent on RTCP is selected for MBCP messages.

The PoC Client, the UE PoC Box, the NW PoC Box, the PoC Server performing the Controlling PoC Function and the PoC Server performing the Participating PoC Function:

- SHALL support the creation, modification and processing of the content in MBCP packets.

A PoC Client MAY send RTP Media packets without payload (referred to as "RTP "dummy" packets) to the port used for MBCP if MBCP uses a different UDP port than any of the ports used for RTCP for any of the Continuous Media or when MBCP is not using the RTCP port of any Continuous Media in order to keep the Media path open through Network Address Translators (NAT).

NOTE 2: The PoC Server discards RTP Media packets without payload if received.

NOTE 3: How often the PoC Client needs to send the RTP Media packet without the payload is out of scope of this specification.

NOTE 4: The method how to determine if the PoC Client is behind a NAT or not is out of scope of this specification. However, one method for determine whether a PoC Client is behind a NAT or not is described in the [RFC3489bis]. Another method could be configuration of the PoC Client.

RTCP packets, other than those used for MBCP messages, SHALL be RTCP compound packets according to rules and procedures as specified in [RFC3550]. MBCP messages SHOULD NOT be formatted as RTCP compound packets.

NOTE 5: Since the MBCP messages are not formatted as compound packets in compliance with [RFC3550], the Media Burst Control Protocol can be implemented separately from other standard RTCP message processing. By separating the MBCP messages, it is easier for the PoC Servers to forward these messages to the proper handling function.

The UE PoC Box, the NW PoC Box and the PoC Client,

- SHALL at the minimum support the reception of RTCP packets, in addition to those used for MBCP messages.

NOTE 6: If the PoC Client, the UE PoC Box, the NW PoC Box, supports the minimum level of RTCP, the PoC Client, the UE PoC Box or the NW PoC Box discards received RTCP packets.

- MAY support the creation and processing of the content in RTCP packets, in addition to those used for MBCP messages, to provide means for User Plane adaptation, feedback of the quality of the RTP Media packet transmission and give a persistent transport-level identifier for the RTP source.

The PoC Server performing the Controlling PoC Function and the PoC Server performing the Participating PoC Function:

- SHALL support the reception of RTCP packets, in addition to those used for MBCP messages.
- SHALL support forwarding of RTCP packets, in addition to those used for MBCP messages.
- MAY support creation, modification and processing of the content in RTCP packets, in addition to those used for MBCP messages, to provide means for User Plane adaptation and feedback of the quality of the RTP Media packet transmission.

NOTE 7: To reduce network load, it is beneficial if the RTCP compound packets created, modified or processed by the PoC Client, the PoC Box and the PoC Server only contains the mandatory RTCP packets required for that RTCP compound packet as specified in [RFC3550].

To reduce potential degradation of the quality of the RTP Media packet transmission, the PoC Client, the UE PoC Box, the NW PoC Box and the PoC Server SHOULD NOT schedule transmission of RTCP packets during a Media Burst as specified in 7.1 "Quality feed back".

The PoC Client, the UE PoC Box and the NW PoC Box SHOULD NOT send a RTCP BYE packet when leaving the PoC Session. The PoC Server performing the Controlling PoC Function and the PoC Server performing the Participating PoC Function SHOULD NOT send RTCP BYE packets when the PoC Session is released.

NOTE 8: The PoC service do not require control signalling in the RTP Session by RTCP to indicate which Participants that are leaving the PoC Session, and the PoC service entities do need to keep track of the number of Participants to calculate the transmission interval of RTCP. Therefore, the PoC Clients, the PoC Boxes and PoC Servers do not need to send RTCP BYE packets.

5.5 MSRP

The PoC Server performing the Controlling PoC Function SHALL support the Message Session Relay Protocol (MSRP) for the Discrete Media as specified in [OMA-IM-TS] and as endorsed in [OMA-PoC-IM].

The PoC Server performing the Participating PoC Function SHALL support the Message Session Relay Protocol (MSRP) for Discrete Media as specified in [OMA-IM-TS] and as endorsed in [OMA-PoC-IM].

The PoC Client, the UE PoC Box and the NW PoC Box MAY support the Message Session Relay Protocol (MSRP) for Discrete Media, according to rules and procedures as specified in [OMA-IM-TS] and as endorsed in [OMA-PoC-IM].

The MSRP message sending MAY be arbitrated by Media-floor Control Entity as specified in this document.

The PoC Server SHALL send Discrete Media Transfer Progress Report or Discrete Media Transfer Final Report or both if negotiated in [OMA-PoC-CP].

NOTE 1: If neither Discrete Media Transfer Progress Report nor Discrete Media Transfer Final Report is requested, the MSRP REPORT is sent and received according to rules and procedures of [OMA-PoC-IM].

NOTE 2: When the TCP connection is established the initiator of the TCP connection (the PoC Server or the PoC Client) sends an empty MSRP SEND request towards the remote side of the TCP connection as specified in [RFC4975] "*MSRP Connection Mode*" in order to bind the TCP connection to the MSRP session.

NOTE 3: The first received MSRP message is ignored by the receiver.

The PoC functional entities supporting MSRP SHALL establish the TCP connection used for the MSRP towards the IP address included in the SDP c= line and the TCP port included in the SDP m= line of the MSRP SDP media description as specified in the [RFC4566] in the SDP body negotiated in the [OMA-PoC-CP].

6. Media Burst Control

This subclause describes the Media Burst Control Protocol (MBCP).

NOTE 1: Some Media Burst Control Protocol procedures allow usage of Talk Burst Control Protocol messages, if the Talk Burst Control Protocol is negotiated instead of Media Burst Control Protocol.

NOTE 2: Other protocols for handling Media Burst Control can be used but they are not specified by this document.

6.1 General

Media Burst Control SHALL use the ports (in the PoC Client, PoC Box and PoC Servers) negotiated at the SIP Session establishment.

The PoC Client and the PoC Server SHALL support the following basic Media Burst Control Protocol messages:

- MBCP Media Burst Request – is used by the PoC Client to request permission from the PoC Server to send a Media Burst.
- MBCP Media Burst Granted – is used by the PoC Server to notify the PoC Client that it has been granted permission to send a Media Burst. The Controlling PoC Function includes information about the stop talking timer and can include the number of Participants connected to the Media-floor Control Entity at the time that this message is sent.
- MBCP Media Burst Deny – is used by the PoC Server to notify a PoC Client that it has been denied permission to send a Media Burst.
- MBCP Media Burst Release – is used by the PoC Client to notify the PoC Server that it has completed sending the Media Burst or it cancels the permission before sending Media Burst or it requests the PoC Server to cancel the queued Media Burst request when queuing is supported by the PoC Client and PoC Server.
- MBCP Media Burst Idle – is used by the PoC Server to notify all PoC Clients that no one has the permission to send a Media Burst at the moment and that the PoC Server can accept the MBCP Media Burst Request message.
- MBCP Media Burst Taken – is used by the PoC Server to notify all PoC Clients, except the PoC Client that has been given permission to send a Media Burst that another PoC Client has been given permission to send a Media Burst.

NOTE 1: In the case of privacy the real identity of the PoC User, with the permission to send a Media Burst, is replaced with an anonymous identity as specified in [OMA-PoC-CP] "*Anonymous PoC Address*".

- MBCP Media Burst Revoke – is used by the PoC Server to revoke the permission to send Media from a PoC Client and can be used for pre-emption functionality, but is also be used by the system to prevent overly long use of the Media-floor Control Entity.
- MBCP Media Burst Acknowledgement – is used by the PoC Client, when acknowledgement is required in the received MBCP message.

If the PoC Server and the PoC Client support Pre-established Sessions, the PoC Client and the PoC Server SHALL support the following additional MBCP Control message:

- MBCP Connect – is used by the PoC Server to notify the served PoC Client using a Pre-established Session, that a PoC Session is connected.
- MBCP Disconnect – is used by the PoC Server to close the PoC Session using a Pre-established Session while maintaining the Pre-established Session.

A PoC Server performing the Controlling PoC Function and supporting queuing of MBCP Media Burst Request messages, a PoC Client supporting queuing of the MBCP Media Burst Request message and a PoC Server performing the Participating PoC Function inserted in the Media path SHALL support the following additional Media Burst Control Protocol messages:

- MBCP Media Burst Request Queue Status – is used by the PoC Server to notify the PoC Client that the MBCP Media Burst Request has been queued.

NOTE 2: The PoC Server performing the Participating PoC Function normally only has to transparently transport the MBCP message unless the PoC Server supports Pre-established Session or Simultaneous PoC Sessions.

A Participating PoC Server SHALL send the MBCP Media Burst Acknowledgment message when a MBCP message requires an acknowledgment.

The Media Burst Control Protocol reliability SHALL be ensured thru timer-based retransmissions. Timers are defined in subclause 9.1 "*Timers in the PoC Server performing the Controlling PoC Function*", 9.2 "*Timers in the PoC Server performing the Participating PoC Function*", "*Timers in the PoC Client*" and 9.4 "*Timers in the PoC Box*".

6.2 Procedures at the PoC Client

6.2.1 PoC Client procedures at PoC Session initialization

When a PoC Session is established for a PoC Client, a new instance of the 'PoC Session control state machine – basic' is created or 'PoC Session control state machine – queuing' is created for each agreed Media-floor Control Entity.

This applies to all cases of PoC Session establishment, that is:

- PoC Sessions using On-demand Session signalling origination or termination, or,
- PoC Sessions using Pre-established Session where the PoC Client initiates the PoC Session by sending a SIP REFER request; or,
- PoC Sessions using Pre-established Session where the PoC Server performing the Participating PoC Function sends a MBCP Connect message.

The SIP INVITE request or the SIP REFER request sent by the PoC Client

- can be regarded an implicit MBCP Media Burst Request message if a 1-1 PoC Session or an Ad-hoc PoC Group Session or a Pre-Arranged PoC Group Session is initiated when only PoC Speech is bound to the Media-floor Control Entity and if 'imp_mb_req' is not negotiated; or,
- can be regarded as an implicit MBCP Media Burst Request message if the parameter 'imp_mb_req=1' is negotiated and accepted by the PoC Server as specified in [OMA-PoC-CP] "*Media Burst Control Protocol MIME registration*"; or,
- can not be regarded as an implicit MBCP Media Burst Request message if a Chat PoC Group Session is initiated or in case of a rejoin to an already on-going PoC Session and if 'imb_mb_req' is not negotiated.

Based on the negotiations during PoC Session establishment either the basic or the optional queuing state machine is started for each agreed Media-floor Control Entity.

The state machines are defined in subclauses 6.2.5 "*PoC Session control state diagram – basic*" and 6.2.9 "*PoC Session control state diagram – Queuing*".

If Simultaneous PoC Sessions are supported, multiple instances of the PoC Session control state machine can be executing at the same time. For the purposes of this specification, each state machine operates independently and both the basic and the optional queuing state machine can be executing simultaneously. When the second PoC Session is created, within each PoC Session control state machine, basic or queuing, a sub-state machine is created for the 'U: not permitted and MB_Taken' state. This state machine is specified in subclause 6.2.8 "*PoC Session control state diagram – Simultaneous PoC Sessions*".

The PoC Client can negotiate the use of prioritization of MBCP Media Burst Request messages for each agreed Media-floor Control Entity. In that case, the PoC Client can request permission to send Media at a priority level that is either the same as or lower than the highest priority that was permitted to the Participant in the PoC Session initialization for the Media-floor Control Entity. If a PoC Client is authorized for pre-emptive priority in the PoC Session initialization for the Media-floor Control Entity it is good practise to always request permission to send Media at a priority level that is lower than pre-emptive priority unless the Participant explicitly requests to pre-empt the current Media sender.

6.2.2 PoC Client procedures at Pre-established Session initialization

When Pre-established Session is created, the PoC Client creates an instance of the PoC Session control state machine –Pre-established Session, as defined in subclause 6.2.6 "*PoC Session control state diagram –Pre-established Session*". There is one instance of this state machine for each Pre-established Session. This does not cause an instance of a 'PoC Session control state machine – basic' or a 'PoC Session control state machine – queuing' to be created. The instance of the 'PoC Session control state machine – basic' or the 'PoC Session control state machine – queuing' will be created when a PoC Session is initiated.

6.2.3 PoC Client procedures at PoC Session release

PoC Session release (whether it is initiated by the PoC Client or PoC Server) is a two-stage procedure.

In the first stage, the PoC Client stops sending MBCP messages for each Media-floor Control Entity and sending or playing Media for each Media Type.

In the second stage, when the Control Plane has determined that the PoC Session has been released, the corresponding instance of the PoC Session control state machine for each Media-floor Control Entity is also terminated and the PoC Client releases all the resources needed by the used Media Types.

The User Plane can initiate the first stage, but the Control Plane always initiates the second stage.

If the PoC Session is established over a Pre-established Session, the normal case for PoC Session release is to receive a MBCP Disconnect message from the Participating PoC Function. When the MBCP Disconnect message is received, the PoC Session control state machine initiates the PoC Session release.

If Simultaneous PoC Sessions are supported, each instance of the 'PoC Session control state machine – basic' or the 'PoC Session control state machine – queuing' will be terminated independently based on the state of the associated PoC Session.

6.2.4 PoC Client procedures at Pre-established Session release

The User Plane resources for a Pre-established Session are released after the Control Plane has released the Pre-established Session. This means that any PoC Session over the Pre-established Session has been released before the Pre-established Session is released and so, there are no RTP Media packets or MBCP messages flowing at the time that the Pre-established Session is released. All that the PoC Client needs to do is to release any User Plane resources associated with the Pre-established Session.

6.2.4A PoC Client procedures at PoC Session modification

6.2.4A.1 PoC Client procedures when connecting to a Media Type

When a new Media-floor Control Entity is offered by PoC Client to the PoC Server, a new instance of the 'PoC Session control state machine – basic' or 'PoC Session control state machine – queuing' is created for the Media-floor Control Entity and started based on the negotiation result. The state machines are defined in subclauses 6.2.5 "*PoC Session control state diagram – basic*" and 6.2.9 "*PoC Session control state diagram – Queuing*".

When a Continuous Media is accepted by the PoC Server to the PoC Session, the 'PoC Session control state diagram – Simultaneous per PoC Client' is created and started, if not already started. The state machine is defined in subclauses 6.2.7 "*PoC Session control state diagram – Simultaneous per PoC Client*".

NOTE: When a Continuous Media is connected, the Simultaneous PoC Sessions state machine is created and started in a special case, when the PoC Client has e.g. two PoC Sessions: one having only Discrete Media and another one having PoC Speech and when PoC User adds PoC Speech to the first PoC Session.

When the new Media-floor Control Entity offered by PoC Client to the PoC Server is rejected, the corresponding instance of the PoC Client state machine for basic operation or the PoC Session control state machine for queuing.

If connecting to a Media Type is agreed, the PoC Client starts using the connected Media Type.

6.2.4A.2 PoC Client procedures when disconnecting from a Media Type

If removing a Media-floor Control Entity or changing the Media-floor Control Entity bindings or if disconnecting from an existing Media Type the PoC Client:

1. SHALL release the permission to send Media as specified in subclause 6.2.5.4.2 "*Send MBCP Media Burst Release message (S: MB_Release)*" if the PoC Client has the permission to send Media; and,
2. SHALL stop sending Media Burst Control messages associated with the Media-floor Control Entity.

NOTE 1: Received Media or Media Burst Control messages are handled as specified in 6.2.5 "*PoC Session control state diagram – basic*".

When disconnecting from an existing Media Type is agreed, the PoC Client SHALL release resources used by the disconnected Media Type.

When removing of an existing Media-floor Control Entity is agreed, the corresponding instance of the PoC Client state machine diagram for basic operation or the PoC Session control state machine for queuing SHALL be terminated.

When the Media-floor Control bindings are changed the PoC Client SHALL not send Media and Media Burst Control messages according to the old binding.

NOTE 2: The ports to send Media and MBCP messages to is negotiated in the [OMA-PoC-CP] "*Procedures in the PoC Client*".

6.2.5 PoC Session control state diagram – basic

NOTE 1: When the PoC Client negotiates the Talk Burst Control Protocol as specified in [OMA-PoC-1-UP] instead of the Media Burst Control Protocol, the PoC Client acts as specified in [OMA-PoC-1-UP].

The PoC Client SHALL support the state diagram and the state transitions specified in this subclause for PoC Speech.

The PoC Client SHALL support the state diagram and the state transitions specified in this subclause for other Media Types than PoC Speech if other Media Types are bound to a Media-floor Control Entity.

NOTE 2: In the case the PoC Client supports Discrete Media not bound to a Media-floor Control Entity the state diagram and the state transitions specified in this subclause are not used for Discrete Media.

NOTE 3: The sending or receiving of reports related to Discrete Media are described in subclauses 7.12 "*Discrete Media Transfer Final Report*" and 7.13 "*Discrete Media Transfer Progress Report*".

Figure 3 "*PoC Client state transition diagram for basic operation*" shows the state diagram.

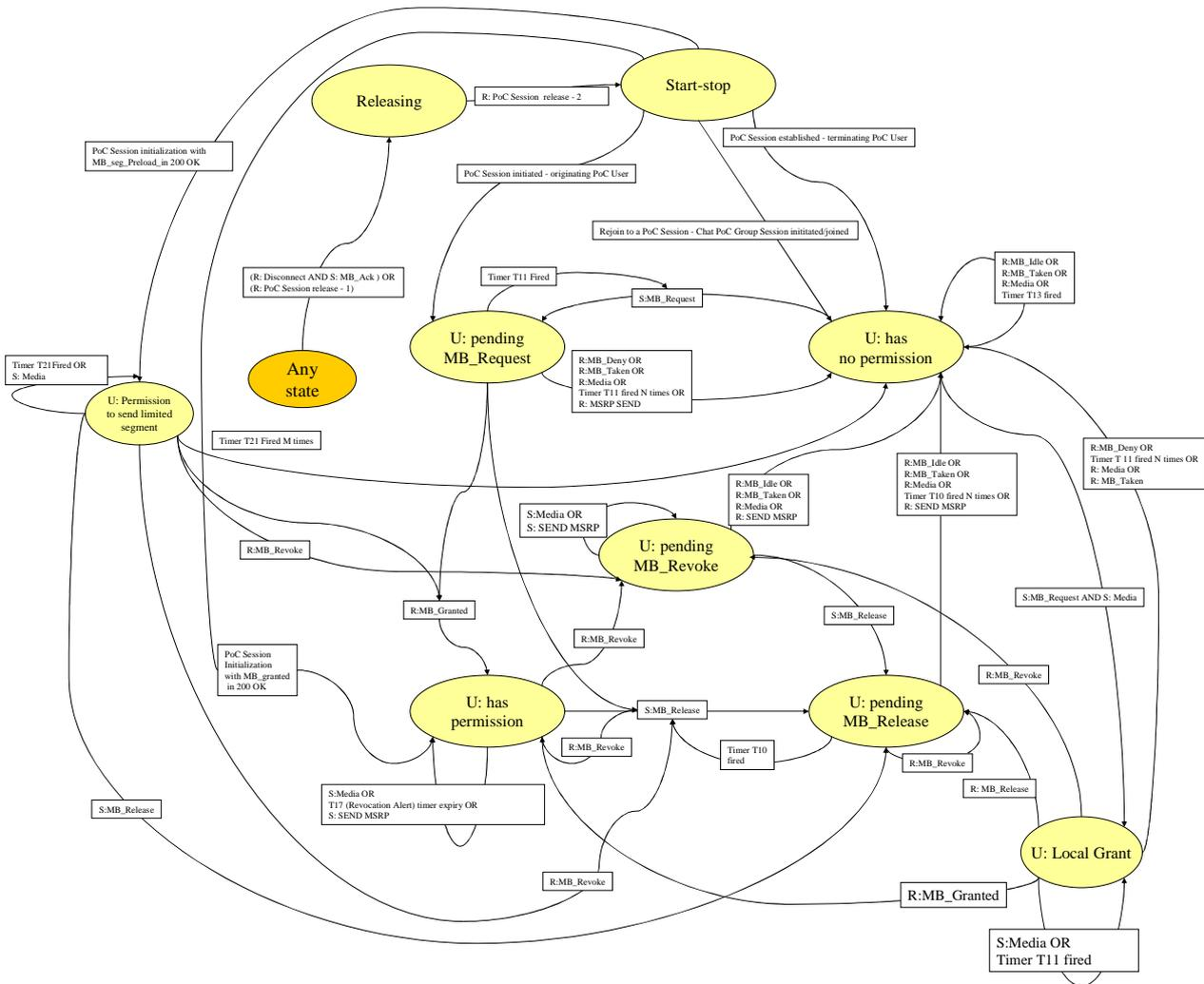

Figure 3: PoC Client state transition diagram for basic operation

State details are explained in the following subclauses.

If a MBCP message a MSRP message, a MSRP response or a RTP Media packet arrives in any state and there is no procedure specified in the subclauses below the PoC Client SHALL discard the MBCP message, the MSRP message, the MSRP response or the RTP Media packet and SHALL remain in the current state.

6.2.5.1 State 'Start-stop'

In this state no Media-floor Control Entity exists.

If the PoC Client supports Media buffering capability the PoC Client could already be buffering Media when the PoC Client enters this state.

6.2.5.1.1 PoC Session initiated – originating PoC User

When a PoC Session is initiated as described in [OMA-PoC-CP] "Using Pre-established Session" or in [OMA-PoC-CP] "Establishment of an On-demand Session" the originating PoC Client:

1. SHALL create an instance of the 'PoC Client state transition diagram for basic operation' state machine; and,

2. if the originating PoC Client receives a MBCP message before it receives the SIP 200 "OK" response, the PoC Client SHALL store the MBCP message.

NOTE: The originating PoC Client might receive a MBCP message before the SIP 200 "OK" response, because of processing delays of the SIP 200 "OK" in the SIP/IP Core. Regardless the order the PoC Client receives the SIP 200 "OK" response and the MBCP message, the PoC Client must wait for SIP 200 "OK" before moving out from the Start-Stop state.

3. If the value of the Session Type uri parameter received in the Contact header of the SIP 200 "OK" response is "chat" the PoC Client:
 - a. SHALL enter the 'U: has no permission state'.
4. If the value of the Session Type uri parameter received in the Contact header of SIP 200 "OK" response is different from "chat" the PoC Client,
 - a. for an On-demand Session if tb_granted parameter is either not received or received with the value 0 in the SIP 200 "OK" response as specified in [OMA-PoC-CP] "*Controlling PoC Function procedures*"; the PoC Client:
 - i. SHALL start timer T11 (Media Burst Request); and,
 - ii. in case that the PoC Client has received and stored a MBCP message before the reception of the SIP 200 "OK" response, the PoC Client SHALL act as if the MBCP message was received in the 'U: pending MB_Request' state, and not continue with the steps subsequent to this paragraph.
 - iii. SHALL enter the 'U: pending MB_Request' state.

or,

- b. for an On-demand Session if tb_granted parameter is received and set to 1 in the SIP 200 "OK" response as specified in [OMA-PoC-CP] "*Controlling PoC Function procedures*" the PoC Client:
 - i. SHALL enter the 'U: has permission' state.

or,

- c. for an On-demand Session if tb_seg_preload parameter is received and set to a non zero value in the SIP 200 "OK" response as specified in [OMA-PoC-CP] "*Controlling PoC Function procedures*" the PoC Client:
 - i. SHALL perform actions specified in subclause 6.2.5.9.1 "*Enter State U: Permission to send limited segment*".

or,

- d. for a Pre-established Session, when sending a SIP REFER request, the PoC Client:
 - i. SHALL enter the 'U: pending MB_Request' state.

When the PoC Client is rejoining an ongoing PoC Session as described in [OMA-PoC-CP] "*PoC Client rejoining a PoC Session*" the PoC Client:

1. SHALL enter the 'U: has no permission state'.

6.2.5.1.2 PoC Session established – terminating PoC User

When a PoC Session is established the terminating PoC Client:

1. SHALL create an instance of a PoC Client state transition diagram for basic operation state machine; and,
2. SHALL enter the 'U: has no permission' state.

NOTE: From a PoC Client perspective the PoC Session is established when the PoC Client sends the SIP 200 "OK" response or the MBCP Media Burst Acknowledgement message after reception of the MBCP Connect message.

6.2.5.1.3 Connecting to a Media-floor Control Entity during an ongoing PoC Session

When the PoC Client is connected to a Media-floor Control Entity during a PoC Session as specified in [OMA-PoC-CP] "*PoC Session Modification*" the PoC Client:

1. SHALL enter the 'U: has no permission' state.

6.2.5.2 State: 'U: has no permission'

The 'U: has no permission' state is a stable state and the PoC Client uses this state when the PoC Client is not sending Media or is not waiting for a MBCP message response.

In this state the PoC Client can receive RTP Media packets and MBCP Media Burst Control messages.

6.2.5.2.1 Receive MBCP Media Burst Idle message (R: MB_Idle)

Upon receiving MBCP Media Burst Idle message the PoC Client:

1. MAY provide Media Burst idle notification to the PoC User, if it has not done so;
2. SHALL stop the optional timer T13 (end of RTP Media), if it is running; and,
3. SHALL remain in the 'U: has no permission' state.

6.2.5.2.2 Receive MBCP Media Burst Taken message (R: MB_Taken)

Upon receiving of the MBCP Media Burst Taken message the PoC Client:

1. SHALL send a MBCP Media Burst Acknowledgement message if the MBCP Media Burst Taken message expects an acknowledgement reply;
2. SHOULD perform the mapping between the SSRC of the PoC Client granted a permission to send a Media Burst and the PoC Address or Nick Name or both, if they are included in the message;
3. SHALL provide a Media Burst taken notification to the PoC User;
4. MAY display the PoC Address and Nick Name to the PoC User, if they are included in the message;
5. SHOULD start the optional timer T13 (end of RTP Media) for the Active PoC Session if Continuous Media is bound to the Media-floor Control Entity; and,
6. SHALL remain in the 'U: has no permission' state.

6.2.5.2.3 Receive RTP Media packets (R: Media)

Upon receiving RTP Media packets the PoC Client:

1. SHALL render the Media;
2. MAY display the PoC Address or Nick Name or both based on SSRC of the sending PoC Client, if mapping between those exists in PoC Client;
3. SHOULD restart/start the optional timer T13 (end of RTP Media); and,
4. SHALL remain in the 'U: has no permission' state.

6.2.5.2.4 Send MBCP Media Burst Request message (S: MB_Request)

Upon receiving an indication from the PoC User to request permission to send Media and if timer T12 (Retry after) is not running and if removing a Media-floor Control Entity or changing the Media-floor Control Entity bindings or disconnecting from an existing Media Type is not initiated by the PoC Client the PoC Client:

1. SHALL send the MBCP Media Burst Request message toward the PoC Server;
2. SHALL stop the optional timer T13 (end of RTP Media), if it is running; and,
3. SHALL start timer T11 (Media Burst Request).
4. If Local Granted Mode is not used or not supported the PoC Client:
 - a. SHALL enter the 'U: pending MB_Request' state.
5. If Local Granted Mode is supported and used and if only PoC Speech is bound to the Media-floor Control Entity the PoC Client:
 - a. SHALL provide Media Burst granted notification to the PoC User;
 - b. MAY start sending RTP Media packets when receiving Media from the PoC User; and,
 - c. SHALL enter the 'U: Local Grant' state.

6.2.5.2.5 T13 (end of RTP Media) timer fired

On firing of T13 (end of RTP Media) timer, the PoC Client:

1. MAY provide Media Burst idle notification to the PoC User; and,
2. SHALL remain in the 'U: has no permission' state.

6.2.5.2.6 Receiving a MSRP SEND request (R: MSRP SEND)

Upon receiving an MSRP SEND request the PoC Client:

1. SHALL generate and send a MSRP 200 "OK" response according to rules and procedures of [OMA-PoC-IM];
2. MAY render the received content of the MSRP SEND request for the PoC User; and,
3. SHALL remain in the 'U: has no permission' state.

6.2.5.3 State: 'U: pending MB_Request'

The 'U: pending MB_Request' state is a transition state, and the PoC Client uses this state when the PoC Client is waiting for response to a MBCP Media Burst Request message.

In this state the PoC Client can receive RTP Media packets, the MSRP SEND messages and MBCP Media Burst Control messages.

Timer T11 (Media Burst Request) is running in this state.

If the PoC Client supports Media buffering capability the PoC Client can be buffering Media in this state.

This state is not used for Media buffering in the case that Limited Segment Media Buffering is used.

6.2.5.3.1 Receive MBCP Media Burst Granted message (R: MB_Granted)

Upon receiving a MBCP Media Burst Granted message from the PoC Server, the PoC Client:

1. SHALL provide Media Burst granted notification to the PoC User if not already done;

NOTE 1: Providing the Media Burst granted notification to the PoC User prior to receiving the MBCP Media Burst Granted message is an implementation option.

2. MAY provide information about the stop talking timer value to the PoC User;
3. MAY provide notification of the number of Participants connected to the Media-floor Control Entity, receiving the Media Burst in the PoC Session, to the PoC User, if included in the message;
4. SHALL stop timer T11 (Media Burst Request);
5. If MBCP Media Burst Granted message contains Alert-Margin parameter the PoC Client
 - a. MAY set the initial value of timer T17 (Revocation Alert) by calculating T2-timer minus Alert-Margin and start the timer T17 (Revocation Alert); and,
 - b. MAY start to display the T17 (Revocation Alert) timer, when the value of Alert Margin is zero;

NOTE 2: Advanced Revocation Alert is not valid when only Discrete Media is bound to the Media-floor.

6. SHALL enter the 'U: has permission' state.

6.2.5.3.2 Receive MBCP Media Burst Taken message (R: MB_Taken)

Upon receiving a MBCP Media Burst Taken message from the PoC Server, the PoC Client:

1. SHALL send a MBCP Media Burst Acknowledgement message if the MBCP Media Burst Taken message expects an acknowledgement reply;
2. SHOULD perform the mapping between the SSRC of the PoC Client granted a permission to send a Media Burst and the PoC Address or Nick Name or both, if they are included in the message;
3. SHALL provide a Media Burst taken notification to the PoC User;
4. MAY display the PoC Address and Nick Name to the PoC User, if they are included in the message;
5. SHALL stop timer T11 (Media Burst Request);
6. SHOULD start the optional timer T13 (end of RTP Media) if Continuous Media is bound to the Media-floor Control Entity; and,
7. SHALL enter the 'U: has no permission' state.

6.2.5.3.3 Receive MBCP Media Burst Deny message (R: MB_Deny)

Upon receiving a MBCP Media Burst Deny message from the PoC Server, the PoC Client:

1. SHALL provide Media Burst deny notification to the PoC User;
2. MAY display the Media Burst deny reason to the PoC User, if it is included in the message;
3. SHALL stop timer T11 (Media Burst Request); and,
4. SHALL enter the 'U: has no permission' state.

6.2.5.3.4 T11 (Media Burst request) timer fired

On firing of timer T11 (Media Burst Request), the PoC Client:

1. SHALL send a MBCP Media Burst Request message towards the PoC Server;
2. SHALL restart timer T11 (Media Burst Request); and,

3. SHALL remain in the 'U: pending MB_Request' state.

6.2.5.3.5 T11 (Media Burst request) timer fired N times

On the N:th firing of timer T11 (Media Burst Request), the PoC Client:

1. MAY provide a Media Burst request timeout notification to the PoC User; and,
2. SHALL enter the 'U: has no permission' state.

6.2.5.3.6 Receive RTP Media packets (R: Media)

Upon receiving RTP Media packets the PoC Client:

1. SHALL render the Media;
2. MAY display the PoC Address or Nick Name or both based on SSRC of the sending PoC Client, if mapping between those exists in PoC Client;
3. SHALL stop timer T11 (Media Burst Request);
4. SHOULD start the optional timer T13 (end of RTP Media); and,
5. SHALL enter the 'U: has no permission' state.

6.2.5.3.7 Send MBCP Media Burst Release message (S: MB_Release)

Upon receiving an indication from the PoC User to release permission to send Media, the PoC Client:

1. SHALL send a MBCP Media Burst Release message towards the PoC Server.
The MBCP Media Burst Release message:
 - a. SHALL set the sequence number ignore field to 1, because no RTP Media packets were sent.
2. SHALL start timer T10 (Media Burst Release);
3. SHALL stop timer T11 (Media Burst Request); and,
4. SHALL enter the 'U: pending MB_Release' state.

6.2.5.3.8 Receiving a MSRP SEND request (R: MSRP SEND)

Upon receiving MSRP SEND request the PoC Client:

1. SHALL generate and send a MSRP 200 "OK" response according to rules and procedures of [OMA-PoC-IM];
2. MAY render the received content of the MSRP SEND request to the PoC User;
3. SHALL stop timer T11 (Media Burst Request); and,
4. SHALL enter the 'U: has no permission' state.

6.2.5.4 State: 'U: has permission'

The 'U: has permission' state is a stable state and the PoC Client uses this state when the PoC Client is permitted to send Media. In this state the PoC Client is allowed to send RTP Media packets or MSRP SEND requests or both and can receive MBCP Media Burst Control messages.

In this state, the PoC Client can release permission to send a Media Burst anytime, even before sending any Media.

The PoC Client can have already buffered Media when it enters this state.

If the PoC Client entered this state from the 'U: Permission to send limited segment' state the PoC Client can have already transmitted some RTP Media packets for this Media Burst.

6.2.5.4.1 Send RTP Media packets (S: Media)

Upon receiving encoded voice from the PoC User or if encoded voice is already buffered, the PoC Client:

1. SHALL create and send an RTP Media packet toward the PoC Server.

The RTP Media packet SHALL include:

- a. The SSRC of the PoC Client; and,
- b. Other Media packets and payload attributes as defined in [RFC3550].

2. SHALL remain in the 'U: has permission' state.

6.2.5.4.2 Send MBCP Media Burst Release message (S: MB_Release)

Upon receiving an indication from the PoC User to release permission to send Media, the PoC Client:

1. SHALL send a MBCP Media Burst Release message towards the PoC Server.

The MBCP Media Burst Release message:

- a. SHOULD include the sequence number of the last RTP Media packet that was sent, if at least 1 RTP Media packet was sent and Continuous Media is bound to the Media-floor Control Entity; and,

NOTE: The PoC Client is expected to provide the sequence number in all cases when the PoC Client knows the sequence number of the RTP Media packets in the case Continuous Media is bound to the Media-floor Control Entity.

- b. SHALL set the sequence number ignore field to 1, if no Media were sent or if the PoC Client is not capable of providing the correct sequence number or if only Continuous Media is bound to the Media-floor Control Entity.
2. SHALL stop timer T17 (Revocation Alert), if timer T17 is running;
3. SHALL start timer T10 (Media Burst Release); and,
4. SHALL enter the 'U: pending MB_Release' state.

6.2.5.4.3 Receive MBCP Media Burst Revoke message (R: MB_Revoke)

Upon receiving a MBCP Media Burst Revoke message from the PoC Server, the PoC Client:

1. SHALL inform the PoC User that the permission to send a Media Burst is being revoked;
2. MAY give information to the PoC User about the reason for revoking the permission to send a Media Burst received in the reason code field;
3. MAY inform the PoC User of the retry after time, if a retry after time is contained in the MBCP Media Burst Revoke message;
4. SHALL stop receiving and encoding PoC User's Media;

NOTE 1: Media can be buffered in transport layer, in which case it's sending can be impossible to stop.

NOTE 2: MSRP chunk can be aborted according to rules and procedures of [RFC4975], if chunk is being sent.

5. SHALL stop timer T17 (Revocation Alert), if timer T17 is running;

6. SHOULD start the optional timer T12 (PoC Client retry-after), if a retry after time is contained in the MBCP Media Burst Revoke message;

NOTE 3: The PoC Client does not take any action when T12 expires, but when T12 is running, the PoC Client does not send a MBCP Media Burst Request message.

7. If the reason code is 'Media Burst too long' or 'Media-floor occupied too long' 'Other reason', or 'Media Burst pre-empted', the PoC Client SHALL enter the 'U: pending MB_Revoke' state; and,
8. If the reason code is 'Only one PoC User', 'No resources available' or 'No permission to send a Media Burst', the PoC Client:
 - a. SHOULD discard any remaining buffered RTP Media packets or MSRP SEND requests; and,
 - b. SHOULD perform the action in subclause 6.2.5.6.5 "*Send MBCP Media Burst Release message*".

6.2.5.4.4 T17 (Revocation Alert) timer expiry

Upon expiry of the timer T17 (Revocation Alert) in case the value of Alert Margin is non-zero, the PoC Client:

1. MAY alert the PoC User that the maximum-transmit time is almost reached.

NOTE: Upon firing of the T17 (Revocation Alert) timer in case the value of Alert Margin is zero, the PoC Client can send a MBCP Media Burst Release message towards the PoC Server as specified in subclause 6.2.5.4.2 "*Send MBCP Media Burst Release message (S: MB_Release)*".

6.2.5.4.5 Sending a MSRP SEND request (S: MSRP SEND)

When the state is permitted and Discrete Media is available for transfer, the PoC Client:

1. SHALL generate and send a MSRP SEND request according to rules and procedures of [OMA-PoC-IM];
2. SHALL include the encoded Discrete Media as specified in [OMA-PoC-IM];
3. SHALL send the MSRP SEND request according to rules and procedures of [OMA-PoC-IM]; and,
4. SHALL remain in the 'U: has permission' state.

6.2.5.5 State: 'U: pending MB_Release'

The 'U: pending MB_Release' state is a transition state and the PoC Client uses this state when the PoC Client is waiting for response to a MBCP Media Burst Release message.

In this state the PoC Client can receive MBCP Media Burst Control messages, MSRP SEND requests and RTP Media packets.

Timer T10 (Media Burst release) is running and the optional timer T12 (PoC Client retry-after) can be running in this state.

6.2.5.5.1 T10 (Media Burst release) timer fired

On firing of timer T10 (Media Burst Release), the PoC Client:

1. SHALL send a MBCP Media Burst Release message towards the PoC Server.

The MBCP Media Burst Release message:

- a. SHALL include the SSRC of the PoC Client;
- b. SHALL include the sequence number of the last RTP Media packet that was sent, if at least 1 RTP Media packet was sent; and,

NOTE: The PoC Client is expected to provide the sequence number in all cases when the PoC Client knows the sequence number of the RTP Media packets.

- c. SHALL set the sequence number ignore field to 1, if no RTP Media packets were sent or if the PoC Client is not capable of providing the correct sequence number or if only Discrete Media is bound to the Media-floor Control Entity.
2. SHALL restart timer T10 (Media Burst Release); and,
3. SHALL remain in state 'U: pending MB_Release'.

6.2.5.5.2 T10 (Media Burst release) timer fired N times

On the N:th firing of timer T10 (Media Burst Release), the PoC Client:

1. SHALL enter the 'U: has no permission' state.

6.2.5.5.3 Receive MBCP Media Burst Idle (R: MB_Idle)

Upon receiving a MBCP Media Burst Idle message the PoC Client:

1. SHALL provide Media Burst idle notification to the PoC User;
2. SHALL stop the optional timer T12 (PoC Client retry-after) if it is running;
3. SHALL stop timer T10 (Media Burst Release); and,
4. SHALL enter the 'U: has no permission' state.

6.2.5.5.4 Receive MBCP Media Burst Taken message (R: MB_Taken)

Upon receiving a MBCP Media Burst Taken message the PoC Client:

1. SHALL send a MBCP Media Burst Acknowledgement message if the MBCP Media Burst Taken expects an acknowledgement reply;
2. SHOULD perform the mapping between the SSRC of the PoC Client granted a permission to send a Media Burst and the PoC Address or Nick Name or both, if they are included in the message;
3. SHALL provide Media Burst taken notification to the PoC User;
4. MAY display the PoC Address and Nick Name to the PoC User, if they are included in the message, or alternatively if the PoC Client has a mapping between SSRC of the PoC Client granted the permission to send a Media Burst and the PoC Address or the Nick Name or both;
5. SHOULD start the optional timer T13 (end of RTP Media) if Continuous Media is bound to the Media-floor Control Entity;
6. SHALL stop the optional timer T12 (PoC Client retry-after) if it is running;
7. SHALL stop timer T10 (Media Burst Release); and,
8. SHALL enter the 'U: has no permission' state.

6.2.5.5.5 Receive RTP Media packets (R: Media)

Upon receiving RTP Media packets the PoC Client:

1. SHALL render the Media;
2. MAY display the PoC Address or Nick Name or both based on SSRC of the sending PoC Client, if mapping between those exists in PoC Client;

3. SHOULD start the optional timer T13 (end of RTP Media);
4. SHALL stop timer T10 (Media Burst Release); and,
5. SHALL enter the 'U: has no permission' state.

6.2.5.5.6 Receive MBCP Media Burst Revoke message (R: MB_Revoke)

Upon receiving a MBCP Media Burst Revoke message from the PoC Server, the PoC Client:

1. MAY give information to the PoC User that permission to send a Media Burst is being revoked, if a retry after time is contained in the MBCP Media Burst Revoke message;
2. MAY inform the PoC User of the reason contained in the reason code field received in the MBCP Media Burst Revoke message;
3. MAY inform the PoC User of the retry after time, if a retry after time is contained in the MBCP Media Burst Revoke message;
4. SHOULD start the optional timer T12 (PoC Client retry-after), if a retry after time is contained in the MBCP Media Burst Revoke message; and,

NOTE: The PoC Client does not take any action when T12 expires, but when T12 is running, the PoC Client SHALL not send a MBCP Media Burst Request message.

5. SHALL remain in the 'U: pending MB_Release' state.

6.2.5.6 State: 'U: pending MB_Revoke'

The 'U: pending MB_Revoke' state is a transition state and the PoC Client uses this state when the PoC Client has received a MBCP Media Burst Revoke message and is waiting for any remaining buffered RTP Media packets or any remaining chunks of MSRP SEND requests to be sent.

In this state the PoC Client is sending RTP Media packets, MSRP SEND requests and can receive MBCP Media Burst Control messages.

6.2.5.6.1 Send RTP Media (S: Media)

If the PoC Client has PoC User's encoded Media remaining in the buffer, the PoC Client:

1. SHOULD create and send an RTP Media packet toward the PoC Server.
The RTP Media packet SHALL include:
 - a. The SSRC of the PoC Client; and,
 - b. Other Media and payload attributes as defined in [RFC3550].
2. If the sent RTP Media packet has not been the last packet from the PoC Client's buffer, the PoC Client SHALL remain in the 'U: pending MB_Revoke' state:
3. If the sent RTP Media packet has been the last packet from the PoC Client's buffer, the PoC Client SHALL perform the action in subclause 6.2.5.6.5 "*Send MBCP Media Burst Release message*".

6.2.5.6.2 Receive MBCP Media Burst Idle message (R: MB_Idle)

Upon receiving a MBCP Media Burst Idle message the PoC Client:

1. SHALL stop sending RTP Media packets or MSRP SEND requests;
2. SHALL provide Media Burst idle notification to the PoC User; and,

3. SHALL enter the 'U: has no permission' state.

6.2.5.6.3 Receive MBCP Media Burst Taken message (R: MB_Taken)

Upon receiving a MBCP Media Burst Taken message the PoC Client:

1. SHALL send a MBCP Media Burst Acknowledgement message if the MBCP Media Burst Taken expects an acknowledgement reply;
2. SHALL stop sending RTP Media packets or MSRP SEND requests;
3. SHOULD perform the mapping between the SSRC of the PoC Client granted a permission to send a Media Burst and the PoC Address or Nick Name or both, if they are included in the message;
4. SHALL provide a Media Burst taken notification to the PoC User;
5. MAY display the PoC Address and Nick Name to the PoC User, if they are included in the message, or alternatively if the PoC Client has a mapping between SSRC of the PoC Client granted a permission to send a Media Burst and the PoC Address and /or Nick Name;
6. SHOULD start the optional timer T13 (end of RTP Media) if Continuous Media is bound to the Media-floor Control Entity; and,
7. SHALL enter the 'U: has no permission' state.

6.2.5.6.4 Receive RTP Media (R: Media)

Upon receiving RTP Media packets the PoC Client:

1. SHALL stop sending RTP Media packets or MSRP SEND requests;
2. SHALL render the Media;
3. MAY display the PoC Address or Nick Name or both based on SSRC of the sending PoC Client, if mapping between those exists in PoC Client;
4. SHOULD start the optional timer T13 (end of RTP Media); and,
5. SHALL enter the 'U: has no permission' state.

6.2.5.6.5 Send MBCP Media Burst Release message (S: MB_Release)

When releasing the permission to send Media the PoC Client:

1. SHALL send a MBCP Media Burst Release message towards the PoC Server.

The MBCP Media Burst Release message:

- a. SHALL include the SSRC of the PoC Client; and,
- b. SHOULD include the sequence number of the last RTP Media packet that was sent.

NOTE: The PoC Client is expected to provide the sequence number in all cases where the PoC Client knows the sequence number that is being put into the RTP Media packets.

- c. SHALL set the sequence number validity ignore field to 1, if the PoC Client is not providing the correct sequence number or if only Discrete Media is bound to the Media-floor Control Entity.
2. SHALL start timer T10 (Media Burst Release); and,
 3. SHALL enter the 'U: pending MB_Release' state.

6.2.5.6.6 Receiving a MSRP SEND request (R: MSRP SEND)

Upon receiving an MSRP SEND request the PoC Client:

1. SHALL generate and send a MSRP 200 "OK" response according to rules and procedures of [OMA-PoC-IM];
2. MAY render the received content of the MSRP SEND request for the PoC User;
3. MAY display the PoC Address or Nick Name or both retrieved from the message/cpim From header in the MSRP SEND body; and,
4. SHALL enter the 'U: has no permission' state.

6.2.5.7 State: Any state

This subclause describes the actions to be taken in all states defined for the basic state diagram with the exception of the 'Start-stop' state and the 'Releasing' state.

6.2.5.7.1 Receive MBCP Disconnect message (R: Disconnect)

Upon receiving a MBCP Disconnect message from the PoC Server in any state, the PoC Client:

1. SHALL update the status information of the PoC Session to indicate that the PoC Session within the Pre-established Session is released and the User Plane association between the PoC Session and the Pre-established Session is removed in the PoC Server performing the Participating Function;

NOTE: MBCP Media Burst Acknowledge message is sent in the subclause 6.2.6 "*PoC Session control state diagram – Pre-established Session*".

2. SHALL stop sending MBCP messages, MSRP requests and RTP Media packets towards the PoC Server;
3. SHALL interact with the Control Plane according to the reference [OMA-PoC-CP] "*PoC Client Leaving a PoC Session*"; and,
4. SHALL enter the 'Releasing' state.

6.2.5.7.2 Receive PoC Session release – 1 (R: PoC Session release - 1)

Upon receiving a PoC Session release stage 1 request from the Control Plane when the PoC Session is going to be released or when the PoC Client is leaving the PoC Session or when the PoC Client disconnects from the Media-floor Control Entity or when the Media-floor Control Entity is removed from the PoC Session, the PoC Client:

1. SHALL stop sending MBCP messages, MSRP requests and RTP Media packets towards the PoC Server; and,
2. SHALL enter the 'Releasing' state.

6.2.5.8 State: 'Releasing'

The 'Releasing' state is a transition state. The PoC Client uses this state while waiting for Control Plane to finalize the disconnection of a PoC Session.

6.2.5.8.1 Receive PoC Session release – 2 (R: PoC Session release - 2)

Upon receiving a PoC Session release stage 2 request from the Control Plane when the PoC Session is going to be released or when the PoC Client is leaving the PoC Session or when the PoC Client disconnects from the Media-floor Control Entity or when the Media-floor Control Entity is removed from the PoC Session, the PoC Client:

1. SHALL release all resources including any running timers associated with the PoC Session; and,
2. SHALL enter the 'Start-stop' state and terminate the 'PoC Session control state machine – basic' or terminate the 'PoC Session control state machine – queuing' state machine if queuing is used.

NOTE: If this was a PoC Session using a Pre-established Session, the PoC Client maintains the Pre-established Session.

6.2.5.9 State: 'U: Permission to send limited segment'

The 'U: Permission to send limited segment' state is a stable state. This state is optional and only supported if the PoC Client supports Limited Segment Media Buffer preload capability. The PoC Client will have already buffered Media when entering this state.

The PoC Client uses this state when the PoC Client is permitted to send a limited segment of Media contained in the PoC Clients Media buffer. In this state the PoC Client is allowed to send a limited number of RTP Media packets based on the value of the `tb_seg_preload` parameter received in the SIP 200 "OK" response and can receive MBCP Media Burst Control messages.

Once the PoC Client has completed sending the limited number of RTP Media packets the PoC Client must wait for a MBCP Media Burst Granted message from the PoC Server before sending further RTP Media packets.

NOTE: While the PoC Client is waiting for the MBCP Media Burst Granted message, after the PoC Client has completed sending the limited number of RTP Media packets, the PoC Client buffers any encoded Media from the PoC User for later sending.

6.2.5.9.1 Enter State U: Permission to send limited segment

When entering this state the PoC Client:

1. SHALL start timer T21 (Limited Media Segment) ; and,
2. SHALL enter the 'U: Permission to send limited segment' state.

6.2.5.9.2 Send RTP Media packets (S: Media)

Upon entering this state, provided that the limited Media segment as indicated by the `tbseg_preload` parameter received in the SIP 200 "OK" has not been exceeded, when receiving encoded Media from the PoC User or when buffered Media is available, the PoC Client:

1. SHALL create and send an RTP Media packet toward the PoC Server.

The RTP Media packet SHALL include:

- a. The SSRC of the PoC Client; and,
 - b. Other Media packets and payload attributes as defined in 7.2 "*Media Parameter negotiation*".
2. SHALL remain in the 'U: Permission to send limited segment' state.

6.2.5.9.3 Receive MBCP Media Burst Revoke message (R: MB_Revoke)

Upon receiving a MBCP Media Burst Revoke message from the PoC Server, the PoC Client:

1. SHALL inform the PoC User that the permission to send a Media Burst is being revoked;
2. MAY give information to the PoC User about the reason for revoking the permission to send a Media Burst received in the reason code field;
3. MAY inform the PoC User of the retry after time, if a retry after time is contained in the MBCP Media Burst Revoke message;
4. SHALL stop receiving and encoding PoC User's Media;
5. SHOULD start the optional timer T12 (PoC Client retry-after), if a retry after time is contained in the MBCP Media Burst Revoke message;

NOTE: The PoC Client does not take any action when T12 expires, but when T12 is running, the PoC Client does not send a MBCP Media Burst Request message.

6. If the reason code is 'Media Burst too long', 'Media-floor occupied too long', 'Other reason' or 'Media Burst pre-empted', the PoC Client SHALL enter the 'U: pending MB_Revoke' state; and,
7. If the reason code is 'Only one PoC User', 'No resources available' or 'No permission to send a Media Burst', the PoC Client:
 - a. SHOULD discard any remaining buffered Media; and,
 - b. SHOULD perform the action in 6.2.5.6.5 "*Send MBCP Media Burst Release message*".

6.2.5.9.4 Receive MBCP Media Burst Granted message (R: MB_Granted)

Upon receiving a MBCP Media Burst Granted message from the PoC Server, the PoC Client:

1. SHALL provide Media Burst granted notification to the PoC User if it has not already done so;

NOTE: Providing the Media Burst granted notification to the PoC User prior to receiving the MBCP Media Burst Granted message is an implementation option.

2. MAY provide information about the stop talking timer to the PoC User;
3. MAY provide notification of the number of Participants connected to the Media-floor Control Entity, receiving the Media Burst in the PoC Session, to the PoC User, if included in the message;
4. If MBCP Media Burst Granted message contains Alert-Margin parameter the PoC Client:
 - a. MAY set the initial value of timer T17 (Revocation Alert) by calculating T2-timer minus Alert-Margin and start the timer T17 (Revocation Alert); and,
 - b. MAY start to display the T17 (Revocation Alert) timer, when the value of Alert Margin is zero;
5. SHALL enter the 'U: has permission' state.

6.2.5.9.5 T21 (Limited Media Segment) timer fired

On firing of timer T21 (Limited Media Segment), the PoC Client:

1. SHALL send a MBCP Media Burst Request message towards the PoC Server;
2. SHALL restart timer T21 (Limited Media Segment Burst); and,
3. SHALL remain in the 'U: pending MB_Request' state.

6.2.5.9.6 T21 (Limited Media Segment) timer fired M times

On the M: th firing of timer T21 (Limited Media Segment), the PoC Client:

1. MAY provide a Media Burst request timeout notification to the PoC User; and,

NOTE: The PoC Client can discard buffered Media.

2. SHALL enter the 'U: has no permission' state.

6.2.5.9.7 Send MBCP Media Burst Release message (S: MB_Release)

Upon receiving an indication from the PoC User to release permission to send Media, the PoC Client:

1. SHALL send a MBCP Media Burst Release message towards the PoC Server.

The MBCP Media Burst Release message:

- a. SHALL set the sequence number ignore field to 1, (because no MBCP Media Burst Granted message was received).

NOTE: The PoC Client can discard buffered Media.

2. SHALL start timer T10 (Media Burst Release); and,
3. SHALL enter the 'U: pending MB_Release' state.

6.2.5.10 State: 'U: Local Grant'

The 'U: Local Grant' state is a transition state, and the PoC Client uses this state when the PoC Client is waiting for response to a MBCP Media Burst Request message.

In this state the PoC Client can receive RTP Media packets and MBCP Media Burst Control messages.

Timer T11 (Media Burst Request) is running in this state.

6.2.5.10.1 Receive MBCP Media Burst Granted message (R: MB_Granted)

Upon receiving a MBCP Media Burst Granted message from the PoC Server, the PoC Client:

1. MAY provide information about the stop talking timer to the PoC User;
2. MAY provide notification of the number of Participants connected to the Media-floor Control Entity, receiving the Media Burst in the PoC Session, to the PoC User, if included in the message;
3. SHALL stop timer T11 (Media Burst Request);
4. If MBCP Media Burst Granted message contains Alert-Margin parameter the PoC Client
 - a. MAY set the initial value of timer T17 (Revocation Alert) by calculating T2-timer minus Alert-Margin and start the timer T17 (Revocation Alert); and,
 - b. MAY start to display the T17 (Revocation Alert) timer, when the value of Alert Margin is zero;
5. SHALL enter the 'U: has permission' state.

6.2.5.10.2 Receive MBCP Media Burst Taken message (R: MB_Taken)

Upon receiving a MBCP Media Burst Taken message from the PoC Server, the PoC Client:

1. SHALL send a MBCP Media Burst Acknowledgement message if the MBCP Media Burst Taken message expects an acknowledgement reply;
2. SHALL ignore encoded Media from the PoC User;
3. SHOULD perform the mapping between the SSRC of the PoC Client granted a permission to send a Media Burst and the PoC Address or Nick Name or both, if they are included in the message;
4. SHALL provide a Media Burst taken notification to the PoC User;
5. MAY display the PoC Address and Nick Name to the PoC User, if they are included in the message;
6. SHALL stop timer T11 (Media Burst Request);
7. SHOULD start the optional timer T13 (end of RTP Media); and,
8. SHALL enter the 'U: has no permission' state.

6.2.5.10.3 Receive MBCP Media Burst Deny message (R: MB_Deny)

Upon receiving a MBCP Media Burst Deny message from the PoC Server, the PoC Client:

1. SHALL ignore encoded voice from the PoC User;
2. SHALL provide Media Burst deny notification to the PoC User;
3. MAY display the Media Burst deny reason to the PoC User, if it is included in the message;
4. SHALL stop timer T11 (Media Burst Request); and,
5. SHALL enter the 'U: has no permission' state.

6.2.5.10.4 T11 (Media Burst request) timer fired

On firing of timer T11 (Media Burst Request), the PoC Client:

1. SHALL send a MBCP Media Burst Request message towards the PoC Server;
2. SHALL restart timer T11 (Media Burst Request); and,
3. SHALL remain in the 'U: Local Grant' state.

6.2.5.10.5 T11 (Media Burst request) timer fired N times

On the N:th firing of timer T11 (Media Burst Request), the PoC Client:

1. SHALL ignore encoded Media from the PoC User;
2. MAY provide a Media Burst request timeout notification to the PoC User; and,
3. SHALL enter the 'U: has no permission' state.

6.2.5.10.6 Receive RTP Media packets (R: Media)

Upon receiving RTP Media packets the PoC Client:

1. SHALL ignore encoded voice from the PoC User;
2. SHALL provide Media Burst deny notification to the PoC User;
3. SHALL render the Media;
4. MAY display the PoC Address or Nick Name or both based on SSRC of the sending PoC Client, if mapping between those exists in PoC Client;
5. SHALL stop timer T11 (Media Burst Request);
6. SHOULD start the optional timer T13 (end of RTP Media); and,
7. SHALL enter the 'U: has no permission' state.

6.2.5.10.7 Send MBCP Media Burst Release message (S: MB_Release)

Upon receiving an indication from the PoC User to release permission to send Media, the PoC Client:

1. SHALL send a MBCP Media Burst Release message towards the PoC Server.

The MBCP Media Burst Release message:

- a. SHOULD include the sequence number of the last RTP Media packet that was sent, if at least 1 RTP Media packet was sent; and,

NOTE: The PoC Client is expected to provide the sequence number in all cases when the PoC Client knows the sequence number of the RTP Media packets.

- b. SHALL set the sequence number ignore field to 1, if no RTP Media packets were sent or if the PoC Client is not capable of providing the correct sequence number.
2. SHALL start timer T10 (Media Burst Release); and,
3. SHALL enter the 'U: pending MB_Release' state.

6.2.5.10.8 Send RTP Media packets (S: Media)

Upon receiving encoded voice from the PoC User, the PoC Client:

1. SHALL create and send an RTP Media packet toward the PoC Server.

The RTP Media packet SHALL include:

- a. The SSRC of the PoC Client; and,
 - b. Other Media packets and payload attributes as defined in [RFC3550].
2. SHALL remain in the 'U: Local Grant' state.

6.2.6 PoC Session control state diagram – Pre-established Session

If the PoC Client supports Pre-established Session, the PoC Client SHALL support the state diagram and the state transitions specified in this subclause.

NOTE: The PoC Client can only use Pre-established Sessions if supported by the Home PoC Server.

A Pre-established Session has two states: Pre-established Session_Not_in_use and Pre-established Session_In_use. The states are partly controlled on the Control Plane [OMA-PoC-CP].

A PoC Client MAY have several Pre-established Sessions at a time.

Figure 4 "*PoC Client state transition diagram for Pre-established Session*" shows the Pre-established PoC User states (U states) and the state transitions.

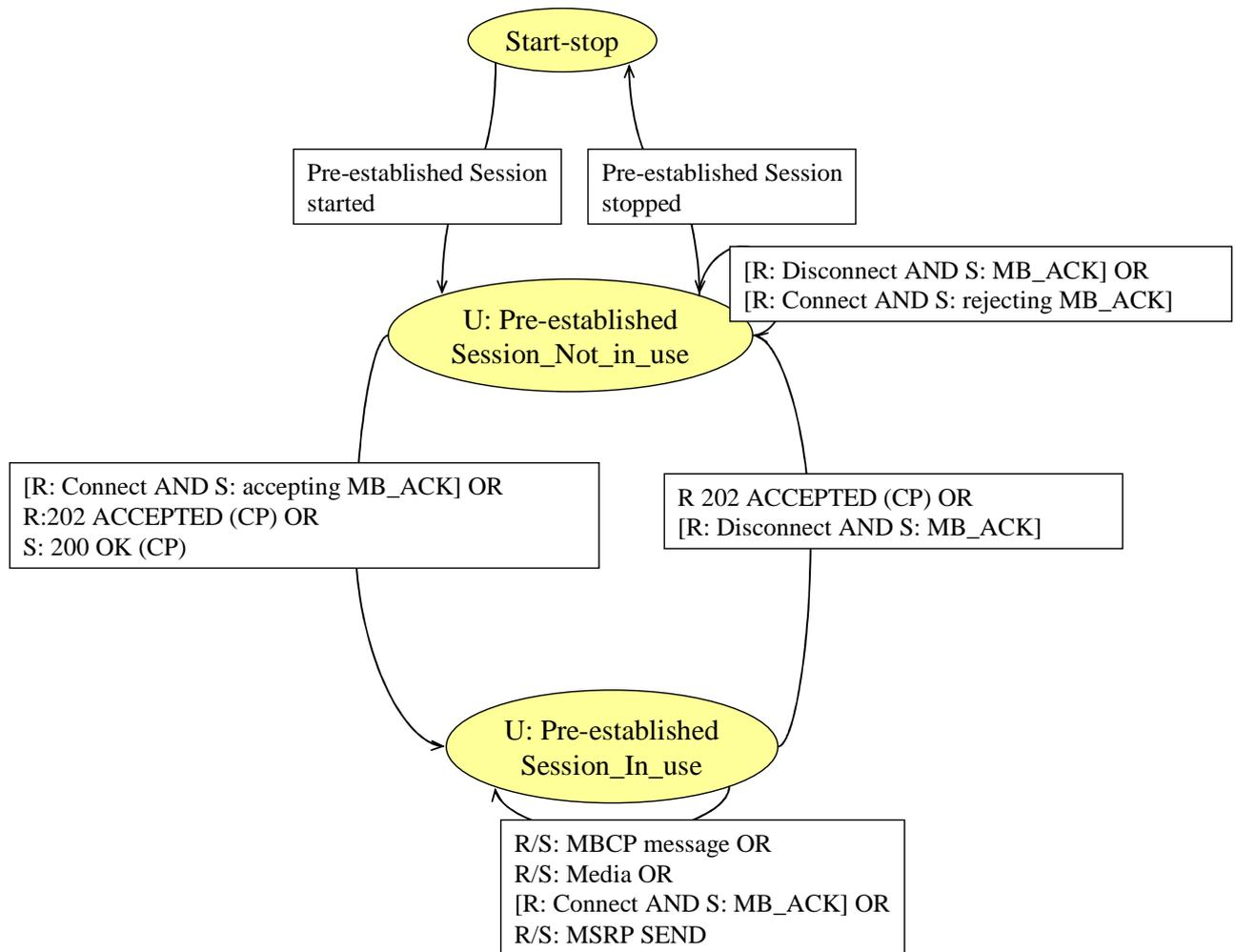

Figure 4: PoC Client state transition diagram for Pre-established Session

The PoC Client SHALL create one instance of the Pre-established Session state machine per Pre-established Session.

State details are explained in the following subclauses.

If a MBCP message, SIP request or RTP Media packet arrives in any state and there is no procedure specified in the subclauses below the PoC Client SHALL discard the MBCP message, SIP request or RTP Media packet and SHALL remain in the current state.

6.2.6.1 State 'Start-stop'

In this state, no Pre-established Session exists.

6.2.6.1.1 Pre-established Session started

When a Pre-established Session is created between the PoC Server and a PoC Client, the PoC Client:

1. SHALL initialize any needed User Plane resources for the Pre-established Session; and,
2. SHALL enter the 'G: Pre-established Session_Not_in_use' state.

6.2.6.2 State 'U: Pre-established Session_Not_in_use'

The 'U: Pre-established Session_Not_in_use' state is a stable state. The PoC Client is in this state when Pre-established Session is established, but it is not used for PoC Session.

In this state the PoC Client can receive PoC Session initiation message and MBCP messages.

6.2.6.2.1 Receive MBCP Connect message (R: Connect)

Upon receiving a MBCP Connect message the PoC Client:

1. SHALL create an instance of the PoC Session control state machine as defined in subclause 6.2.5 "*PoC Session control state diagram – basic*" or 6.2.9 "*PoC Session control state diagram – queuing*" if queuing of Media Burst requests are used; and,
2. if the PoC Client accepts the incoming PoC Session the PoC Client:
 - a. SHALL send MBCP Media Burst Acknowledgement message with the reason code 'Accepted';
 - b. SHALL use only the Media Streams of the Pre-established Session which are indicated as used in the associated PoC Session in the Media-Streams field, if MBCP Connect contains the Media-Streams field; and,
 - c. SHALL enter the 'U: Pre-established Session_In_use' state.
3. Otherwise the PoC Client:
 - a. SHALL send MBCP Media Burst Acknowledgement message with the reason code 'Busy' or 'Not accepted'; and,
 - b. SHALL remain in the 'U: Pre-established Session_Not_in_use' state.

6.2.6.2.2 Void

6.2.6.2.3 Receive SIP 202 "Accepted" response (R: 202 ACCEPTED (CP))

Upon receiving a SIP 202 "Accepted" response for the SIP REFER request sent to initiate a PoC Session as specified in the [OMA-PoC-CP] "*PoC Client initiates and Ad-hoc PoC Group and I-I PoC Session*", or "*PoC Client initiates a Pre-arranged Group Session or joining a Chat PoC Group*" or "*PoC Client rejoining a PoC Session*" the PoC Client:

1. SHALL create an instance of the PoC Session control state machine as defined in subclause 6.2.5 "*PoC Session control state diagram – basic*" or 6.2.9 "*PoC Session control state diagram – queuing*" if queuing of Media Burst requests are used; and,
2. SHALL enter the 'U: Pre-established Session_In_use' state.

6.2.6.2.4 Pre-established Session stopped

When the Pre-established Session between the PoC Client and the PoC Server is released, the PoC Client:

1. SHALL release any User Plane resources including any running timers associated with the Pre-established Session; and,
2. SHALL enter the 'Start-stop' state.

6.2.6.2.5 Void

6.2.6.2.6 Receive MBCP Disconnect (R: Disconnect)

Upon receiving a MBCP Disconnect message the PoC Client:

1. SHALL send MBCP Media Burst Acknowledgement message; and,

2. SHALL remain in the 'U: Pre-established Session_Not_in_use' state.

6.2.6.2.7 Send SIP 200 "OK" response to the SIP re-INVITE request (S: 200 OK (CP))

Upon sending the SIP 200 "OK" response to the SIP re-INVITE request of the Pre-established Session initiating a PoC Session as specified in the [OMA-PoC-CP] "*PoC Client invited to a PoC Session*", the PoC Client:

1. SHALL create an instance of the PoC Session control state machine as defined in subclause 6.2.5 "*PoC Session control state diagram – basic*" or 6.2.9 "*PoC Session control state diagram – queuing*" if queuing of Media Burst requests are used; and,
2. SHALL enter the 'U: Pre-established Session_In_use' state.

6.2.6.3 State 'U: Pre-established Session_In_use'

The 'U: Pre-established Session_In_use' state is a stable state. The PoC Client is in this state when Pre-established Session is established and it is used for PoC Session.

In this state the PoC Client can receive RTP Media packets, MSRP requests or responses, MBCP messages and indication of the PoC Session release.

NOTE: Reception and sending of the MSRP response and the MSRP REPORT request is handled according to rules and procedures of [OMA-PoC-IM].

6.2.6.3.1 Receive MBCP Connect message (R: Connect)

Upon receiving a MBCP Connect message the PoC Client:

1. SHALL send MBCP Media Burst Acknowledgement message;
2. SHALL start T11 (Media Burst Request) timer, if the T11 (Media Burst Request) timer is not running yet and if the PoC Session control state machine is in the state "U: pending MB_Request";
3. SHALL use only the Media Streams of the Pre-established Session which are indicated as used in the associated PoC Session in the Media-Streams field, if MBCP Connect contains the Media-Streams field; and,
4. SHALL remain in the 'U: Pre-established Session_In_use' state.

6.2.6.3.2 Receive other MBCP message (R: MBCP message)

Upon receiving a MBCP message the PoC Client:

1. SHALL act as specified in the subclause 6.2.5 "*PoC Session control state diagram – basic*" or in the subclause 6.2.9 "*PoC Session control state diagram – queuing*" if queuing of Media Burst requests are used; and,
2. SHALL remain in the 'Pre-established Session_In_use' state.

6.2.6.3.3 Receive RTP Media packets (R: Media)

Upon receiving RTP Media packets the PoC Client:

1. SHALL act as specified in the subclause 6.2.5 "*PoC Session control state diagram – basic*" or 6.2.9 "*PoC Session control state diagram – queuing*" if queuing of Media Burst requests are used; and,
2. SHALL remain in the 'Pre-established Session_In_use' state.

6.2.6.3.4 Receive SIP 202 "Accepted" (R: 202 ACCEPTED (CP))

Upon receiving a SIP 202 "Accepted" response to the sent SIP REFER request as described in [OMA-PoC-CP] "*Leaving a PoC Session – Pre-established Session case*" when the PoC Session is released, but the Pre-established Session is kept alive the PoC Client:

1. SHALL enter the 'U: Pre-established Session_Not_in_use' state; and,
2. SHALL terminate the instance of the PoC Session control state machine as defined in subclause 6.2.5 "*PoC Session control state diagram – basic*" or 6.2.9 "*PoC Session control state diagram – queuing*" if queuing of Media Burst requests are used.

6.2.6.3.5 Send MBCP message (S: MBCP message)

When sending a MBCP message the PoC Client:

1. SHALL act as specified in subclause 6.2.5 "*PoC Session control state diagram – basic*" or 6.2.9 "*PoC Session control state diagram – queuing*" if queuing of Media Burst request are used; and,
2. SHALL remain in the 'Pre-established Session_In_use' state.

6.2.6.3.6 Send RTP Media packets (S: Media)

When sending RTP Media packets the PoC Client:

1. SHALL act as specified in subclause 6.2.5.4.1 "*Send RTP Media packets (S: Media)*"; and,
2. SHALL remain in the 'Pre-established Session_In_use' state.

6.2.6.3.7 Receive MBCP Disconnect (R: Disconnect)

Upon receiving a MBCP Disconnect message the PoC Client:

1. SHALL send MBCP Media Burst Acknowledgement message;
2. SHALL enter the 'U: Pre-established Session_Not_in_use' state; and,
3. SHALL act as specified in subclause 6.2.5 "*PoC Session control state diagram – basic*" or 6.2.9 "*PoC Session control state diagram – queuing*" if queuing of Media Burst requests are used.

6.2.6.3.8 Receive a MSRP SEND request (R: MSRP SEND)

Upon receiving an MSRP SEND request the PoC Client:

1. SHALL act as specified in the subclause 6.2.5 "*PoC Session control state diagram – basic*" or 6.2.9 "*PoC Session control state diagram – queuing*" if queuing of Media Burst requests are used; and,
2. SHALL remain in the 'Pre-established Session_In_use' state.

6.2.6.3.9 Send a MSRP SEND request (S: MSRP SEND)

When sending an MSRP SEND request the PoC Client:

1. SHALL act as specified in subclause 6.2.5.4.5 "*Sending a MSRP SEND request (S: MSRP SEND)*"; and,
2. SHALL remain in the 'Pre-established Session_In_use' state.

6.2.7 PoC Session control state diagram – Simultaneous per PoC Client

In the case PoC Client has Simultaneous PoC Sessions with Continuous Media the PoC Client

1. SHALL follow for each PoC Session the PoC Session specific state diagrams and state transitions specified in the subclause 6.2.5 "*PoC Session control state diagram – basic*" or 6.2.9 "*PoC Session control state diagram – queuing*" if queuing of Media Burst requests are used, if MBCP is used; or,
2. SHALL follow for each PoC Session the PoC Session specific state diagrams and state transitions specified in [OMA-PoC-1-UP] "*PoC Session control state diagram – basic*" or [OMA-PoC-1-UP] "*PoC Session control state diagram – queuing*" if queuing of Talk Burst requests are used, if TBCP is used.

NOTE: TBCP is defined in [OMA-PoC-1-UP].

The PoC Client MAY have more than one PoC Sessions established at a time.

For the overall handling of Simultaneous PoC Sessions containing Continuous Media the PoC Client SHALL support the state diagram and the state transitions specified in this subclause.

Transitions between different PoC Sessions are dictated by actions of the PoC User and changes in the Simultaneous PoC Session states. The changes of the states are partly controlled on the Control Plane [OMA-PoC-CP].

Figure 5 "Simultaneous PoC Sessions state diagram – per PoC Client." shows the Simultaneous PoC Sessions PoC Client states (C states) per PoC Client and the state transitions.

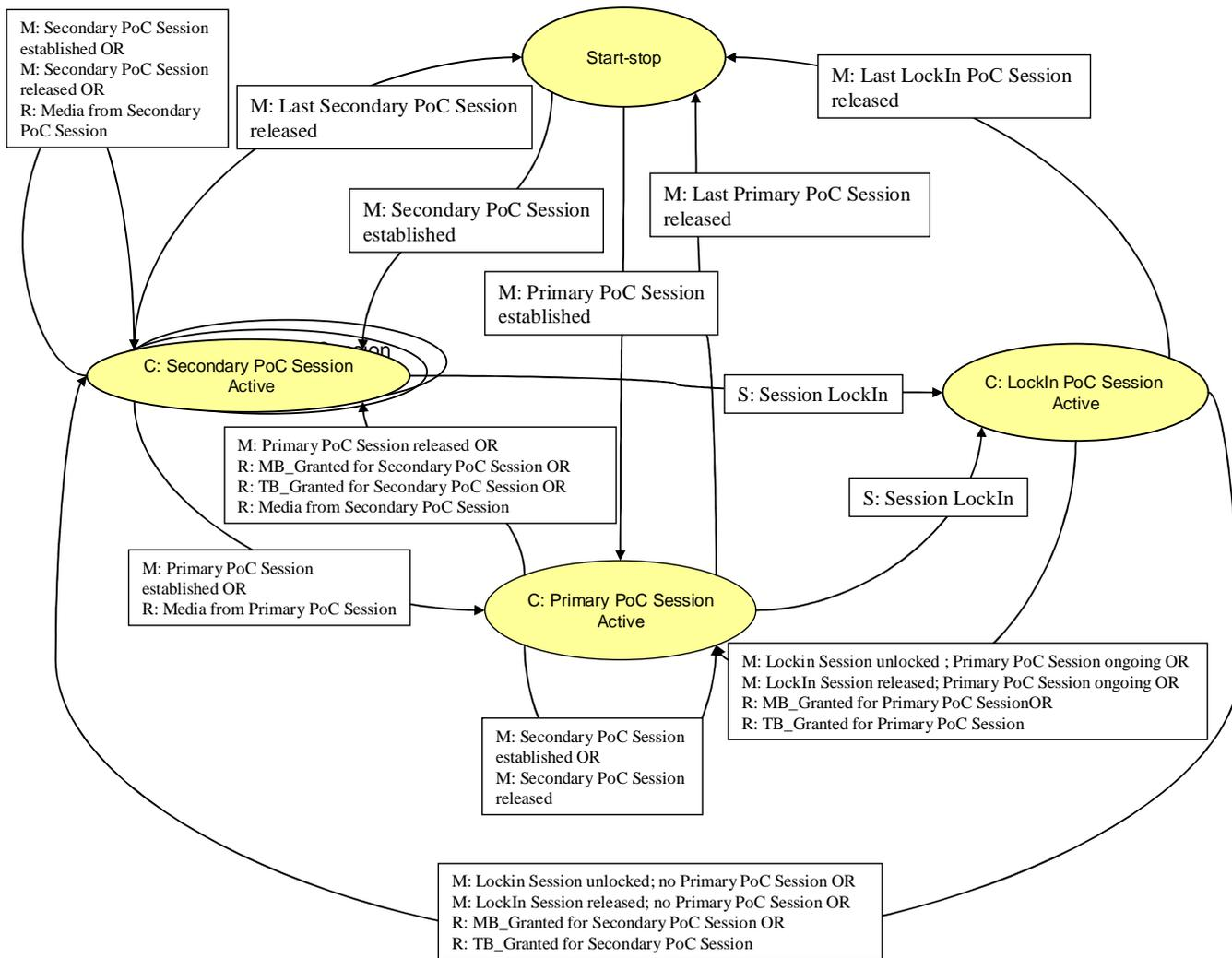

Figure 5: Simultaneous PoC Sessions state diagram – per PoC Client

The state diagram in Figure 5 "Simultaneous PoC Sessions state diagram – per PoC Client" applies when the PoC Client for a PoC User supports several PoC Sessions containing Continuous Media simultaneously.

State details are explained in the following subclauses.

If a MBP message, TBCP message, SIP request or RTP Media packet arrives in any state and there is no procedure specified for it in the subclauses below the PoC Client SHALL discard the MBP message, TBCP message, SIP request or RTP Media packet and SHALL remain in the current state.

NOTE: MSRP request and MSRP response relaying is not affected by the state machine.

6.2.7.1 State 'Start-stop'

In this state no PoC Session containing Continuous Media exists.

6.2.7.1.1 Monitor Primary PoC Session establishment (M: Primary PoC Session established)

When a Primary PoC Session including Continuous Media is established or when a Continuous Media is connected in the previously Discrete Media only Primary PoC Session as specified in the [OMA-PoC-CP] "*PoC Client setting PoC Session priority*", the PoC Client:

1. SHALL create an instance of the Simultaneous PoC Sessions state machine per PoC Client; and,
2. SHALL enter the 'C: Primary PoC Session Active' state.

6.2.7.1.2 Monitor Secondary PoC Session establishment (M: Secondary PoC Session established)

When a Secondary PoC Session including Continuous Media is established or when a Continuous Media is connected in the previously Discrete Media only Secondary PoC Session as specified in the [OMA-PoC-CP] "*PoC Client setting PoC Session priority*", the PoC Client:

1. SHALL create an instance of the Simultaneous PoC Sessions state machine per PoC Client; and,
2. SHALL enter the 'C: Secondary PoC Session Active' state.

6.2.7.2 State: 'C: Primary PoC Session Active'

In this state a Primary PoC Session exists as an Active PoC Session. The "C: Primary PoC Session Active" is a stable state.

6.2.7.2.A General

In the "C: Primary PoC Session Active" state the PoC Client:

1. SHALL send and receive RTP Media packets , TBCP messages and MBP messages for the Active PoC Session; and,
2. SHOULD send and receive TBCP messages and MBP messages for all other established PoC Sessions containing Continuous Media.

6.2.7.2.1 Monitor Primary PoC Session release when no other PoC Sessions are ongoing (M: Last Primary PoC Session released)

When a Primary PoC Session is released or when all Continuous Media are disconnected from the PoC Session and no other PoC Sessions containing Continuous Media for the same PoC Client are established as specified in [OMA-PoC-CP] "*PoC Client setting PoC Session priority*" the PoC Client:

1. SHALL enter the 'Start-stop' state.

6.2.7.2.2 Send SDP with Session LockIn (S: Session LockIn)

When the PoC Client locks this PoC Session containing Continuous Media as specified in [OMA-PoC-CP] "*PoC Client handling of PoC Session locking*" the PoC Client:

1. SHALL enter the 'C: LockIn PoC Session Active' state.

6.2.7.2.3 Monitor Secondary PoC Session release (M: Secondary PoC Session released)

When a Secondary PoC Session containing Continuous Media is released or when all Continuous Media are disconnected from the PoC Session as specified in [OMA-PoC-CP] the PoC Client:

1. SHALL remain in PoC Client state 'C: Primary PoC Session Active'.

6.2.7.2.4 Monitor Secondary PoC Session establishment (M: Secondary PoC Session established)

When a Secondary PoC Session containing Continuous Media is established or when a Continuous Media is connected in the previously Discrete Media only Secondary PoC Session as specified in [OMA-PoC-CP] "*PoC Client setting PoC Session priority*" the PoC Client:

1. SHALL remain in PoC Client state 'C: Primary PoC Session Active'.

6.2.7.2.5 Monitor Primary PoC Session release (M: Primary PoC Session released)

When a Primary PoC Session containing Continuous Media is released or when all Continuous Media are disconnected from the Primary PoC Session as specified in the [OMA-PoC-CP] and other PoC Sessions containing Continuous Media for the same PoC User are established as specified in [OMA-PoC-CP] "*PoC Client setting PoC Session priority*" the PoC Client:

1. SHALL enter the 'C: Secondary PoC Session Active'.

6.2.7.2.6 Receive Media Burst Granted message (R: MB_Granted for Secondary PoC Session)

When the PoC Client receives a MBCP Media Burst Granted message in response to a MBCP Media Burst requests message for a Secondary PoC Session containing Continuous Media, the PoC Client:

1. SHALL enter the 'C: Secondary PoC Session active' state.

6.2.7.2.7 Receive RTP Media packets (R: Media from Secondary PoC Session)

Upon receiving RTP Media packets from a Secondary PoC Session the PoC Client:

1. SHALL enter the 'C: Secondary PoC Session Active' state.

6.2.7.2.8 Receive Talk Burst Granted message (R: TB_Granted for Secondary PoC Session)

When the PoC Client receives a TBCP Talk Burst Granted message in response to a TBCP Talk Burst request message for a Secondary PoC Session containing Continuous Media, the PoC Client:

1. SHALL enter the 'C: Secondary PoC Session active' state.

6.2.7.3 State: 'C: Secondary PoC Session Active'

In this state a Secondary PoC Session containing Continuous Media exists as an Active PoC Session. The 'C: Secondary PoC Session Active' state is a stable state.

6.2.7.3.A General

In the "C: Secondary PoC Session Active" state the PoC Client:

1. SHALL send and receive RTP Media packets, TBCP messages and MBCP messages for the Active PoC Session; and,

2. SHOULD send and receive MBCP messages and TBCP messages for all other established PoC Sessions containing Continuous Media.

6.2.7.3.1 Monitor Secondary PoC Session release when no other PoC Sessions are ongoing (M: Last Secondary PoC Session released)

When the Secondary PoC Session containing Continuous Media is released or when all Continuous Media are disconnected from the PoC Session as specified in [OMA-PoC-CP] and no other PoC Sessions containing Continuous Media for the same PoC Client are established as specified in [OMA-PoC-CP] "*PoC Client setting PoC Session priority*" the PoC Client:

1. SHALL enter the 'Start-stop' state.

6.2.7.3.2 Send SDP with Session LockIn (S: Session LockIn)

When a Secondary PoC Session containing Continuous Media is an Active PoC Session and the PoC Client locks this PoC Session containing Continuous Media as specified in [OMA-PoC-CP] "*PoC Client handling of PoC Session locking*" the PoC Client:

1. SHALL enter the 'C: LockIn PoC Session Active'.

6.2.7.3.3 Monitor Primary PoC Session establishment (M: Primary PoC Session established)

When a Primary PoC Session containing Continuous Media is established or when a Continuous Media is connected in the previously Discrete Media only Primary PoC Session as specified in the [OMA-PoC-CP] "*PoC Client setting PoC Session priority*", and fulfils the criteria defined in the subclause [OMA-PoC-CP] "*Procedures at the PoC Client*" to be activated the PoC Client:

1. SHALL enter the 'C: Primary PoC Session Active'.

6.2.7.3.4 Receive RTP Media packets (R: Media from Primary PoC Session)

Upon receiving RTP Media packets from a Primary PoC Session containing Continuous Media the PoC Client:

1. SHALL enter the 'C: Primary PoC Session Active' state.

6.2.7.3.5 Monitor Secondary PoC Session release (M: Secondary PoC Session released)

When the Secondary PoC Session containing Continuous Media is released or when all Continuous Media are disconnected from the PoC Session as specified in [OMA-PoC-CP] and at least one other PoC Sessions containing Continuous Media for the same PoC Client are established as specified in [OMA-PoC-CP] and fulfils the criteria defined in the subclause 7.5.1 "*Procedures at the PoC Client*" to be activated the PoC Client:

1. SHALL remain in the state 'C: Secondary PoC Session Active'.

6.2.7.3.6 Monitor Secondary PoC Session establishment (M: Secondary PoC Session established)

When a Secondary PoC Session containing Continuous Media is established or when a Continuous Media is connected in the previously Discrete Media only Secondary PoC Session as specified in the [OMA-PoC-CP] "*PoC Client setting PoC Session priority*", the PoC Client:

1. SHALL remain in PoC Client state 'C: Secondary PoC Session Active'.

6.2.7.3.7 Receive RTP Media packets (R: Media from Secondary PoC Session)

Upon receiving RTP Media packets from a Secondary PoC Session containing Continuous Media different than the Active PoC Session, the PoC Client:

1. SHALL enter in the 'C: Secondary PoC Session Active' state for the Secondary PoC Session it received RTP Media packets from.

6.2.7.4 State: 'C: LockIn PoC Session Active'

In this state a LockIn PoC Session containing Continuous Media exists and is an Active PoC Session. The 'C: LockIn PoC Session Active' state is a stable state.

6.2.7.4.A General

In the "C: LockIn PoC Session Active" state the PoC Client:

1. SHALL send and receive RTP Media packets, TBCP messages and MBCP messages for the Active PoC Session;
2. SHOULD receive MBCP messages and TBCP messages from any other PoC Session; and,
3. MAY prevent PoC User to request Media Burst for any other PoC Sessions containing Continuous Media.

6.2.7.4.1 Monitor LockIn PoC Session release and no other PoC Session are ongoing (M: Last LockIn PoC Session released)

When a LockIn PoC Session containing Continuous Media is released or when all Continuous Media are disconnected from the PoC Session as specified in [OMA-PoC-CP] and no other PoC Sessions containing Continuous Media for the same PoC Client are ongoing the PoC Client:

1. SHALL enter the 'Start-stop' state.

6.2.7.4.2 Monitor LockIn PoC Session release and Primary PoC Session ongoing (M: LockIn PoC Session released; Primary PoC Session ongoing)

When a LockIn PoC Session containing Continuous Media is released or when all Continuous Media are disconnected from the PoC Session as specified in [OMA-PoC-CP] and a Primary PoC Sessions containing Continuous Media for the same PoC Client is already established the PoC Client:

1. SHALL enter the 'C: Primary PoC Session active' state.

6.2.7.4.3 Monitor LockIn PoC Session release and no Primary PoC Session ongoing (M: LockIn PoC Session released; no Primary PoC Session)

When a LockIn PoC Session containing Continuous Media is released or when all Continuous Media are disconnected from the PoC Session as specified in [OMA-PoC-CP] and no Primary PoC Session containing Continuous Media for the same PoC Client is established and at least one Secondary PoC Session containing Continuous Media for the same PoC Client is established and fulfils criteria defined in the subclause 7.5.1 "*Procedures at the PoC Client*" to be activated the PoC Client:

1. SHALL enter the 'C: Secondary PoC Session active' state.

6.2.7.4.4 Monitor LockIn PoC Session is unlocked and Primary PoC Session ongoing (M: LockIn PoC Session unlocked; Primary PoC Session ongoing)

When a LockIn PoC Session containing Continuous Media is unlocked as specified in [OMA-PoC-CP] "*PoC Client handling of PoC Session locking*" and a Primary PoC Sessions containing Continuous Media for the same PoC User is already established the PoC Client:

1. SHALL enter the 'C: Primary PoC Session active' state.

6.2.7.4.5 Monitor LockIn PoC Session is unlocked and no Primary PoC Session ongoing (M: LockIn PoC Session unlocked; no Primary PoC Session)

When a LockIn PoC Session containing Continuous Media is unlocked, as specified in [OMA-PoC-CP] "*PoC Client handling of PoC Session locking*", and no Primary PoC Session containing Continuous Media is ongoing and at least one Secondary PoC Session containing Continuous Media for the same PoC Client and fulfils criteria defined in the subclause 7.5.1 "*PoC Client handling of PoC Session locking*", to be activated, the PoC Client:

1. SHALL enter the 'C: Secondary PoC Session active' state.

6.2.7.4.6 Receive MBCP Media Burst Granted message for Primary PoC Session (R: MB_Granted for Primary PoC Session)

When the PoC Client receives a MBCP Media Burst Granted message in response to a MBCP Media Burst requests message for the Primary PoC Session containing Continuous Media to the PoC Server, the PoC Client:

1. SHALL enter the 'C: Primary PoC Session active' state.

6.2.7.4.7 Receive MBCP Media Burst Granted message for Secondary PoC Session (R: MB_Granted for Secondary PoC Session)

When the PoC Client receives a MBCP Media Burst Granted message in response to a MBCP Media Burst Request message for a Secondary PoC Session containing Continuous Media, the PoC Client:

1. SHALL enter the 'C: Secondary PoC Session active' state.

6.2.7.4.8 Receive TBCP Talk Burst Granted message for Primary PoC Session (R: TB_Granted for Primary PoC Session)

When the PoC Client receives a TBCP Talk Burst Granted message in response to a TBCP Talk Burst request message for the Primary PoC Session containing Continuous Media, the PoC Client:

1. SHALL enter the 'C: Primary PoC Session active' state.

6.2.7.4.9 Receive TBCP Talk Burst Granted message for Secondary PoC Session (R: TB_Granted for Secondary PoC Session)

When the PoC Client receives a TBCP Talk Burst Granted message in response to a TBCP Talk Burst Request message for a Secondary PoC Session containing Continuous Media, the PoC Client:

1. SHALL enter the 'C: Secondary PoC Session active' state.

6.2.8 PoC Session control state diagram – Simultaneous PoC Sessions

In the case PoC Client has Simultaneous PoC Sessions the PoC Client:

1. SHALL follow for each PoC Session the PoC Session specific state diagrams and state transitions specified in the subclause 6.2.5 "*PoC Session control state diagram – basic*" or 6.2.9 "*PoC Session control state diagram – queuing*" if queuing of Media Burst requests are used, if MBCP is used;
or,
2. SHALL follow for each PoC Session the PoC Session specific state diagrams and state transitions specified in [OMA-PoC-1-UP] "*PoC Session control state diagram – basic*" or [OMA-PoC-1-UP] "*PoC Session control state diagram – queuing*" if queuing of Talk Burst requests are used, if TBCP is used.

For the handling of each of the Simultaneous PoC Sessions containing Continuous Media the PoC Client SHALL support the state diagram and the state transitions specified in this subclause.

Transitions between different PoC Sessions are dictated by actions of the PoC User and changes in the Simultaneous PoC Session states. The changes of the states are partly controlled by the Control Plane as specified in [OMA-PoC-CP] "*Simultaneous PoC Session control procedures*".

Figure 6 "*PoC Session control state diagram – Simultaneous PoC Sessions*" shows Simultaneous PoC Sessions states and the state transitions for a PoC User per PoC Session.

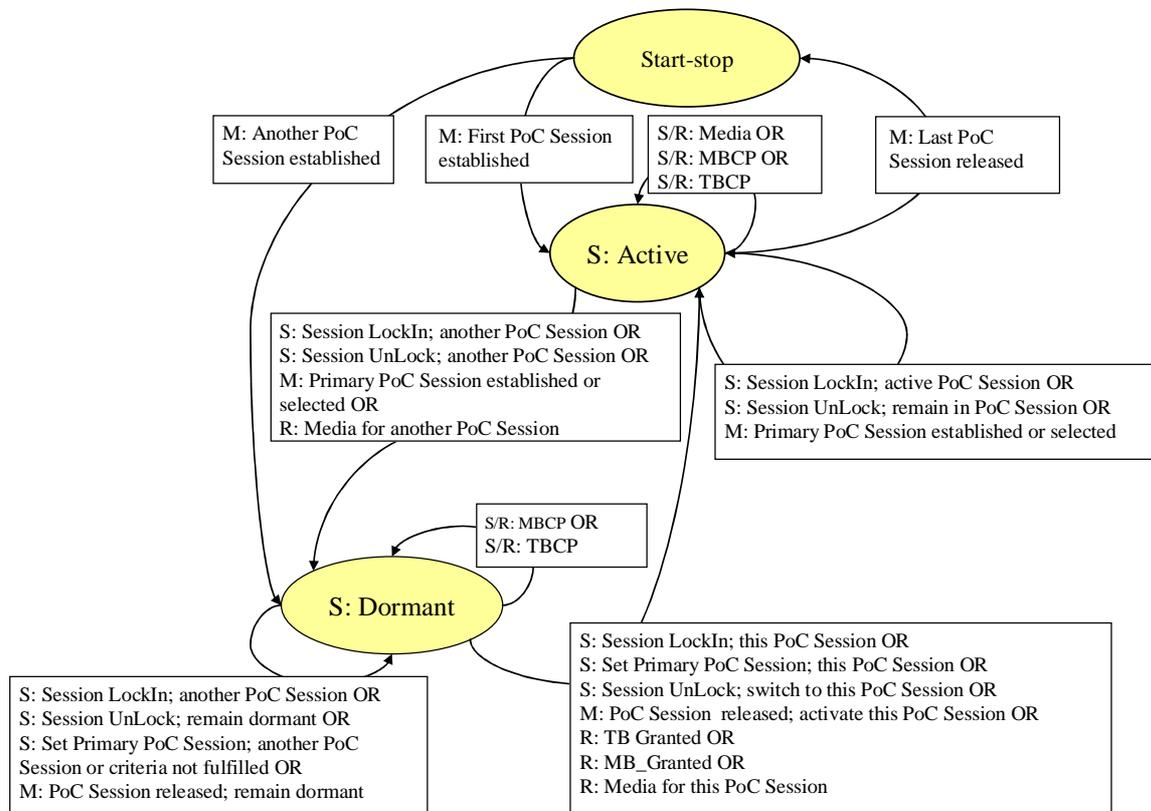

Figure 6: PoC Session control state diagram – Simultaneous PoC Sessions

The State Diagram in Figure 6 "PoC Session control state diagram - Simultaneous PoC Sessions" applies to one PoC Session containing Continuous Media out of multiple Simultaneous PoC Sessions supported by the PoC Client.

The PoC Client SHALL create an instance of the state machine for each PoC Session containing Continuous Media.

State details are explained in the following subclauses.

If a MBCP message, TBCP message, SIP request or RTP Media packet arrives in any state and there is no procedure specified for it in the subclauses below the PoC Client SHALL discard the MBCP message, TBCP message, SIP request or RTP Media packet and SHALL remain in the current state.

NOTE: MSRP request and MSRP response relaying is not affected by the state machine.

6.2.8.1 State 'Start-Stop'

In this state no PoC Session containing Continuous Media exists.

6.2.8.1.1 Monitor first PoC Session established (M: First PoC Session established)

When a PoC Session containing Continuous Media exists is established or when a Continuous Media is connected in the previously Discrete Media only PoC Session as specified in [OMA-PoC-CP] "PoC Client procedures at PoC Session initialization" and in case there is no Active PoC Session for the same PoC User the PoC Client:

1. SHALL create an instance of the general Media Burst operation state machine as specified in 6.2.5 "*PoC Session control state diagram – basic*" or 6.2.9 "*PoC Session control state diagram – queuing*" if queuing of Media Burst requests are used, if MBCP is used;
2. SHALL create an instance of the general Talk Burst operation state machine as specified in [OMA-PoC-1-UP] "*PoC Session control state diagram – basic*" or [OMA-PoC-1-UP] "*PoC Session control state diagram – queuing*" if queuing of Talk Burst requests are used, if TBCP is used; and,
3. SHALL enter the 'S: Active' state.

6.2.8.1.2 Monitor another PoC Session established (M: Another PoC Session established)

When another PoC Session is established or when a Continuous Media is connected in the previously Discrete Media only PoC Session as specified in the [OMA-PoC-CP] "*PoC Client procedures at PoC Session initialization*" the PoC Client:

1. SHALL create an instance of the general Media Burst operation state machine as specified in 6.2.5 "*PoC Session control state diagram – basic*" or 6.2.9 "*PoC Session control state diagram – queuing*" if queuing of Media Burst requests are used, if MBCP is used;
2. SHALL create an instance of the general Talk Burst operation state machine as specified in [OMA-PoC-1-UP] "*PoC Session control state diagram – basic*" or [OMA-PoC-1-UP] "*PoC Session control state diagram – queuing*" if queuing of Talk Burst requests are used, if TBCP is used; and,
3. SHALL enter the 'S: Dormant' state in case there is an Active PoC Session for the same PoC User.

6.2.8.2 State: 'S: Active'

The 'S: Active' state of a PoC Session containing Continuous Media (one of the Simultaneous PoC Sessions) is a stable state.

In this state the PoC Client is receiving and sending RTP Media packets, TBCP messages and MBCP messages of this PoC Session and monitoring MBCP messages, TBCP messages and SIP requests with associated SDP information of other PoC Sessions containing Continuous Media and is reacting on the events of the PoC Sessions containing Continuous Media, as specified in the following subclauses.

6.2.8.2.1 Send or receive MBCP message (S/R: MBCP)

Upon receiving MBCP Messages the PoC Client:

1. SHALL act as specified in the PoC Session specific state diagrams and state transitions specified in the subclause 6.2.5 "*PoC Session control state diagram – basic*" or 6.2.9 "*PoC Session control state diagram – queuing*" if queuing of Media Burst requests are used; and,
2. SHALL remain in 'S: Active' state.

6.2.8.2.2 Send or receive RTP Media packets (S/R: Media)

When sending or receiving of RTP Media packets for this PoC Session the PoC Client:

1. SHALL act as specified in the PoC Session specific state diagrams and state transitions specified in the subclause 6.2.5 "*PoC Session control state diagram – basic*" or 6.2.9 "*PoC Session control state diagram – queuing*" if queuing of Media Burst requests are used, if MBCP is used;
2. SHALL act as specified in the PoC Session specific state diagrams and state transitions specified in [OMA-PoC-1-UP] "*PoC Session control state diagram – basic*" or in [OMA-PoC-1-UP] "*PoC Session control state diagram – queuing*" if queuing of Talk Burst requests are used, if TBCP is used; and,
3. SHALL remain in 'S: Active' state.

6.2.8.2.3 Monitor PoC Session release when no other PoC Sessions are ongoing (M: Last PoC Session released)

When the PoC Session containing Continuous Media is released or when all Continuous Media are disconnected from the PoC Session and no other PoC Sessions containing Continuous Media for the same PoC Client are ongoing as specified in [OMA-PoC-CP] "*PoC Client setting PoC Session priority*" the PoC Client:

1. SHALL enter the 'Start-stop' state.

6.2.8.2.4 Send SDP with Session LockIn; LockIn indication for the Active PoC Session (S: Session LockIn; Active PoC Session)

Upon receiving an indication from the PoC User that the Active PoC Session is to be locked the PoC Client:

1. SHALL proceed with message handling as specified in [OMA-PoC-CP] "*PoC Client Handling of PoC Session locking*"; and,
2. SHALL remain in 'S: Active' state.

6.2.8.2.5 Send SDP with Session LockIn; LockIn indication for another PoC Session (S: Session LockIn; another PoC Session)

Upon receiving an indication from the PoC User that another PoC Session containing Continuous Media (not the Active PoC Session) is to be locked the PoC Client:

1. SHALL proceed with message handling as specified in [OMA-PoC-CP] "*PoC Client Handling of PoC Session locking*"; and,
2. SHALL enter the 'S: Dormant' state.

6.2.8.2.6 Send SDP with Session UnLock; switch to another PoC Session (S: Session UnLock; another PoC Session)

Upon receiving an indication from the PoC User that this PoC Session is to be unlocked, and if criteria defined in the subclause 7.5.1 "*Procedures at the PoC Client*" for switching to another PoC Session containing Continuous Media are fulfilled then the PoC Client:

1. SHALL proceed with message handling as specified in [OMA-PoC-CP] "*PoC Client Handling of PoC Session locking*"; and,
2. SHALL enter the 'S: Dormant' state.

6.2.8.2.7 Send SDP with Session UnLock; remain active in the current PoC Session (S: Session UnLock; remain in PoC Session)

Upon receiving an indication from the PoC User that this PoC Session is to be unlocked and the PoC Client remains in the current PoC Session (thus the criteria for switching to another PoC Session containing Continuous Media is not fulfilled) then the PoC Client:

1. SHALL proceed with message handling as specified in [OMA-PoC-CP] "*PoC Client Handling of PoC Session locking*"; and,
2. SHALL remain in the 'S: Active' state.

6.2.8.2.8 Monitor SDP with Primary PoC Session established or selected (M: Primary PoC Session established or selected)

Upon receiving of an indication that a Primary PoC Session containing Continuous Media has been established or when a Continuous Media is connected in the previously Discrete Media only Primary PoC Session or should become the Active PoC Session based on new priority settings the PoC Client:

1. SHALL proceed with message handling as specified in [OMA-PoC-CP] "*PoC Client Setting Session priority*" and,
2. if criteria specified in the subclause 7.5.1 "*Procedures at the PoC Client*" for switching to another PoC Session are fulfilled then the PoC Client:
 - a. SHALL enter the 'S: Dormant' state.
3. Otherwise the PoC Client:
 - a. SHALL remain in the 'S: Active' state.

6.2.8.2.9 Receive RTP Media packets (R: Media for another PoC Session)

Upon receiving RTP Media packets for a different PoC Session the PoC Client:

1. SHALL enter the 'S: Dormant' state.

6.2.8.2.10 Send or receive TBCP message (S/R: TBCP)

Upon receiving TBCP Messages the PoC Client:

1. SHALL act as specified in the PoC Session specific state diagrams and state transitions specified in the subclause [OMA-PoC-1-UP] "*PoC Session control state diagram – basic*" or [OMA-PoC-1-UP] "*PoC Session control state diagram – queuing*" if queuing of Talk Burst requests are used; and,
2. SHALL remain in 'S: Active' state.

6.2.8.3 State: 'S: Dormant'

The 'S: Dormant' state of a PoC Session containing Continuous Media is a stable state.

In this state the PoC Client is monitoring MBCP messages, TBCP messages and SIP messages pertaining to this PoC Session and to all other PoC Sessions containing Continuous Media of the same PoC User and is reacting on activation events of the PoC Sessions containing Continuous Media, as specified in the following subclauses.

6.2.8.3.1 Send or receive MBCP message (S/R: MBCP)

Upon receiving MBCP messages (other than the MBCP Media Burst Granted message) or when sending MBCP messages the PoC Client:

1. SHALL act as specified in the PoC Session specific state diagrams and state transitions specified in the subclause 6.2.5 "*PoC Session control state diagram – basic*" or 6.2.9 "*PoC Session control state diagram – queuing*" if queuing of Media Burst requests are used; and,
2. SHALL remain in 'S: Dormant' state.

6.2.8.3.2 Send SDP with Session LockIn for this PoC Session (S: Session LockIn; this PoC Session)

When sending an indication that this PoC Session is to be locked, the PoC Client:

1. SHALL proceed with message handling as specified in [OMA-PoC-CP] "*PoC Client handling PoC Session locking*"; and,
2. SHALL enter the 'S: Active' state.

6.2.8.3.3 Send SDP with Session LockIn for another PoC Session (S: Session LockIn; another PoC Session)

When sending an indication that another PoC Session containing Continuous Media is to be locked, the PoC Client:

1. SHALL proceed with message handling as specified in [OMA-PoC-CP] "*PoC Client handling PoC Session locking*"; and,
2. SHALL remain in the 'S: Dormant' state.

6.2.8.3.4 Send SDP with Primary PoC Session selected; this PoC Session selected (S: Set Primary PoC Session; this PoC Session)

When sending an indication that a PoC Session containing Continuous Media is to be selected as Primary PoC Session and if the Primary PoC Session setting is for this PoC Session and if criteria defined in the subclause 7.5.1 "*Procedures at the PoC Client*" for switching to another PoC Session containing Continuous Media are fulfilled the PoC Client:

1. SHALL proceed with message handling as specified in [OMA-PoC-CP] "*PoC Client setting PoC Session priority*"; and,
2. SHALL enter the 'S: Active' state.

6.2.8.3.5 Send SDP with Primary PoC Session selected; another PoC Session selected or criteria not fulfilled (S: Set Primary PoC Session; another PoC Session or criteria not fulfilled)

When sending an indication that a PoC Session containing Continuous Media is to be selected as Primary PoC Session and if the Primary PoC Session setting is for another PoC Session containing Continuous Media or if criteria defined in the subclause 7.5.1 "*Procedures at the PoC Client*" for switching to another PoC Session containing Continuous Media are not fulfilled the PoC Client:

1. SHALL proceed with message handling as specified in [OMA-PoC-CP] "*PoC Client setting PoC Session priority*"; and,
2. SHALL remain in the 'S: Dormant' state.

6.2.8.3.6 Send SDP with PoC Session UnLock and remain active in another PoC Session (S: Session UnLock; remain dormant)

When sending an indication that another PoC Session containing Continuous Media is to be unlocked and if criteria defined in the subclause 7.5.1 "*Procedures at the PoC Client*" for switching to this PoC Session are not fulfilled, the PoC Client:

1. SHALL proceed with message handling as specified in [OMA-PoC-CP] "*PoC Client handling PoC Session locking*"; and,
2. SHALL remain in the 'S: Dormant' state.

6.2.8.3.7 Send SDP with PoC Session UnLock and switch to this PoC Session (S: Session UnLock; switch to this PoC Session)

When sending an indication that another PoC Session containing Continuous Media is to be unlocked and if criteria defined in the subclause 7.5.1 "*Procedures at the PoC Client*" for switching to this PoC Session are fulfilled, the PoC Client:

1. SHALL proceed with message handling as specified in [OMA-PoC-CP] "*PoC Client handling PoC Session locking*"; and,
2. SHALL enter the 'S: Active' state.

6.2.8.3.8 Monitor PoC Session release and activate this PoC Session (M: PoC Session released; activate this PoC Session)

Upon receiving an indication that another PoC Session containing Continuous Media has been released or when all Continuous Media are disconnected from that PoC Session, and if criteria for activation of this PoC Session defined in the subclause 7.5.1 "*Procedures at the PoC Client*" activation for this PoC Session are fulfilled, then the PoC Client:

1. SHALL enter the 'S: Active' state.

6.2.8.3.9 Monitor PoC Session release and remain active in another PoC Session (M: PoC Session released; remain dormant)

Upon receiving an indication that another PoC Session containing Continuous Media has been released or when all Continuous Media are disconnected from that PoC Session, and if criteria for activation of this PoC Session defined in the subclause 7.5.1 "*Procedures at the PoC Client*" activation for this PoC Session the PoC Client:

1. SHALL remain in the 'S: Dormant' state.

6.2.8.3.10 Receive MBCP Media Burst Granted message (R: MB_Granted)

When receiving a MBCP Media Burst Granted message in a response to a MBCP Media Burst Request the PoC Client:

1. SHALL enter the 'S: Active' state.

6.2.8.3.11 Receive RTP Media packets (R: Media for this PoC Session)

Upon receiving RTP Media packets for this PoC Session the PoC Client:

1. SHALL enter the 'S: Active' state.

6.2.8.3.12 Send or receive TBCP message (S/R: TBCP)

Upon receiving TBCP messages (other than the TBCP Talk Burst Granted message) or when sending TBCP messages the PoC Client:

1. SHALL act as specified in the PoC Session specific state diagrams and state transitions specified in the subclause [OMA-PoC-1-UP] "*PoC Session control state diagram – basic*" or [OMA-PoC-1-UP] "*PoC Session control state diagram – queuing*" if queuing of Talk Burst requests are used; and,
2. SHALL remain in 'S: Dormant' state.

6.2.8.3.13 Receive TBCP Talk Burst Granted message (R: TB_Granted)

When receiving a TBCP Talk Burst Granted message in a response to a TBCP Talk Burst Request the PoC Client:

1. SHALL enter the 'S: Active' state.

6.2.9 PoC Session control state diagram – queuing

NOTE: When the PoC Client negotiates the Talk Burst Control Protocol as specified in [OMA-PoC-1-UP] instead of the Media Burst Control Protocol, the PoC Client acts as specified in [OMA-PoC-1-UP].

If the PoC Client and PoC Server negotiate support of queuing for a PoC Session Media-floor Control Entity, the PoC Client SHALL support the state diagram and the state transitions specified in this subclause.

Figure 7 "*PoC Session control state diagram – queuing*" shows the state diagram for queued operation.

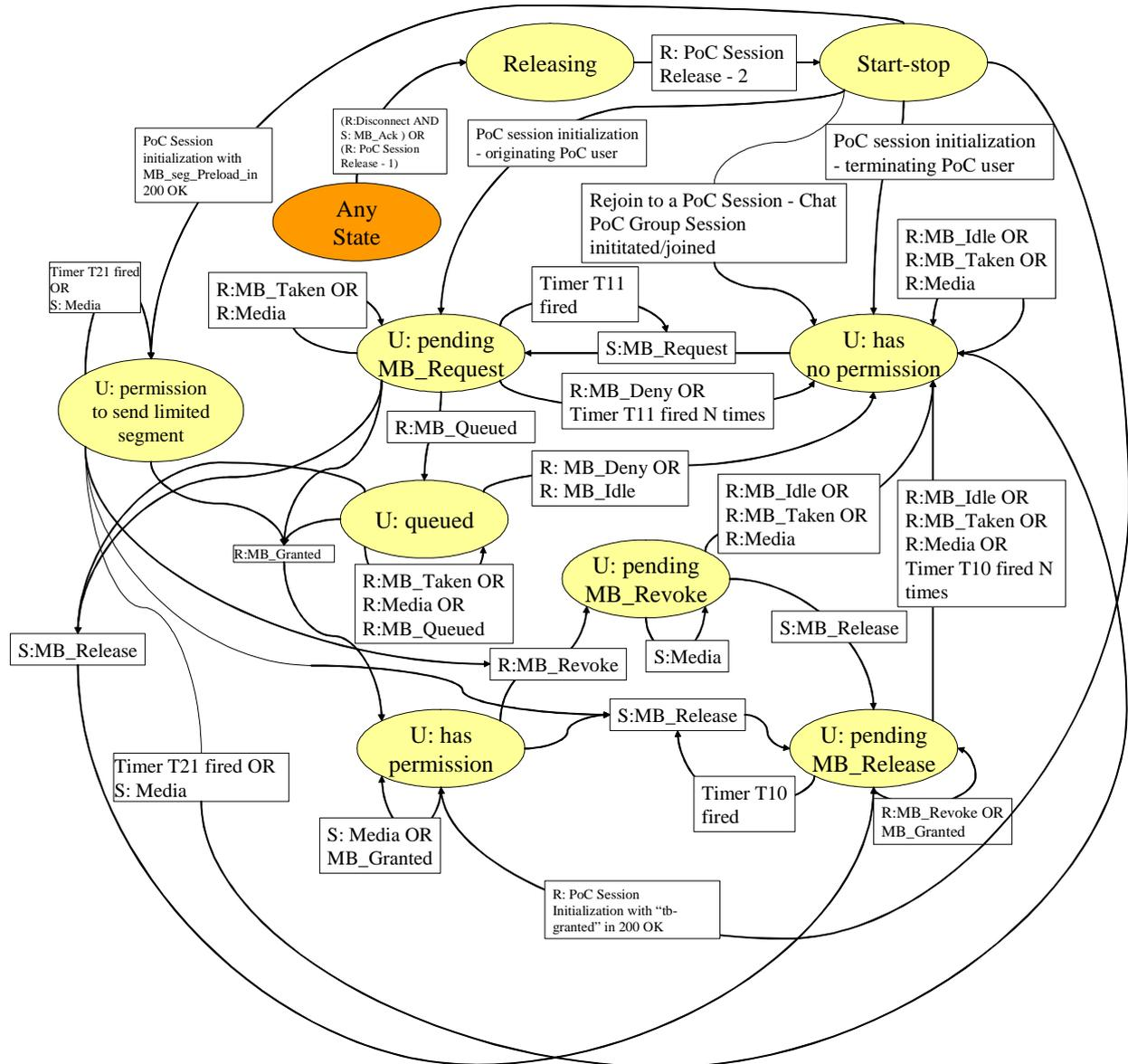

Figure 7: PoC Session control state diagram – queuing

State details are explained in the following subclauses.

If a MBCP message, MSRP request, MSRP response or RTP Media packet arrives in any state and there is no procedure specified for it in the subclauses below the PoC Client SHALL discard the MBCP message, MSRP request, MSRP response or RTP Media packet and SHALL remain in the current state.

6.2.9.1 State: 'Start-stop'

In this state Media-floor Control Entity for queuing does not exist.

Do the actions specified in the subclause 6.2.5.1 "State: 'Start-stop'".

6.2.9.1.1 State: 'U: has no permission'

Do the actions specified in the subclause 6.2.5.2 "State: 'U: has no permission'", but instead of subclause 6.2.5.2.4 "Send MBCP Media Burst Request message (S: MB_Request)" do 6.2.9.2.1 "Send MBCP Media Burst Request message (S: MB_Request)".

6.2.9.1.2 Send MBCP Media Burst Request message (S: MB_Request)

Upon receiving an indication from the PoC User to request permission to send Media the PoC Client:

1. if the PoC Client has a maxpriority = '00 - receive only' the PoC Client:
 - a. SHALL provide an indication to the User that the PoC Client is in receive only mode; and,
 - b. SHALL remain in the 'U: has no permission' state.
2. Otherwise the PoC Client:
 - a. SHALL send the MBCP Media Burst Request message toward the PoC Server;

The MBCP Media Burst Request message:

 - i. MAY include the Media Burst request priority level; and,
 - ii. MAY include the Media Burst request timestamp.
 - b. SHALL start T11 (Media Burst Request) timer; and,
 - c. SHALL enter the 'U: pending MB_Request' state.

6.2.9.2 State: 'U: pending MB_request'

The 'U: pending MB_Request' state is a transition state, and the PoC Client uses this state when the PoC Client is waiting for response to a MBCP Media Burst Request message.

In this state the PoC Client can receive RTP Media packets, MSRP SEND requests and MBCP Media Burst Control messages.

Timer T11 (Media Burst Request) is running in this state.

6.2.9.2.1 Receive MBCP Media Burst Granted message (R: MB_Granted)

Do the actions specified in the subclause 6.2.5.3.1 "Receive MBCP Media Burst Granted message (R: MB_Granted)".

6.2.9.2.2 Receive MBCP Media Burst Taken message (R: MB_Taken)

Upon receiving a MBCP Media Burst Taken message from the PoC Server, the PoC Client:

1. SHALL send a MBCP Media Burst Acknowledgement message if the MBCP Media Burst Taken message expects an acknowledgement reply;
2. SHALL provide Media Burst taken notification to the PoC User;
3. SHOULD perform the mapping between the SSRC of the PoC Client granted a permission to send a Media Burst and the PoC Address or Nick Name or both, if they are included in the message;
4. MAY display the PoC Address or Nick Name or both based on SSRC of the sending PoC Client, if mapping between those exists in PoC Client; and,
5. SHALL remain in the 'U: pending MB_Request' state.

6.2.9.2.3 Receive MBCP Media Burst Deny message (R: MB_Deny)

Do the actions specified in the subclause 6.2.5.3.3 "*Receive MBCP Media Burst Deny message (R: MB_Deny)*".

6.2.9.2.4 T11 (Media Burst request) timer fired

On firing of timer T11 (Media Burst Request), the PoC Client:

1. SHALL send a MBCP Media Burst Request message towards the PoC Server.

The MBCP Media Burst Request message:

- a. MAY include the Media Burst request priority level; and,
 - b. MAY include the Media Burst Request Timestamp of the original Media Burst Request.
2. SHALL remain in the 'U: pending MB_Request' state.

6.2.9.2.5 T11 timer fired N times

Do the actions specified in the subclause 6.2.5.3.5 "*T11 timer fired N times*".

6.2.9.2.6 Receive RTP Media packets (R: Media)

Upon receiving RTP Media packets the PoC Client:

1. SHALL render the Media;
2. MAY display the PoC Address or Nick Name or both based on SSRC of the sending PoC Client, if mapping between those exists in PoC Client; and,
3. SHALL remain in the 'U: pending MB_Request' state.

6.2.9.2.7 Receive MBCP Media Burst Request Queue Status message (R: MB_Queued)

Upon receiving a MBCP Media Burst Request Queue Status message from the PoC Server,

1. if the message indicates that the request has been queued, the PoC Client:
 - a. SHALL provide Media Burst request queued status response notification to the PoC User;
 - b. MAY provide the queue position and priority (if available) to the PoC User;
 - c. SHALL stop T11 (Media Burst Request) timer; and,
 - d. SHALL enter the 'U: queued' state.
2. if the message indicates that the request has not been queued the PoC Client:
 - a. SHALL remain in the 'U: pending MB_Request' state.

6.2.9.2.8 Receiving a MSRP SEND request (R: MSRP SEND)

Upon receiving an MSRP SEND request the PoC Client:

1. SHALL generate and send a MSRP 200 "OK" response according to rules and procedures of [OMA-PoC-IM];
2. MAY render the received content of the MSRP SEND request for the PoC User;
3. MAY display the PoC Address or Nick Name or both retrieved from the message/cpim From header in the MSRP SEND body; and,
4. SHALL enter the 'U: pending MB_Request' state.

6.2.9.3 State: 'U: has permission'

Do the actions specified in this subclause and the actions specified in the subclause 6.2.5.4 "*State: 'U: has permission'*".

NOTE: If the PoC Client was queued, the PoC Client can request a confirmation from the PoC User before starting sending the Media. If confirmed, the Media sending starts otherwise the permission to send Media is released.

6.2.9.3.1 Receive MB CP Media Burst Granted message (R: MB_Granted)

Upon receiving a MB CP Media Burst Granted message from the PoC Server, the PoC Client:

1. SHALL remain in the 'U: has permission' state.

6.2.9.4 State: 'U: pending MB_Release'

Do the actions specified in this subclause and the actions specified in the subclause 6.2.5.5 "*State: 'U: pending MB_Release'*".

6.2.9.4.1 Receive MB CP Media Burst Granted message (R: MB_Granted)

Upon receiving a MB CP Media Burst Granted message from the PoC Server, the PoC Client:

1. SHALL remain in the 'U: pending MB_Release' state.

6.2.9.5 State: 'U: pending MB_Revoke'

Do the actions specified in the subclause 6.2.5.6 "*State: 'U: pending MB_Revoke'*".

6.2.9.6 State: 'U: Queued'

The 'U: queued' state is a stable state and the PoC Client uses this state when the PoC Client has received indication from the PoC Server that a request to send a Media Burst has been queued by the PoC Server, and is awaiting indication that a Media Burst has been granted. In this state the PoC Client can receive RTP Media packets and can send and receive MB CP Media Burst Control messages.

6.2.9.6.1 Receive RTP Media packets (R: Media)

Upon receiving RTP Media packets the PoC Client:

1. SHALL render the Media;
2. MAY display the PoC Address or Nick Name or both based on SSRC of the sending PoC Client, if mapping between those exists in PoC Client;
3. SHOULD restart the T13 (end of RTP Media) timer; and,
4. SHALL remain in the 'U: Queued' state.

6.2.9.6.2 Receive MB CP Media Burst Taken message (R: MB_Taken)

Upon receiving a MB CP Media Burst Taken message from the PoC Server, the PoC Client:

1. SHOULD perform the mapping between the SSRC of the PoC Client granted a permission to send a Media Burst and the PoC Address or Nick Name or both, if they are included in the message;
2. MAY display the PoC Address and Nick Name to the PoC User, if they are included in the message, or alternatively if the PoC Client has a mapping between SSRC of the PoC Client granted a permission to send a Media Burst and the PoC Address and /or Nick Name;
3. SHALL provide Media Burst taken notification to the PoC User; and,
4. SHALL remain in the 'U: Queued' state.

6.2.9.6.3 Receive MBCP Media Burst Granted message (R: MB_Granted)

Upon receiving a MBCP Media Burst Granted message from the PoC Server, the PoC Client:

2. SHALL provide Media Burst granted notification to the PoC User;
3. MAY provide information about the stop talking timer value to the PoC User;
4. MAY provide notification of the number of Participants, receiving the Media Burst, to the PoC User, if included in the message; and,
5. SHALL enter the 'U: has permission' state.

6.2.9.6.4 Receive MBCP Media Burst Deny message (R: MB_Deny)

Upon receiving a MBCP Media Burst Deny message from the PoC Server, the PoC Client:

1. SHALL provide Media Burst deny notification to the PoC User;
2. MAY display the Media Burst Deny reason, if it is included in the message; and,
3. SHALL enter the 'U: has no permission' state.

6.2.9.6.5 Send MBCP Media Burst Release message (S: MB_Release)

Upon receiving an indication to release the queued Media Burst request from the PoC User, the PoC Client:

1. SHALL send a MBCP Media Burst Release message towards the PoC Server.

The MBCP Media Burst Release message:

- a. SHALL include the sequence number ignore field set to 1.
2. SHALL start timer T10 (Media Burst Release); and,
3. SHALL enter the 'U: pending MB_Release' state.

6.2.9.6.6 Receive MBCP Media Burst Request Queue Status message (R: MB_Queued)

Upon receiving a MBCP Media Burst Request Queue Status message from the PoC Server, the PoC Client:

1. if the message indicates that the request has been queued, the PoC Client:
 - a. MAY provide the queue position and priority (if available) to the PoC User;
2. SHALL remain in the 'U: queued' state.

6.2.9.6.7 Receive MBCP Media Burst Idle message (R: MB_Idle)

Upon receiving a MBCP Media Burst Idle message from the PoC Server, the PoC Client:

1. SHALL enter the 'U: has no permission' state.

6.2.9.7 State: Any state

This subclause describes the actions to be taken in all states defined for the queuing state diagram with the exception of the 'Start-stop' state.

6.2.9.7.1 Receive MBCP Disconnect message (R: Disconnect)

Do the actions specified in the subclause 6.2.5.7.1 "*Receive MBCP Disconnect message (R: Disconnect)*".

6.2.9.7.2 Receive PoC Session release - 1 (R: PoC Session release - 1)

Do the actions specified in the subclause 6.2.5.7.2 "*Receive PoC Session release - 1*".

6.2.9.8 State: Releasing

Do the actions specified in the subclause 6.2.5.8 "*State: Releasing*".

6.2.9.9 State: 'U: Permission to send limited segment'

Do the actions specified in the subclause 6.2.5.9 "*State: U: Permission to send limited segment*".

6.2.10 PoC Client procedures for Media Stream not bound to Media-floor Control Entity

NOTE: The Discrete Media can also be received as specified in [OMA-PoC-CP] "*PoC Client receiving Discrete Media as a SIP MESSAGE*" and sent as specified in [OMA-PoC-CP] "*PoC Client sending a Discrete Media as a SIP MESSAGE*".

6.2.10.1 Receiving a MSRP SEND request

Upon receiving an MSRP SEND request the PoC Client:

1. SHALL generate and send a MSRP 200 "OK" response according to rules and procedures of [OMA-PoC-IM];
2. MAY store the received content of the MSRP SEND request; and,
3. MAY notify the PoC User that Discrete Media is received.

6.2.10.2 Sending a MSRP SEND request

When Discrete Media is available for transfer, the PoC Client:

1. SHALL generate a MSRP SEND request according to rules and procedures of [OMA-PoC-IM];
2. SHALL include the encoded Discrete Media as specified in [OMA-PoC-IM]; and,
3. SHALL send the MSRP SEND request according to rules and procedures of [OMA-PoC-IM].

6.3 Procedures at the PoC Server performing the Participating PoC Function

6.3.1 General

The PoC Server SHALL support the basic procedures specified in the subclause 6.3.5 "*PoC Session Procedures – Basic*" if the PoC Server stays in the Media path.

The PoC Server MAY support the Pre-established Session procedure as specified in subclause 6.3.6 "*Pre-established Session state diagrams – basic*".

The PoC Server MAY support the Simultaneous PoC Session procedure as specified in the subclause 6.3.7 "*Simultaneous PoC Sessions state diagram - per PoC Client*" and 6.3.8 "*Simultaneous PoC Sessions state diagram - per PoC Session*".

If the PoC Server supports Simultaneous PoC Sessions also procedures described in [OMA-PoC-1-UP] SHALL be used when the PoC Session is a PoC 1 session.

6.3.2 Participating PoC Function procedures at PoC Session initialization

There are two types of PoC Sessions where the PoC Server needs to initiate procedures in the User Plane:

1. The PoC Session is an On-demand Session and the PoC Server remains in the transport path; or,
2. The PoC Session is using a Pre-established Session.

If the PoC Server and PoC Client support Simultaneous PoC Sessions, the PoC Session can be one of many Simultaneous PoC Sessions that the PoC Server is managing for a given PoC Client. When the first PoC Session with Continuous Media is established, the procedures specified in subclause 6.2.7 "*Simultaneous PoC Sessions state diagram – per PoC Client*" are performed.

If the PoC Session is either an On-demand Session or a PoC Session using a Pre-established Session, if the PoC Server does not support Simultaneous PoC Sessions, the procedures in subclause 6.3.5 "*PoC Session Procedure –basic*" is performed.

If the PoC Session in case of manual answer using Pre-established Session is established, the PoC Server performing the Participating PoC Function sends the MBCP Connect message to the Invited PoC Client as specified in subclause 6.3.6.2.4 "*Receive SIP 200 "OK" response to the SIP re-INVITE request (R: 200 OK)*".

Before the PoC Server sends the first Media Burst Control Protocol message in the PoC Session, the PoC Server has to assign itself a SSRC identifier to be included in the Media Burst Control Protocol messages. A suitable algorithm to generate the SSRC identifier is described in [RFC3550].

6.3.3 Participating PoC Function procedures at PoC Session release

When a PoC Session is released (whether it is initiated by the PoC Client or PoC Server) and the PoC Server remained on the transport path, a two-stage procedure is followed:

1. In the first stage, the PoC Server stops forwarding all MBCP messages, RTP Media packets and RTCP packets and relaying MSRP requests and responses between the PoC Client and the PoC Server performing the Controlling PoC Function.
2. In the second stage, the PoC Server terminates any processes or state machines on the User Plane associated with this PoC Session.

There are no cases where a User Plane state machine will cause the PoC Session to be released.

If Simultaneous PoC Sessions are supported and the released PoC Session included Continuous Media:

1. The 'Simultaneous PoC Sessions state machine – per PoC Client' associated with the PoC Session being released is terminated; and,
2. if the last PoC Session with Continuous Media is being released, the 'Simultaneous PoC Sessions state machine – per PoC Session' is terminated.

If the PoC Session uses a Pre-established Session, the Pre-established Session state machine returns to a state specified in subclause 6.3.6 "*Pre-established Session state diagrams – basic*".

If a Pre-established Session is released, the Pre-established Session state machine is terminated.

6.3.3A Participating PoC Function procedures at PoC Session modification

6.3.3A.1 Participating PoC Function procedures when connecting to a Media Type

If connecting to Continuous Media is agreed, the PoC Server includes the Media Type in the filtering process and creates the 'Simultaneous PoC Sessions state diagram - per PoC Client' as specified in the subclause 6.3.7 "*Simultaneous PoC Sessions state diagram - per PoC Client*", if not already started and if more than one PoC Session per PoC Client includes the Continuous Media.

NOTE: When a Continuous Media is connected, the Simultaneous PoC Sessions state machine is created and started in a special case, when the PoC Client has e.g. two PoC Sessions: one having only Discrete Media and another one having PoC Speech and when PoC User adds PoC Speech to the first PoC Session.

When a new Media-floor Control Entity is agreed, the PoC Server starts handling the Media-floor Control Entity messages.

6.3.3A.2 Participating PoC Function procedures when disconnecting from a Media Type

If disconnecting from a Media Type is agreed, the PoC Server stops handling the Media Type and remove the 'Simultaneous PoC Sessions state diagram - per PoC Client' as specified in the subclause 6.3.7 "*Simultaneous PoC Sessions state diagram - per PoC Client*", if not more than one PoC Session per PoC Client includes anymore the Continuous Media.

When removing of an existing Media-floor Control Entity is agreed, the PoC Server stops handling the Media-floor Control Entity messages.

6.3.4 Participating PoC Function procedures at Pre-established Session release

The User Plane resources for a Pre-established Session are released after the Control Plane has released the Pre-established Session. This means that any PoC Session over the Pre-established Session has been released before the Pre-established Session is released and so, there are no RTP Media packets MBCP messages, MSRP requests or responses flowing at the time that the Pre-established Session is released. All that the PoC Server needs to do is to release any User Plane resources associated with the Pre-established Session.

6.3.5 PoC Session Procedures – basic

NOTE 1: When the PoC Server negotiates with the PoC Client the Talk Burst Control Protocol as specified in [OMA-PoC-1-UP] instead of the Media Burst Control Protocol, the PoC Server acts as specified in [OMA-PoC-1-UP].

When a PoC Session is initiated and the PoC Server remains on the transport path, a process SHALL be created that

1. SHALL forward all MBCP messages from the PoC Client to the PoC Server performing the Controlling PoC Function at the address and port as specified during PoC Session setup. See [OMA-PoC-CP] "*Participating PoC Function procedures*";
2. SHALL forward all MBCP messages from the PoC Server performing the Controlling PoC Function to the PoC Client at the address and port as specified during PoC Session setup. See [OMA-PoC-CP] "*Participating PoC Function procedures*";
3. SHALL forward all RTP Media packets with payload of each used Continuous Media from the PoC Client to the PoC Server performing the Controlling PoC Function at the address and port as specified during PoC Session setup. See [OMA-PoC-CP] "*Participating PoC Function procedures*";
4. SHALL, if PoC Media Traffic Optimisation has not been negotiated, forward all RTP Media packets of each used Continuous Media from the PoC Server performing the Controlling PoC Function to the PoC Client at the address and port as specified during PoC Session setup. See [OMA-PoC-CP] "*Participating PoC Function procedures*";
5. SHALL, if PoC Media Traffic Optimisation has been negotiated, forward RTP Media packets of each used Continuous Media from the PoC Server performing the Controlling PoC Function to PoC Clients satisfying the following conditions:
 - a. The PoC Clients Media are set off hold;
 - b. The RTP Media packets are not originating from the PoC Client itself; and,
 - c. The PoC Client's Media Parameters are the same as the received RTP Media packets' parameters.

NOTE 2: PoC Media Traffic Optimisation does not cover Discrete Media and cannot be negotiated for PoC Session, in which the 1-many-1 communication method is used.

NOTE 3: The handling of RTCP packets is explained in the subclause 5.4 "RTCP".

6. SHALL relay MSRP requests and responses of each used Discrete Media from the PoC Client to the PoC Server performing the Controlling PoC Function as specified in [OMA-IM-TS] and as endorsed in [OMA-PoC-IM]; and,
7. SHALL relay MSRP requests and responses of each used Discrete Media from the PoC Server performing the Controlling PoC Function to the PoC Client at the address and port as specified during PoC Session setup as specified in [OMA-IM-TS] and as endorsed in [OMA-PoC-IM].

6.3.6 Pre-established Session state diagrams – basic

If the PoC Server supports Pre-established Session the PoC Server SHALL support the state diagram and the state transitions specified in this subclause.

Pre-established Session has three states: 'Pre-established Session_Not_In_Use' state, Pre-established Session_In_use' state and 'PoC Session Releasing' state. The states are partly controlled by the Control Plane as specified in [OMA-PoC-CP].

Figure 8 "*Pre-established Session state diagrams – basic*" shows the general Pre-established Session states (G states) and the state transitions.

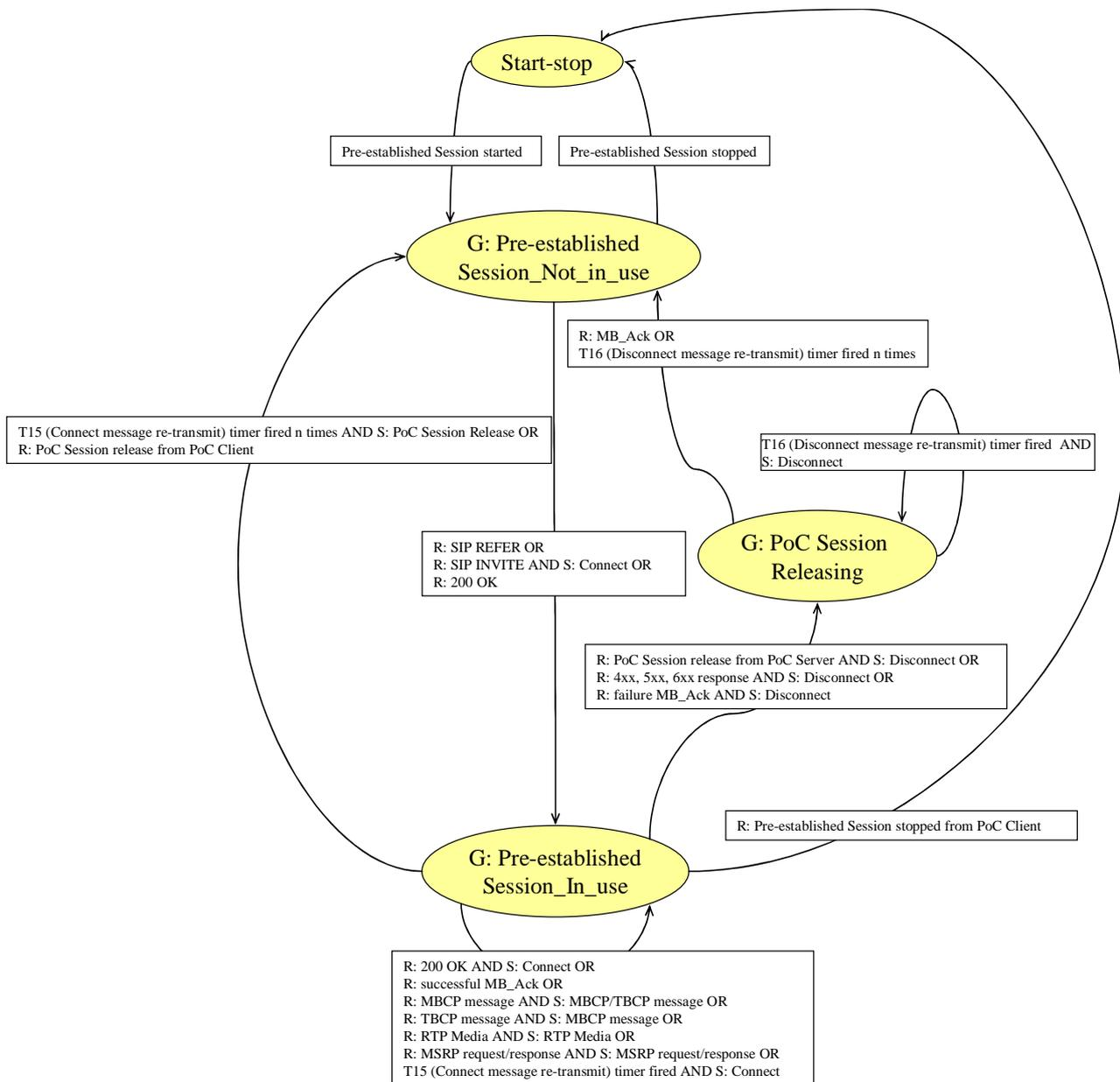

NOTE: T15 is the 'Connect message re-transmit' timer and T 16 is the 'Disconnect message re-transmit' timer.

Figure 8: Pre-established Session state diagrams – basic

The PoC Server SHALL create one instance of the Pre-established Session state machine per Pre-established Session initiated by PoC Client.

State details are explained in the following subclauses.

If a MBCP message, TBCP message, SIP request, SIP response, RTP Media packet, MSRP request or response arrives in any state and there is no procedure specified for it in the subclauses below the PoC Server SHALL discard the MBCP message, TBCP message, SIP request, SIP response RTP Media packet, MSRP request or response and SHALL remain in the current state.

6.3.6.1 State 'Start-stop'

In this state, no Pre-established Session exists.

6.3.6.1.1 Pre-established Session started

When a Pre-established Session is created between the PoC Server and a PoC Client, the PoC Server:

1. SHALL initialize any needed User Plane resources for the Pre-established Session; and,
2. SHALL enter the 'G: Pre-established Session_Not_in_use' state.

6.3.6.2 State 'G: Pre-established Session_Not_in_use'

The 'G: Pre-established Session_Not_in_use' state is a stable state. The PoC Server Function is in this state when the Pre-established Session is established, but it is not used for a PoC Session.

In this state the PoC Server can receive PoC Session initiation.

6.3.6.2.1 Receive SIP REFER request (R: SIP REFER)

Upon receiving a SIP REFER request from the PoC Client the PoC Server:

1. SHALL reserve the User Plane resources for the PoC Session, if not yet reserved; and,
2. SHALL enter the 'G: Pre-established Session_In_use' state.

6.3.6.2.2 Receive SIP INVITE request (R: SIP INVITE)

Upon receiving a SIP INVITE request from the PoC Server performing the Controlling PoC Function the PoC Server:

1. if Automatic Answer Mode is used the PoC Server:
 - a. SHALL send the MBCP Connect message to the Invited PoC Client using the UDP port of one of the Media-floor Control Entities used in the PoC Session.

The MBCP Connect message:

- i. SHALL include the CNAME to identify the PoC Session Identity;
- ii. SHALL include the CNAME to identify the PoC Client initiating the PoC Session, if privacy was not requested;
- iii. MAY include the NAME to identify the Nick Name of the PoC Client initiating the PoC Session;
- iv. SHALL include the CNAME of the PoC Group Identity, if this is a Pre-arranged or Chat PoC Group Session;
- v. MAY include the NAME to identify the PoC Group Name, if this is a Pre-arranged or Chat PoC Group Session
- vi. MAY include the NAME and CNAME to identify the Nick Name and the PoC Address of each non-anonymous Invited PoC User;
- vii. If this is a Dispatch PoC Session the MBCP Connect message:
 - a) SHALL include dispatcher (b-bit) set to 1;
 - b) SHALL include in the role (c-bit) set to 1 if the PoC User is invited as PoC Dispatcher otherwise set to 0;
 - c) SHALL include the type (d-bit) of Dispatch PoC Session;

- viii. SHALL include the MBCP-restrict field with the MBCP-restrict-value set to 1, if the Media-floor Control Entity of the PoC Session associated with the Pre-established Session does not use the Media-floor Control Protocol multimedia extensions as specified in [OMA-PoC-CP] "*Media Burst Control Protocol MIME registration*";
 - ix. SHALL include the Media-Streams field indicating the usage of the Media Streams of the Pre-established Session in the associated PoC Session, if a Media Stream of the Pre-established Session does not have a matching Media Stream in the PoC Session; and,
 - x. SHALL include the Discrete-Media-feature-tag-indication with the value set to 1 if the '+g.poc.discretemedia' feature tag was included in the SIP INVITE request.
- b. SHALL start the T15 (Connect message re-transmit) timer;
 - c. SHALL reserve the User Plane resources for the PoC Session, if not yet reserved;
- 2. SHALL enter the 'G: Pre-established Session_In_use' state.

NOTE: In case manual answer is used the procedure is described in [OMA-PoC-CP] "*Manual-Answer*".

6.3.6.2.3 Pre-established Session stopped

When the Pre-established Session between the PoC Client and the PoC Server is released, the PoC Server:

- 1. SHALL release any User Plane resources including any running timers associated with the Pre-established Session; and,
- 2. SHALL enter the 'Start-stop' state.

6.3.6.2.4 Receive SIP 200 "OK" response to the SIP re-INVITE request (R: 200 OK)

Upon receiving the SIP 200 "OK" response to the SIP re-INVITE request of the Pre-established Session initiating a PoC Session as specified in the [OMA-PoC-CP] "*Manual-answer using Pre-established Session*", the PoC Server:

- 1. SHALL send the MBCP Connect message to the Invited PoC Client using the UDP port of one of the Media-floor Control Entities used in the PoC Session.

The MBCP Connect message:

- a. SHALL include the CNAME to identify the PoC Session Identity;
- b. SHALL include the CNAME to identify the PoC Client initiating the PoC Session, if privacy was not requested;
- c. MAY include the NAME to identify the Nick Name of the PoC Client initiating the PoC Session;
- d. SHALL include the CNAME of the PoC Group Identity, if this is a Pre-arranged or Chat PoC Group Session;
- e. MAY include the NAME to identify the PoC Group Name, if this is a Pre-arranged or Chat PoC Group Session;
- f. MAY include the NAME and CNAME to identify the Nick Name and the PoC Address of each non-anonymous Invited PoC User;
- g. If this is a Dispatch PoC Session the MBCP Connect message:
 - i. SHALL include dispatcher (b-bit) set to 1;
 - ii. SHALL include in the role (c-bit) set to 1 if the PoC User is invited as PoC Dispatcher otherwise set to 0;

- iii. SHALL include the type (d-bit) of Dispatch PoC Session;
 - h. SHALL include the MBCP-restrict field with the MBCP-restrict-value set to 1, if the Media-floor Control Entity of the PoC Session associated with the Pre-established Session does not use the Media-floor Control Protocol multimedia extensions as specified in [OMA-PoC-CP] "*Media Burst Control Protocol MIME registration*"; and,
 - i. SHALL include the Media-Streams field indicating the usage of the Media Streams of the Pre-established Session in the associated PoC Session, if a Media Stream of the Pre-established Session does not have a matching Media Stream in the PoC Session.
2. SHALL start the T15 (Connect message re-transmit) timer;
 3. SHALL reserve the User Plane resources for the PoC Session, if not yet reserved and,
 4. SHALL enter the 'G: Pre-established Session_In_use' state.

6.3.6.3 State 'G: Pre-established Session_In_use'

The 'G: Pre-established Session_In_use' state is a stable state. The PoC Server is in this state when a Pre-established Session is established and it is used for a PoC Session.

In this state the PoC Server can receive RTP Media packets, TBCP message, MBCP messages and MSRP request or response.

6.3.6.3.1 Receive MBCP message (R: MBCP message)

Upon receiving a MBCP message the PoC Server:

1. SHALL forward the MBCP message between the PoC Client and the PoC Server performing the Controlling PoC Function, if the Media-floor Control Entity of the PoC Session associated with the Pre-established Session uses the Media-floor Control Protocol multimedia extensions as specified in [OMA-PoC-CP] "*Media Burst Control Protocol MIME registration*";
2. SHALL create a TBCP message of the same subtype as the MBCP message and include into the TBCP message the allowed received MBCP message specific fields and send the TBCP message to the PoC Server performing the Controlling PoC Function, if the MBCP message is received from the PoC Client and if the Media-floor Control Entity of the PoC Session associated with the Pre-established Session does not use the Media-floor Control Protocol multimedia extensions as specified in [OMA-PoC-CP] "*Media Burst Control Protocol MIME registration*"; and,
3. SHALL remain in the 'Pre-established Session_In_use' state.

6.3.6.3.2 Receive RTP Media packets (R: RTP Media)

Upon receiving RTP Media packets the PoC Server:

1. SHALL forward the RTP Media packets of a used Media Type between the PoC Client and the PoC Server performing the Controlling PoC Function; and,
2. SHALL remain in the 'Pre-established Session_In_use' state.

6.3.6.3.3 Receive PoC Session release indication from PoC Client (R: PoC Session release from PoC Client)

Upon receiving an indication that the PoC Session is released, but the Pre-established Session is kept alive the PoC Server:

1. SHALL send PoC Session release to the Controlling PoC Function as specified in [OMA-PoC-CP] "*PoC Session release from User Plane*";
2. MAY release any User Plane resources associated with the PoC Session not needed for the Pre-established Session;

3. SHALL stop the T15 (Connect message re-transmit) timer, if running; and,
4. SHALL enter the 'G: Pre-established Session_Not_in_use' state.

6.3.6.3.4 Receive PoC Session release indication from Controlling PoC Function (R: PoC Session release from PoC Server)

Upon receiving an indication from the PoC Server performing the Controlling PoC Function that the PoC Session is released, the PoC Server:

1. SHALL stop the T15 (Connect message re-transmit) timer, if running;
2. SHALL send a MBCP Disconnect message to the PoC Client;
3. SHALL start the T16 (Disconnect message re-transmit) timer; and,
4. SHALL enter the 'G: PoC Session Releasing' state.

6.3.6.3.5 Receive Pre-established Session stopped indication from PoC Client (R: Pre-established Session stopped from PoC Client)

Upon receiving the Pre-established Session release from the PoC Client , the PoC Server:

1. SHALL stop sending RTP Media packets, TBCP messages and MBCP messages and relaying of MSRP requests and responses between the PoC Client and the PoC Server performing the Controlling PoC Function;
2. SHALL release any User Plane resources including any running timers associated with the PoC Session and the Pre-established Sessions; and,
3. SHALL enter the 'Start-stop' state.

6.3.6.3.6 Receive MBCP Media Burst Acknowledgement message ((R: successful MB_Ack) and (R: failure MB_Ack))

Upon receiving a MBCP Media Burst Acknowledgement message from the PoC Client, the PoC Server:

1. SHALL stop the T15 (Connect message re-transmit) timer; and,
2. if the reason code is not 'Accepted' the PoC Server:
 - a. SHALL send MBCP Disconnect message to the PoC Client;
 - b. SHALL start the T16 (Disconnect message re-transmit) timer;
 - c. SHALL send a PoC Session release to the Controlling PoC Function as specified in [OMA-PoC-CP] "*PoC Session release from User Plane*"; and,
 - d. SHALL enter the 'G: Releasing' state.
3. Otherwise the PoC Server:
 - a. SHALL remain in the 'G: Pre-established Session_In_use' state.

6.3.6.3.7 T15 (Connect message re-transmit) timer fired

On expiry of T15 (Connect message re-transmit) timer, the PoC Server:

1. SHALL send a MBCP Connect message to the PoC Client using the UDP port of one of the Media-floor Control Entities used in the PoC Session.

The MBCP Connect message:

- a. SHALL include the CNAME to identify the PoC Session Identity;
 - b. SHALL include the CNAME to identify the PoC Client initiating the PoC Session, if privacy was not requested;
 - c. MAY include the NAME to identify the Nick Name of the PoC Client initiating the PoC Session;
 - d. SHALL include the CNAME of the PoC Group Identity, if this is a Pre-arranged or Chat PoC Group Session;
 - e. MAY include the NAME to identify the PoC Group Name, if this is a Pre-arranged or Chat PoC Group Session;
 - f. SHALL include the MBCP-restrict field with the MBCP-restrict-value set to 1, if the Media-floor Control Entity of the PoC Session associated with the Pre-established Session does not use the Media-floor Control Protocol multimedia extensions as specified in [OMA-PoC-CP] "*Media Burst Control Protocol MIME registration*";
 - g. SHALL include the Media-Streams field indicating the usage of the Media Streams of the Pre-established Session in the associated PoC Session, if a Media Stream of the Pre-established Session does not have a matching Media Stream in the PoC Session; and,
 - h. SHALL include the Discrete-Media-feature-tag-indication with the value set to 1 if the '+g.poc.discretedia' feature tag was included in the SIP INVITE request received from the PoC Server performing the Controlling PoC Function.
2. SHALL restart the T15 (Connect message re-transmit) timer; and,
 3. SHALL remain in the 'G: Pre-established Session_In_use' state.

6.3.6.3.8 T15 (Connect message re-transmit) timer fired N times

On the N:th firing of timer T15 (Connect message re-transmit), the PoC Server:

1. SHALL send a PoC Session release to the Controlling PoC Function as specified in [OMA-PoC-CP] "*PoC Session release from User Plane*";
2. MAY release any User Plane resources associated with the PoC Session not needed for the Pre-established Session; and,
3. SHALL enter the 'G: Pre-established Session_Not_in_use' state.

6.3.6.3.9 Receive SIP 200 "OK" response (R: SIP 200 OK)

Upon receiving a SIP 200 "OK" response from the PoC Server performing the Controlling PoC Function the PoC Server:

1. SHALL send the MBCP Connect message to the PoC Client, which initiated a PoC Session using the UDP port of one of the Media-floor Control Entities used in the PoC Session.

The MBCP Connect message:

- a. SHALL include the CNAME to identify the PoC Session Identity;
- b. SHALL include the CNAME to identify the PoC Client initiating the PoC Session, if privacy was not requested;
- c. MAY include the NAME to identify the Nick Name of the PoC Client initiating the PoC Session;
- d. SHALL include the CNAME of the PoC Group Identity, if this is a Pre-arranged or Chat PoC Group Session;
- e. MAY include the NAME to identify the PoC Group Name, if this is a Pre-arranged or Chat PoC Group Session;

- f. SHALL include the MBCP-restrict field with the MBCP-restrict-value set to 1, if the Media-floor Control Entity of the PoC Session associated with the Pre-established Session does not use the Media-floor Control Protocol multimedia extensions as specified in [OMA-PoC-CP] "*Media Burst Control Protocol MIME registration*"; and,
 - g. SHALL include the Media-Streams field indicating the usage of the Media Streams of the Pre-established Session in the associated PoC Session, if a Media Stream of the Pre-established Session does not have a matching Media Stream in the PoC Session.
2. SHALL start the T15 (Connect message re-transmit) timer; and,
 3. SHALL remain in the 'G: Pre-established Session_In_use' state.

6.3.6.3.10 Receives a failed SIP response from the Controlling PoC Function (R: PoC Session release from PoC Server)

Upon receiving a failed PoC Session establishment indication from the PoC Server performing the Controlling PoC Function, the PoC Server:

1. SHALL send a MBCP Disconnect message to the PoC Client;
2. SHALL start the T16 (Disconnect message re-transmit) timer;
3. SHALL terminate the PoC Session; and,
4. SHALL enter the 'G: PoC Session Releasing' state.

6.3.6.3.11 Receive MSRP request or response (R: MSRP request/response)

Upon receiving MSRP request or response the PoC Server:

1. SHALL forward the MSRP request or response between the PoC Client and the PoC Server performing the Controlling PoC Function; and,
2. SHALL remain in the 'Pre-established Session_In_use' state.

6.3.6.3.12 Receive TBCP message (R: TBCP message)

Upon receiving a TBCP message the PoC Server:

1. SHALL create a MBCP message of the same subtype as the TBCP message and include into the MBCP message the allowed received TBCP message specific fields and send the MBCP message to the PoC Client, if the MBCP message is received from the PoC Server performing the Controlling PoC Function and if the Media-floor Control Entity of the PoC Session associated with the Pre-established Session does not use the Media-floor Control Protocol multimedia extensions as specified in [OMA-PoC-CP] "*Media Burst Control Protocol MIME registration*"; and,
2. SHALL remain in the 'Pre-established Session_In_use' state.

6.3.6.4 State 'G: PoC Session Releasing'

The 'G: PoC Session Releasing' state is a transition state. The PoC Server is in this state when a PoC Server originated PoC Session is releasing.

The T16 (Disconnect message re-transmit) timer is running in this state.

6.3.6.4.1 Receive MBCP Media Burst Acknowledgement message (R: MB_Ack)

Upon receiving a MBCP Media Burst Acknowledgement message from the PoC Client, the PoC Server:

1. SHALL stop the T16 (Disconnect message re-transmit) timer;
2. SHALL stop T15 (Connect message re-transmit), if running;

3. MAY release any User Plane resources associated with the PoC Session not needed for the Pre-established Session; and,
4. SHALL enter the 'G: Pre-established Session_Not_in_use' state.

6.3.6.4.2 T16 (Disconnect message re-transmit) timer fired

On expiry of T16 (Disconnect message re-transmit) timer, the PoC Server:

1. SHALL send a MBTCP Disconnect message to the PoC Client;
2. SHALL restart the T16 (Disconnect message re-transmit) timer; and,
3. SHALL remain in the 'G: PoC Session Releasing' state.

6.3.6.4.3 T16 timer fired N times

On the N:th firing of timer T16 (Disconnect message re-transmit), the PoC Server:

1. SHALL stop the T16 (Disconnect message re-transmit) timer;
2. MAY release any User Plane resources associated with the PoC Session not needed for the Pre-established Session; and,
3. SHALL enter the 'G: Pre-established Session_Not_in_use' state.

6.3.7 Simultaneous PoC Sessions state diagram - per PoC Client

If the PoC Server supports Simultaneous PoC Sessions the PoC Server SHALL support the state diagram and the state transitions specified in this subclause, when PoC Client has more than one PoC Session including the Continuous Media.

The PoC Server SHALL determine the PoC Sessions used by the PoC Client as specified in subclause [OMA-POC-CP] "*PoC Session association*".

The state diagram SHALL be used for PoC Sessions established as specified in [OMA-PoC-1-UP].

Figure 9 "*Simultaneous PoC Sessions state diagram - per PoC Client*" shows the state diagram for Simultaneous PoC Session per PoC Client.

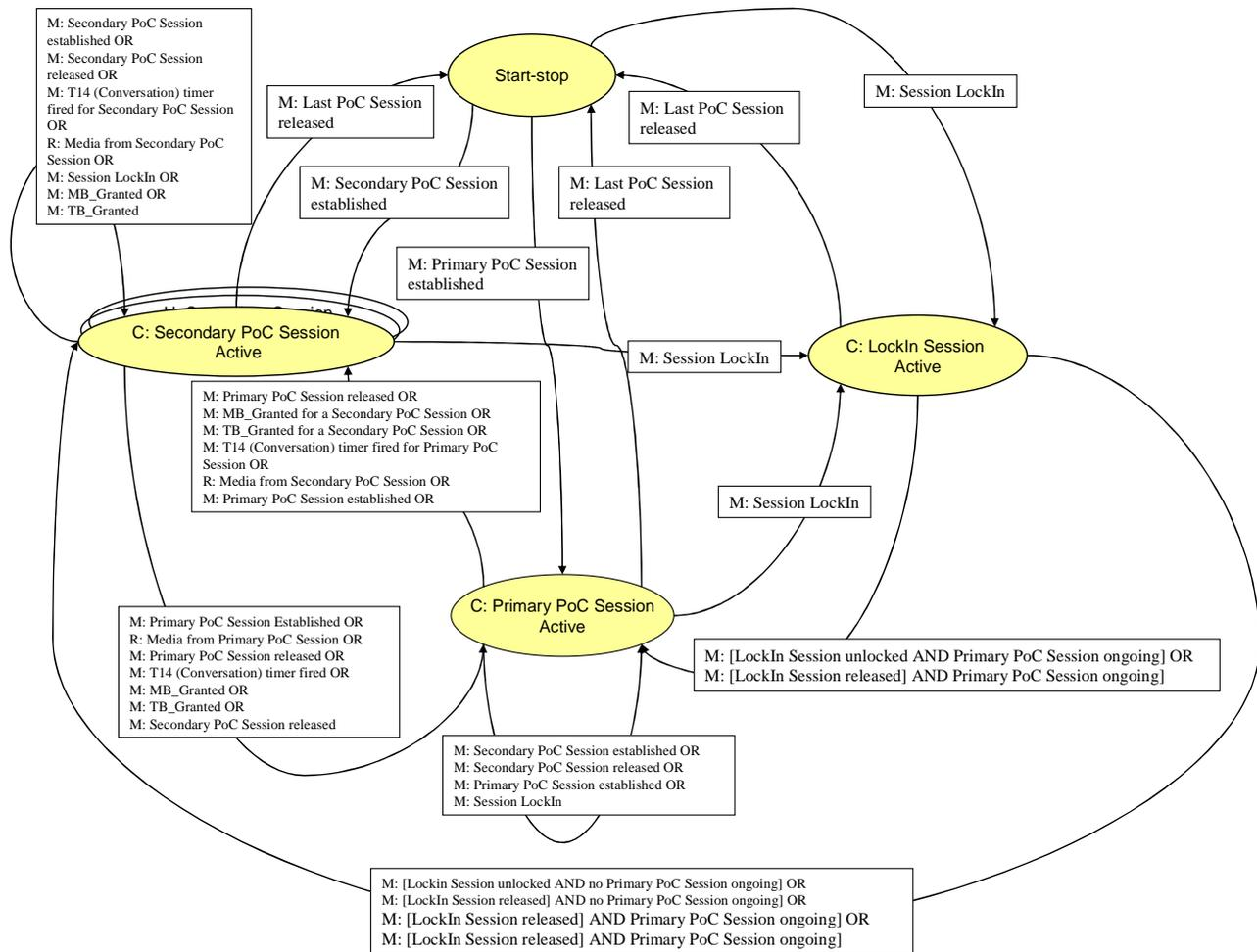

Figure 9: Simultaneous PoC Sessions state diagram - per PoC Client

State details are explained in the following subclauses.

If a TBCP message, MBCP message, SIP request or RTP Media packet arrives in any state and there is no procedure specified for it in the subclauses below the PoC Server SHALL discard the TBCP message, MBCP message, SIP request or RTP Media packet and SHALL remain in the current state.

NOTE 1: TBCP messages are defined in [OMA-PoC-1-UP].

NOTE 2: MSRP request and MSRP response relaying is not affected by the state machine.

6.3.7.1 State 'Start-stop'

The state 'Start-stop' is a stable state. In this state no PoC Session exists containing Continuous Media.

6.3.7.1.1 Monitor Primary PoC Session establishment (M: Primary PoC Session established)

When a Primary PoC Session including Continuous Media is established as specified in [OMA-PoC-CP] "PoC Session priority request" the PoC Server:

1. SHALL create an instance of the Simultaneous PoC Sessions state machine - per PoC Client; and,
2. SHALL enter the 'C: Primary PoC Session Active' state.

6.3.7.1.2 Monitor Secondary PoC Session establishment (M: Secondary PoC Session established)

When a Secondary PoC Session including Continuous Media is established as specified in the [OMA-PoC-CP] "*PoC Session priority request*" the PoC Server:

1. SHALL create an instance of the Simultaneous PoC Sessions state machine - per PoC Client; and,
2. SHALL enter the 'S: Secondary PoC Session Active' state.

6.3.7.1.3 Monitor SDP LockIn PoC Session establishment (M: Session LockIn)

When a PoC Session is established as specified in the [OMA-PoC-CP] "*PoC Session Locking request*" the PoC Server:

1. SHALL create an instance of the Simultaneous PoC Sessions state machine - per PoC Client; and,
2. SHALL enter the 'C: LockIn PoC Session Active' state.

6.3.7.2 State 'C: Primary PoC Session Active'

The "C: Primary PoC Session Active state" is a stable state. In this state a Primary PoC Session exists as an Active PoC Session. In the 'C: Primary PoC Session Active' state the PoC Server:

1. SHALL start the T14 (Conversation) timer upon receipt of the MBCP Media Burst Release message from the PoC Client or MBCP Media Bust Idle message from the PoC Server performing the Controlling PoC Function for this PoC Session;
2. SHALL start the T14 (Conversation) timer upon receipt of the TBCP Talk Burst Release message from the PoC Client or TBCP Talk Bust Idle message from the PoC Server performing the Controlling PoC Function for this PoC Session;
3. SHALL stop the T14 (Conversation) timer upon receipt of a Media Burst for this PoC Session;
4. SHALL relay RTP Media packets between the PoC Server performing the Controlling PoC Function and the PoC Client for this PoC Session; and,
5. SHALL NOT relay RTP Media packets between the PoC Server performing the Controlling PoC Function and the PoC Client for any other PoC Session(s).

6.3.7.2.1 Monitor Primary PoC Session release when no other PoC Sessions are established (M: Last PoC Session released)

When a Primary PoC Session is released or when all Continuous Media is disconnected from the PoC Session and no other PoC Sessions with Continuous Media for the same PoC Client are established as specified in [OMA-PoC-CP] the PoC Server:

1. SHALL enter the PoC Client state to 'Start-Stop' state.

6.3.7.2.2 Monitor SDP with PoC Session LockIn (M: Session LockIn)

When a Primary PoC Session is an Active PoC Session and the PoC Server receives the indication to lock this PoC Session with Continuous Media as specified in [OMA-PoC-CP] "*PoC Session locking request*" the PoC Server:

1. SHALL enter the 'C: LockIn PoC Session Active' state.

When the PoC Server receives SDP LockIn information for another PoC Session for this PoC Client as specified in [OMA-PoC-CP] "*PoC Session locking request*" the PoC Server either

1. SHALL enter the 'C: LockIn PoC Session Active' state if the PoC Client does not have the permission to send a Media Burst; for this Primary PoC Session;
- or,
2. SHALL
 - a. remain in the 'C: Primary PoC Session Active' state if the PoC Client has permission to send a Media Burst for this Primary PoC Session; and,
 - b. reject the LockIn request as specified in [OMA-PoC-CP] "*PoC Session locking request*".

NOTE: The LockIn request can be received when initializing a PoC Session or during the PoC Session.

6.3.7.2.3 Monitor Secondary PoC Session release (M: Secondary PoC Session released)

When a Secondary PoC Session is released as specified in [OMA-PoC-CP] the PoC Server:

1. SHALL remain in PoC Client state 'C: Primary PoC Session Active'.

6.3.7.2.4 Monitor Secondary PoC Session establishment (M: Secondary PoC Session established)

When a Secondary PoC Session is established as specified in [OMA-PoC-CP] "*PoC Client setting PoC Session priority*" the PoC Server:

1. SHALL remain in PoC Client state 'C: Primary PoC Session Active'.

6.3.7.2.5 Monitor Primary PoC Session release (M: Primary PoC Session released)

When a Primary PoC Session is released or when all Continuous Media for the Primary PoC Session is disconnected and other PoC Sessions with Continuous Media for the same PoC Client are ongoing the PoC Server:

1. SHALL enter to 'C: Secondary PoC Session Active' state.

6.3.7.2.6 Monitor Media Burst message (M: MB_Granted for a Secondary PoC Session)

When the PoC Server receives a MBCP Media Burst Granted message or a TBCP Talk Burst Granted message in response to a MBCP Media Burst Request message or a TBCP Media Burst Request message of the PoC Client for a Secondary PoC Session, the PoC Server:

1. SHALL enter the 'C: Secondary PoC Session active'.

6.3.7.2.7 T14 (Conversation) timer fired for Primary PoC Session

When T14 (Conversation) timer fires for the Primary PoC Session and at least one other Secondary PoC Session with Continuous Media for the same PoC Client is established as specified in the [OMA-PoC-CP] and fulfils conditions as defined in the subclause 7.5.2 "*Procedures at the PoC Server performing the Participating PoC Function*" to be activated, the PoC Server:

1. MAY either
 - a. send MBCP Media Burst Taken message to the PoC Client, if the Media Burst is on-going and if the PoC Session is established using procedures specified in this document;
 - or,
 - b. send TBCP Talk Burst Taken message to the PoC Client, if the Media Burst is on-going and if the PoC Session is established using procedures specified in [OMA-PoC-1-UP].

NOTE: The MBCP Media Burst Taken message and the TBCP Talk Burst Taken message is the same as the one received from the PoC Server performing the Controlling PoC Function in the beginning of the Media Burst.

2. SHALL enter the 'C: Secondary PoC Session active' state for the identified Secondary PoC Session.

6.3.7.2.8 Monitor Primary PoC Session establishment (M: Primary PoC Session established)

When a Primary PoC Session with Continuous Media is established or when a Secondary PoC Session becomes a Primary PoC Session as specified in [OMA-PoC-CP] "*PoC Session priority request*" the PoC Server:

1. SHALL remain in the state 'C: Primary PoC Session Active' state if the new PoC Session fulfils conditions as defined in the subclause 7.5.2 "*Procedures at the PoC Server performing the Participating PoC Function*" to be activated;

or,

2. SHALL enter the 'C: Secondary PoC Session active' state if the existing Primary PoC Session fulfils conditions as defined in the subclause 7.5.2 "*Procedures at the PoC Server performing the Participating PoC Function*" to be activated.

6.3.7.2.9 Monitor Talk Burst message (M: TB_Granted for a PoC Secondary PoC Session)

Perform the actions specified in subclause 6.3.7.2.6 "*Monitor Media Burst message (M: MB_Granted for a PoC Secondary PoC Session)*".

6.3.7.2.10 Monitor Secondary PoC Session receiving RTP Media packets (R: Media from Secondary PoC Session)

When receiving RTP Media packets in one of the Secondary PoC Sessions and that Secondary PoC Session fulfils conditions as defined in the subclause 7.5.2 "*Procedures at the PoC Server performing the participating PoC Function*" to be activated and the T14 (Conversation) timer has expired, the PoC Server:

1. MAY either
 - a. send MBCP Media Burst Taken message to the PoC Client, if the Media Burst is on-going and if the PoC Session is established using procedures specified in this document;

or,

 - b. send TBCP Talk Burst Taken message to the PoC Client, if the Media Burst is on-going and if the PoC Session is established using procedures specified in [OMA-PoC-1-UP].

NOTE: The MBCP Media Burst Taken message and the TBCP Taken message is the same as the one received from the PoC Server performing the Controlling PoC Function in the beginning of the Media Burst.

2. SHALL enter the 'C: Secondary PoC Session active' state for the identified Secondary PoC Session.

6.3.7.3 State: 'C: Secondary PoC Session Active'

The 'C: Secondary PoC Session active' state is a stable state. In this state a PoC Secondary PoC Session with Continuous Media exists as an Active PoC Session. In the 'C: Secondary PoC Session Active' state the PoC Server:

1. SHALL start the T14 (Conversation) timer upon receipt of the MBCP Media Burst Release message from the PoC Client or MBCP Media Bust Idle message from the PoC Server performing the Controlling PoC Function for this PoC Session;
2. SHALL start the T14 (Conversation) timer upon receipt of the TBCP Talk Burst Release message from the PoC Client or TBCP Talk Bust Idle message from the PoC Server performing the Controlling PoC Function for this PoC Session;

3. SHALL stop the T14 (Conversation) timer upon receipt of a Media Burst for this PoC Session;
4. SHALL relay RTP Media packets between the PoC Server performing the Controlling PoC Function and the PoC Client for this PoC Session; and,
5. SHALL NOT relay RTP Media packets between the PoC Server performing the Controlling PoC Function and the PoC Client for any other PoC Session(s).

6.3.7.3.1 Monitor Secondary PoC Session release when no other PoC Sessions are established (M: Last PoC Session released)

When the Secondary PoC Session is released or when all Continuous Media is disconnected from the Secondary PoC Session and no other PoC Sessions with Continuous Media for the same PoC Client are established as specified in [OMA-PoC-CP] "*PoC Session priority request*" the PoC Server:

1. SHALL enter the 'Start-stop' state.

6.3.7.3.2 Monitor SDP with PoC Session LockIn (M: Session LockIn)

When a Secondary PoC Session is an Active PoC Session and the Participating PoC Server receives the indication to lock the Active PoC Session with Continuous Media for this PoC Client as specified in [OMA-PoC-CP] "*PoC Session Locking request*" the PoC Server:

1. SHALL enter the 'C: LockIn PoC Session Active' state.

When the PoC Server receives SDP: LockIn information for another PoC Session for this PoC Client as specified in 7.5.2 "*PoC Session locking request*" the PoC Server either

1. SHALL enter the 'C: LockIn PoC Session Active' state if the PoC Client does not have the permission to send a Media Burst for this Secondary PoC Session;
- or,
2. SHALL perform the following actions:
 - a. remain in the 'C: Secondary PoC Session Active' state if the PoC Client has permission to send a Media Burst for this Secondary PoC Session; and,
 - b. reject the LockIn request as specified in [OMA-PoC-CP] "*PoC Session locking request*".

NOTE: The LockIn request can be received when initializing a PoC Session or during the PoC Session.

6.3.7.3.3 Monitor Primary PoC Session establishment (M: Primary PoC Session established)

When a Primary PoC Session with Continuous Media is established or when a Secondary PoC Session becomes a Primary PoC Session as specified in [OMA-PoC-CP] "*PoC Session priority request*" and that Primary PoC Session fulfils the criteria defined in the subclause 7.5.2 "*Procedures at the PoC Server performing the Participating PoC Function*" to be activated the PoC Server:

1. SHALL enter the state 'C: Primary PoC Session Active' if the changed PoC Session fulfils the conditions defined in the subclause 7.5.2 "*Procedures at the PoC Server performing the participating PoC Function*" to be activated;
- or,
2. SHALL remain in the 'C: Secondary PoC Session active' state if a Secondary PoC Session fulfils the conditions defined in the subclause 7.5.2 "*Procedures at the PoC Server performing the participating PoC Function*" to be activated.

6.3.7.3.4 Receive RTP Media packets (R: Media from Primary PoC Session)

Upon receiving RTP Media packets from a Primary PoC Session and that Primary PoC Session fulfills the criteria defined in the subclause 7.5.2 "Procedures at the PoC Server performing the Participating PoC Function" to be activated the PoC Server:

1. SHALL enter the 'C: Primary PoC Session Active' state.

NOTE: If the Primary PoC Session does not fulfill the criteria defined in the subclause 7.5.2 "Procedures at the PoC Server performing the Participating PoC Function" the PoC Server remains in the 'C: Secondary PoC Session Active' state.

6.3.7.3.5 Monitor Secondary PoC Session release (M: Secondary PoC Session released)

When the Secondary PoC Session is released or when all Continuous Media is disconnected from the Secondary PoC Session as specified in [OMA-PoC-CP] and at least one other PoC Session with Continuous Media for the same PoC Client is established and that other PoC Session fulfills the criteria defined in the subclause 7.5.2 "Procedures at the PoC Server performing the Participating PoC Function" the PoC Server to be activated the PoC Server:

1. SHALL remain in the state 'C: Secondary PoC Session Active' if the identified PoC Session is a Secondary PoC Session; or,
2. SHALL enter the 'C: Primary PoC Session Active' state if the identified PoC Session is a Primary PoC Session.

6.3.7.3.6 Monitor Secondary PoC Session establishment (M: Secondary PoC Session established)

When a Secondary PoC Session with Continuous Media is established as specified in the [OMA-PoC-CP] "PoC Session priority request", the PoC Server:

1. SHALL remain in the 'C: Secondary PoC Session Active'.

6.3.7.3.7 Monitor T14 (Conversation) timer fired for Secondary PoC Session (M: T14 (Conversation) timer fired)

When T14 (Conversation) timer fires for the Secondary PoC Session and at least one other PoC Session with Continuous Media for the same PoC Client is established as specified in the [OMA-PoC-CP] and fulfills conditions to be activated, the PoC Server:

1. MAY either
 - a. send a MBCP Media Burst Taken message to the PoC Client, if the Media Burst is on-going and if the PoC Session is a PoC Session established using procedures specified in this document;
 - or,
 - b. send a MBCP Media Burst Taken message to the PoC Client, if the Media Burst is on-going and if the PoC Session is a PoC Session established using procedures specified in [OMA-PoC-1-UP].
2. SHALL remain in the 'C: Secondary PoC Session active' state if the identified PoC Session is a Secondary PoC Session.

6.3.7.3.8 Receive RTP Media packets (R: Media from Secondary PoC Session)

Upon receiving RTP Media packets from a Secondary PoC Session different than the active PoC Session and that other PoC Session fulfills the criteria defined in the subclause 7.5.2 "Procedures at the PoC Server performing the participating PoC Function", the PoC Server:

1. SHALL remain in 'C: Secondary PoC Session Active' state for the Secondary PoC Session it received RTP Media packets from.

6.3.7.3.9 Monitor MBCP Media Burst Granted message (M: MB_Granted)

Upon receiving a MBCP Media Burst Granted message on another PoC Session the PoC Server:

1. SHALL enter the 'C: Primary PoC Session Active' state if that other PoC Session is a Primary PoC Session and fulfils the conditions defined in the subclause 7.5.2 "*Procedures at the PoC Server performing the participating PoC Function*" to be activated;

or,

2. SHALL remain in the 'C: Secondary PoC Session Active' state if that other PoC Session is a Secondary PoC Session and fulfils the conditions defined in the subclause 7.5.2 "*Procedures at the PoC Server performing the participating PoC Function*" to be activated.

6.3.7.3.10 Monitor TBCP Talk Burst Granted message (M: TB_Granted)

Upon receiving a Talk Burst Granted message on another PoC Session the PoC Server performs the actions specified in the 6.3.7.3.9 "*Receive MBCP Media Burst Granted message (R: MB_Granted primary)*".

6.3.7.4 State: 'C: LockIn PoC Session Active'

The 'U: LockIn PoC Session active' state is a stable state. In this state a LockIn PoC Session exists and is an Active PoC Session.

In the 'C: LockIn PoC Session Active' state the PoC Server:

1. SHALL relay RTP Media packets between the PoC Server performing the Controlling PoC Function and the PoC Client for this PoC Session; and,
2. SHALL NOT relay RTP Media packets between the PoC Server performing the Controlling PoC Function and the PoC Client for any other PoC Session(s).

6.3.7.4.1 Monitor LockIn PoC Session release and no other PoC Session ongoing (M: Last PoC Session released)

When a LockIn PoC Session is released and no other PoC Session with Continuous Media for the same PoC Client are ongoing the PoC Server:

1. SHALL enter the 'Start-stop' state.

6.3.7.4.2 Monitor LockIn PoC Session release and Primary PoC Session ongoing (M: [LockIn PoC Session released AND Primary PoC Session ongoing])

When a LockIn PoC Session is released or when all Continuous Media in the LockIn PoC Session is disconnected from the PoC Session and a Primary PoC Session with Continuous Media for the same PoC Client is ongoing and a PoC Session fulfils the criteria defined in the subclause 7.5.2 "*Procedures at the PoC Server performing the participating PoC Function*" as specified in [OMA-PoC-CP] "*PoC Session priority request*" the PoC Server:

1. SHALL enter the 'S: Primary PoC Session active' state if the identified PoC Session is a Primary PoC Session;

or,

2. SHALL enter the 'C: Secondary PoC Session Active' state if the identified PoC Session is a Secondary PoC Session.

6.3.7.4.3 Monitor LockIn PoC Session release and no Primary PoC Session ongoing (M: [LockIn PoC Session released AND no Primary PoC Session ongoing])

When a LockIn PoC Session is released and at least one Secondary PoC Session with Continuous Media for the same PoC Client is already established as specified in [OMA-PoC-CP] "*PoC Session priority request*" and fulfils criteria defined in subclause 7.5.2 "*Procedures at the PoC Server performing the Participating PoC Function*" to be activated the PoC Server:

1. SHALL enter the 'S: Secondary PoC Session active' state.

6.3.7.4.4 Monitor LockIn PoC Session is unlocked and Primary PoC Session ongoing (M: [LockIn PoC Session unlocked AND Primary PoC Session ongoing])

When a LockIn PoC Session is unlocked as specified in [OMA-PoC-CP] "*PoC Session Locking request*" and a Primary PoC Session with Continuous Media for the same PoC Client is already established and a PoC Session fulfills the criteria defined in the subclause 7.5.2 "*Procedures at the PoC Server performing the participating PoC Function*" as specified in the [OMA-PoC-CP] "*PoC Session priority request*" the PoC Server:

1. SHALL enter the 'C: Primary PoC Session active' state if the identified PoC Session is a Primary PoC Session;
or,
2. SHALL enter the 'C: Secondary PoC Session Active' state if the identified PoC Session is a Secondary PoC Session.

6.3.7.4.5 Monitor LockIn PoC Session is unlocked and no Primary PoC Session ongoing (M: [LockIn PoC Session unlocked AND no Primary PoC Session ongoing])

When a LockIn PoC Session is unlocked, as specified in [OMA-PoC-CP] "*PoC Session Locking request*" and no Primary PoC Session is ongoing and at least one Secondary PoC Session with Continuous Media for the same PoC Client is ongoing as specified in the [OMA-PoC-CP] and fulfils criteria defined in the subclause 7.5.2 "*Procedures at the PoC Server performing the Participating PoC Function*" to be activated, the PoC Server:

1. SHALL enter the 'C: Secondary PoC Session active'.

6.3.7.4.6 Monitor Media Burst Granted message (M: Granted Primary PoC Session)

Upon receiving the MBCP Media Burst Granted message or a TBCP Talk Burst Granted message on another Primary PoC Session the PoC Server:

1. SHALL enter the 'C: Primary PoC Session active' state if the other PoC Session is an Primary PoC Session; and,
2. SHALL unlock the LockIn PoC Session.

NOTE 1: The PoC Server unlocks the locked PoC Session without informing the PoC Client.

NOTE 2: If the MBCP Media Burst Granted message or the TBCP Talk Burst Granted message is received on the LockIn PoC Session no state change is needed.

6.3.7.4.7 Monitor Talk Burst Granted message (M: Granted Secondary PoC Session)

Upon receiving the MBCP Media Burst Granted message or a TBCP Talk Burst Granted message on another Secondary PoC Session the PoC Server:

1. SHALL enter the 'C: Secondary PoC Session active' state if the other PoC Session is an Secondary PoC Session;
and,
2. SHALL unlock the LockIn PoC Session.

NOTE 1: The PoC Server unlocks the locked PoC Session without informing the PoC Client.

NOTE 2: If the MBCP Media Burst Granted message or the TBCP Talk Burst Granted message is received on the LockIn PoC Session no state change is needed.

6.3.7.4.8 Monitor SDP with PoC Session LockIn (M: Session LockIn)

When the PoC Server receives SDP: LockIn information for another PoC Session for this PoC Client as specified in 7.5.2 "PoC Session locking request" the PoC Server either

1. SHALL remain in the 'C: LockIn PoC Session Active' state; and,
2. SHALL reject the LockIn request as specified in [OMA-PoC-CP] "PoC Session locking request" if the PoC Client have the permission to send Media for the already LockIn PoC Session.

6.3.8 Simultaneous PoC Sessions state diagram - per PoC Session

If the PoC Server supports Simultaneous PoC Sessions the PoC Server SHALL support the state diagram and the state transitions specified in this subclause for each PoC Session with Continuous Media.

A PoC Session established using the PoC 1 procedures SHALL use the procedures in [OMA-PoC-1-UP].

NOTE: There can be several 'Simultaneous PoC Sessions state diagram - per PoC Session' state machines running. The procedures to decide when a PoC Session is Active or Dormant are described in 6.3.7 "Simultaneous PoC Sessions state diagram - per PoC Client".

Figure 10 "Simultaneous PoC Sessions state diagram - per PoC Session" shows the state diagram for Simultaneous PoC Session per PoC Session.

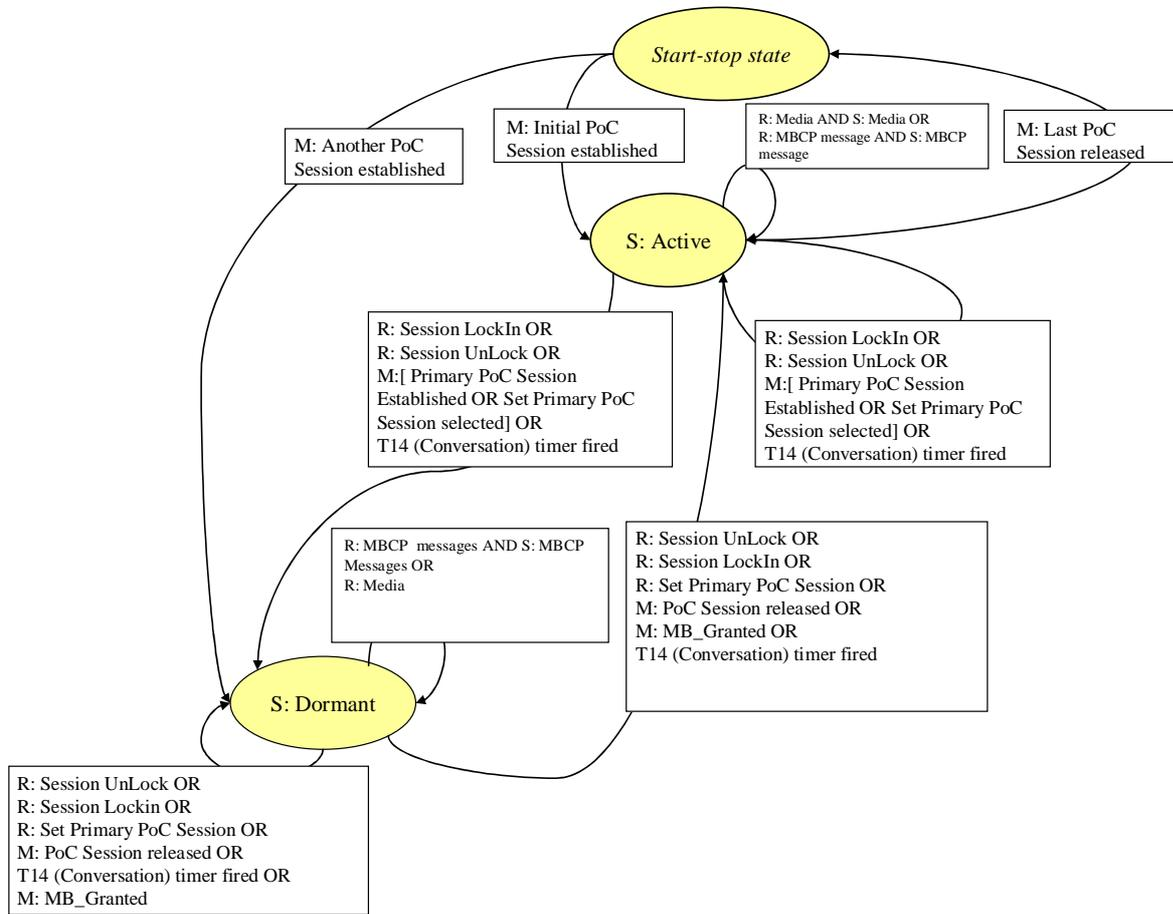

Figure 10: Simultaneous PoC Sessions state diagram - per PoC Session

The State Diagram in Figure 10 "Simultaneous *PoC Sessions state diagram - per PoC Session*" applies to one PoC Session out of multiple Simultaneous PoC Sessions supported the PoC Server for a PoC User.

The PoC Server SHALL create an instance of the state machine for each PoC Session.

State details are explained in the following subclauses.

If a MBCP message, SIP request or RTP Media packet arrives in any state and there is no procedure specified for it in the subclauses below the PoC Server SHALL discard the MBCP message, SIP request or RTP Media packet and SHALL remain in the current state.

NOTE: MSRP request and MSRP response relaying is not affected by the state machine.

6.3.8.1 State 'Start-Stop'

In this state no PoC Session state machine exists.

6.3.8.1.1 Initial PoC Session establishment (M: Initial PoC Session established)

When a PoC Session with Continuous Media is established as specified in [OMA-PoC-CP] "*PoC Session priority request*" and in case there is no active PoC Session for the same PoC User the PoC Server:

1. either
 - a. MAY create an instance of the Simultaneous PoC Sessions state machine per PoC Session; and,
 - b. SHALL enter the 'S: Active' state;
- or,
- c. SHALL remain in the 'Start-Stop' state.

6.3.8.1.2 Another PoC Session establishment (M: Another PoC Session established)

When a PoC Session with Continuous Media is established as specified in the [OMA-PoC-CP] "*PoC Session priority request*" the PoC Server:

1. SHALL create an instance of the Simultaneous PoC Sessions state machine per PoC Session; and,
2. SHALL enter the 'S: Dormant' state in case there is an Active PoC Session for the same PoC User.

6.3.8.2 State 'S: Active'

The 'S: Active' state of a PoC Session (one of the Simultaneous PoC Sessions) is a stable state.

In this state the PoC Server is receiving and sending RTP Media packets and MBCP messages of this PoC Session and monitoring MBCP messages and SIP requests with associated SDP information of other PoC Sessions and is reacting on PoC Session Events, as specified in the following subclauses.

6.3.8.2.1 Receive MBCP messages (R: MBCP Messages)

Upon receiving MBCP Messages from the PoC Client or Controlling PoC Function, the PoC Server:

1. SHALL relay the MBCP messages between the PoC Client or PoC Controlling PoC Function;
2. SHALL monitor MBCP and SIP messages for PoC Session; and,
3. SHALL remain in 'S: Active' state.

6.3.8.2.2 Receive RTP Media packets (R: Media)

Upon receiving RTP Media packets from the PoC Client or the PoC Server performing the Controlling PoC Function, the PoC Server:

1. SHALL relay the RTP Media packets between the PoC Client or PoC Server performing the Controlling PoC Function; and,
2. SHALL remain in 'S: Active' state.

6.3.8.2.3 Monitor PoC Session release when no other PoC Sessions are ongoing (M: Last PoC Session released)

When the PoC Session is released or all Continuous Media is disconnected from the PoC Session and no other PoC Sessions with Continuous Media for the same PoC Client are ongoing as specified in [OMA-PoC-CP] "*PoC Session priority request*" the PoC Server:

1. SHALL return to the 'Start-stop state'.

6.3.8.2.4 Receive SDP with Session LockIn (R: Session LockIn)

Upon receiving an indication from the PoC Client that a PoC Session is to be locked the PoC Server:

1. SHALL proceed with message handling as specified in [OMA-PoC-CP] "*PoC Session locking request*"; and,

2. if the locked indication is for the active PoC Session, the PoC Server:
 - a. SHALL remain in 'S: Active' state.
3. Otherwise the PoC Server:
 - a. SHALL enter the 'S: Dormant' state.

6.3.8.2.5 Monitor SDP with Session UnLock (M: Session UnLock)

Upon receiving an indication from the PoC Client that this PoC Session is to be unlocked, the PoC Server:

1. SHALL proceed with message handling as specified in [OMA-PoC-CP] "*PoC Session locking request*"; and,
2. if criteria defined in the subclause 7.5.2 "*Procedures at the PoC Server performing the Participating PoC Function*" for switching to another PoC Session are fulfilled the PoC Server:
 - a. SHALL enter the 'S: Dormant' state.
3. Otherwise the PoC Server:
 - a. SHALL remain in the 'S: Active' state.

6.3.8.2.6 T14 (Conversation) timer fired

On expiry of the T14 (Conversation) timer for the PoC Session and,

1. if criteria specified in the subclause 7.5.2 "*Procedures at the PoC Server performing the Participating PoC Function*" for switching to another PoC Session are fulfilled the PoC Server:
 - a. SHALL enter the 'S: Dormant' state.
2. Otherwise the PoC Server:
 - a. SHALL remain in the 'S: Active' state.

6.3.8.2.7 Monitor SDP with Primary PoC Session established or selected (M: [Primary PoC Session established OR Primary PoC Session selected])

Upon receiving an indication from the PoC Client that a Primary PoC Session with Continuous Media has been established or should become the Active PoC Session, based on new priority settings and,

1. if criteria defined in the subclause 7.5.2 "*Procedures at the PoC Server performing the Participating PoC Function*" for switching to another PoC Session are fulfilled the PoC Server:
 - a. SHALL enter the 'S: Dormant' state.
2. Otherwise the PoC Server:
 - a. SHALL remain in the 'S: Active' state.

6.3.8.3 State: 'S: Dormant'

The 'S: Dormant' state of a PoC Session (out of Simultaneous PoC Sessions) is a stable state.

In this state the PoC Participating Function is monitoring MBCP and SIP messages pertaining to this PoC Session and to all other PoC Sessions of the same PoC User and is reacting on PoC Session Activation events as specified in the following subclauses.

6.3.8.3.1 Receive MBCP message (R: MBCP messages)

Upon receiving MBCP Messages from the PoC Client or PoC Controlling Function, the PoC Server:

1. MAY relay the MBCP messages between the PoC Client and Controlling PoC Function according to rules as specified in subclause 5.4 "RTCP";
2. SHALL continue to monitor MBCP and SIP messages; and,
3. SHALL remain in 'S: Dormant' state.

6.3.8.3.2 Receive RTP Media packets (R: Media)

Upon receiving RTP Media packets from the PoC Controlling PoC Function, the PoC Server:

1. SHALL discard the RTP Media packet; and,
2. SHALL remain in 'S: Dormant' state.

6.3.8.3.3 Receive SDP with SIP Session LockIn (R: Session LockIn)

Upon receiving an indication from the PoC Client that the PoC Session is to be locked, the PoC Server:

1. SHALL proceed with message handling as specified in [OMA-PoC-CP] "*PoC Session locking request*"; and,
2. if the locked indication is for another PoC Session, the PoC Server:
 - a. SHALL remain in 'S: Dormant' state.
3. Otherwise the PoC Server:
 - a. SHALL enter the 'S: Active' state.

6.3.8.3.4 Receive SDP with Primary PoC Session selected (R: Set Primary PoC Session)

Upon receiving an indication from the PoC Client that the PoC Session is to be selected as the Primary PoC Session and,

1. if the Primary PoC Session setting is for this PoC Session and if criteria defined in the 7.5.2 "*Procedures at the PoC Server performing the Participating PoC Function*" for switching to another PoC Session are fulfilled the PoC Server:
 - a. SHALL enter the 'S: Active' state if no other PoC Sessions is in the state "LockIn".
2. Otherwise the PoC Server:
 - a. SHALL enter the 'S: Dormant' state if any other PoC Session is in the state "LockIn".

6.3.8.3.5 Receive SDP with SIP Session UnLock (R: Session UnLock)

Upon receiving an indication from the PoC Client that this PoC Session is to be unlocked the PoC Server:

1. SHALL proceed with message handling as specified in [OMA-PoC-CP] "*PoC Session locking request*", and,
2. if criteria defined in the subclause 7.5.2 "*Procedures at the PoC Server performing the Participating PoC Function*" for switching to another PoC Session are fulfilled the PoC Server:
 - a. SHALL enter the 'S: Active' state, and;
 - b. MAY send the latest MBCP Media Burst Taken message for the activated PoC Session to the PoC Client.
3. Otherwise the PoC Server:
 - a. SHALL remain in the 'S: Dormant' state.

6.3.8.3.6 Monitor PoC Session release (M: PoC Session released)

Upon receiving an indication from the PoC Client or the PoC Server performing the Controlling PoC Function that another PoC Session has been released or all Continuous Media in that other PoC Session is disconnected and,

1. if criteria defined in the subclause 7.5.2 "*Procedures at the PoC Server performing the Participating PoC Function*" for switching to another PoC Session are fulfilled the PoC Server:
 - a. SHALL enter the 'S: Active' state; and,
 - b. MAY send the latest MBCP Media Burst Taken message for the activated PoC Session to the PoC Client.
2. Otherwise the PoC Server:
 - a. SHALL remain in the 'S: Dormant' state.

6.3.8.3.7 Monitor Media Burst Granted message (M: MB_Granted)

Upon receiving a MBCP Media Burst Granted message as the response to a MBCP Media Burst Request message from the PoC Client and,

1. if criteria defined in the subclause 7.5.2 "*Procedures at the PoC Server performing the Participating PoC Function*" for switching to this PoC Session are fulfilled the PoC Server:
 - a. SHALL enter the 'S: Active' state.
2. Otherwise the PoC Server:
 - a. SHALL remain in the 'S: Dormant' state.

6.3.8.3.8 T14 (Conversation) timer fired

On expiry of the T14 (Conversation) timer for another PoC Session, and,

1. if criteria defined in the subclause 7.5.2 "*Procedures at the PoC Server performing the Participating PoC Function*" for switching to this PoC Session are fulfilled the PoC Server:
 - a. SHALL enter the 'S: Active' state; and,
 - b. MAY send the latest MBCP Media Burst Taken message for the activated PoC Session to the PoC Client.
2. Otherwise the PoC Server:
 - a. SHALL remain in the 'S: Dormant' state.

6.4 Procedures at the PoC Server performing the Controlling PoC Function

6.4.1 General

The PoC Server SHALL support the procedures specified in subclause 6.4.4 "*PoC Server state transition diagram for general Media Burst operation*".

The PoC Server SHALL support the procedures specified in subclause 6.4.5 "*PoC Server state transition diagram for basic Media Burst operation to the PoC Client*".

The PoC Server MAY support the procedures specified in subclause 6.4.6 "*State transition diagram for general MSRP request distribution*".

6.4.2 Controlling PoC Function procedures at PoC Session initialization

When a PoC Session is established a new instance of the PoC Server state machine for 'general Media Burst operation' is created for each agreed Media-floor Control Entity.

As each Participant and each agreed Media-floor Control Entity, is added to the PoC Session, new instances of the PoC Server state machine for 'basic Media Burst operation' to the PoC Client is created for each PoC Client and used Media-floor Control Entity.

The original initial SIP INVITE / SIP REFER request to establish a 1-1 PoC Session, an Ad-hoc PoC Group Session or a Pre-arranged PoC Group Session (regardless if the PoC Session is ongoing or not) is treated as an implicit Media Burst request for the Media-floor Control Entity, to which only PoC Speech is bound, and the PoC Server state machine for basic Media Burst operation to the PoC Client for that PoC Client behaves as if a MBCP Media Burst Request message has been received.

If the optional "queuing" feature is supported and has been negotiated for the Media-floor Control Entity, the PoC Server could queue the implicit Media Burst request for the Media-floor Control Entity.

The original initial SIP INVITE / REFER request to establish a Chat PoC Group Session or to rejoin an ongoing PoC Session (regardless of type of PoC Session) is not handled as an implicit Media Burst request message by the PoC Server.

The permission to send a Media Burst to the Inviting PoC Client due to implicit Media Burst request is applicable to both Confirmed Indication and Unconfirmed Indication for all kinds of Media Type. The implicit Media Burst request is applicable by default whenever PoC Speech is bound. The implicit Media Burst request for other Media Types can only be negotiated on the PoC Session set-up.

If `tb_granted` value set to 1 is included in the SIP 200 "OK" response as specified in [OMA-PoC-CP] "*Media Burst Control Protocol MIME registration*" and if the PoC Server performing the Participating PoC Function does not stay on the Media path, the PoC Server does not send MBCP Media Burst Granted message corresponding to the implicit Media Burst request.

If the PoC Client has indicated support for Media buffering and the PoC Server has indicated to the PoC Client to buffer Media the PoC Server optionally can delay granting the permission to send a Media Burst up until a Confirmed Indication is received from the Participating PoC Function.

When the first Unconfirmed Indication is received from the Participating PoC Function the PoC Server optionally can give an early indication to send RTP Media packets for each used Media-floor Control Entity, to which PoC Speech is bound, to the Inviting PoC Client, see [OMA-PoC-CP] "*Controlling PoC Function procedures*". If an early indication to send RTP Media packets is given to the Inviting PoC Client, the PoC Client is granted the permission to send a Media Burst for each used Media-floor Control Entity, to which PoC Speech is bound and the PoC Server buffers RTP Media packets received from the PoC Client at least until the first Invited PoC User accepts the invitation or until the RTP Media packet buffer exceeds its maximum limit to store RTP Media packets. If Limited Segment Media Buffer Preload is used a two phase process is initiated; the first phase, called the preload phase, takes place before the Inviting PoC Client receives a MBCP Media Burst Grant message (which would typically be sent by the Controlling PoC Function when at least one Confirmed Indication has been received from a Participating PoC Function). During the preload phase the PoC Client sends an amount of RTP Media packets limited by the value of the SDP parameter `tb_seg_preload`, see [OMA-PoC-CP] "*Controlling PoC Function procedures*" and once the PoC Client has sent this limited amount of RTP Media packets, the PoC Client stops sending further RTP Media packets and instead buffers Media until the preload phase finishes. After the preload phase finishes the PoC Client will resume sending RTP Media packets.

NOTE 1: The amount of RTP Media packets the PoC Server buffers is an implementation option.

If the PoC Server does not support or does not allow PoC Client Media buffering then when an early indication to send RTP Media packets is not given to the Inviting PoC Client the PoC Client is granted the permission to send a Media Burst for each used Media-floor Control Entity when the first Invited PoC Client accepts the Media.

Before the PoC Server sends the first Media Burst Control Protocol message in the PoC Session, the PoC Server has to assign itself a SSRC identifier to be included in the Media Burst Control Protocol messages and quality feedback messages if the PoC Server is supporting that option. A suitable algorithm to generate the SSRC identifier is described in [RFC3550].

The PoC Client and the PoC Server can negotiate the maximum priority level that the PoC Client is permitted to request in "tb_priority" as specified in [OMA-PoC-CP] "*Media Burst Control Protocol MIME registration*". The PoC Server queues the Media Burst Request and can pre-empt the current sender based on the negotiated maximum priority level that the PoC Client is permitted to request and the priority level included in the MBCP Media Burst Request.

NOTE 2: The PoC Server policy determining the highest priority level, which can be offered and answered to a PoC User, is out of scope for this specification.

Based on negotiation during a PoC Session establishment or during the PoC Session as specified in [OMA-PoC-CP] "*Media Burst Control Protocol MIME registration*" the Local Granted Mode can be used by the PoC Client for the Media-floor Control Entity to which PoC Speech is bound.

6.4.3 Controlling PoC Function procedures at PoC Session release

When a PoC Client leaves a PoC Session, but the PoC Session remains ongoing with the other PoC Clients, the PoC Server follows a two-stage procedure.

1. In the first stage, the PoC Server stops sending MSRP messages, MBCP messages and RTP Media packets to the PoC Client leaving the PoC Session and the PoC Server discards MSRP messages, MBCP messages and RTP Media packets received from the PoC Client leaving the PoC Session.
2. In the second stage, when the Control Plane has determined that the PoC Session with this PoC Client has been released, the corresponding instance of the PoC Server state machine for 'basic Media Burst operation' to the PoC Client is released.

There are no cases where the PoC Server state machine for basic Media Burst operation to the PoC Client will cause the PoC Client to be dropped from a PoC Session.

When a PoC Session is released, the PoC Server follows a two-stage procedure.

1. In the first stage, the PoC Server stops sending MSRP messages, MBCP messages and RTP Media packets to all PoC Clients in the PoC Session.
2. In the second stage, when the Control Plane has determined that the PoC Session has been released, the corresponding instance of the PoC Server state machine for 'general Media Burst operation' or 'general MSRP request distribution' or both are also terminated, along with any PoC Server state machines for basic Media Burst operation to the PoC Clients in the PoC Session.

The PoC Server state machine for general Media Burst operation initiates the PoC Session release depending on the release policy specified in [OMA-PoC-CP] "*PoC Session release policy*".

The state machines describing the procedures on the PoC Session release are described in subclauses 6.4.4 "*PoC Server state transition diagram for general Media Burst operation*", 6.4.5 "*PoC Server state transition diagram for basic Media Burst operation to the PoC Client*", 6.4.6 "*State transition diagram for general MSRP request distribution*" and 6.4.7 "*Discrete Media procedures – basic*".

6.4.3A PoC Server procedures at PoC Session modification

6.4.3A.1 Controlling PoC Function procedures when adding a Media Type to a PoC Session

When a new Media-floor Control Entity, which has not been used by any PoC Client yet, is agreed for a PoC Client,

1. a new instance of the PoC Server state machine for 'general Media Burst operation' for the PoC Session is created by PoC Server,
2. a new instance of the PoC Server state machine for basic Media Burst operation to the PoC Client for the PoC Client and the Media-floor Control Entity is created by PoC Server.

When a new Media-floor Control Entity, which is already used by other PoC Clients, is offered and accepted by a PoC Client, the PoC Server:

1. creates a new instance of the PoC Server state machine for 'basic Media Burst operation to the PoC Client' for the PoC Client and the Media-floor Control Entity.

If a new Media Type is agreed, the PoC Server starts handling the Media Type.

6.4.3A.2 Controlling PoC Function procedures when disconnecting from a Media Type

If disconnecting from a Media Type is initiated by the PoC Server towards a PoC Client the PoC Server SHALL stop sending the Media Type towards the PoC Client.

If disconnecting from an existing Media Type is agreed for a PoC Client, the PoC Server releases the resources used by that Media Type towards the PoC Client.

When removing of the binding to a Media-floor Control Entity by a PoC Client is agreed, the PoC Server SHALL terminate the 'basic Media Burst operation to the PoC Clients' as specified in 6.4.5 "*PoC Server state transition diagram for basic Media Burst operation to the PoC Client*".

NOTE 1: The removal of a binding to a Media-floor Control Entity is always initiated by the PoC Client and the procedure can be done in one step.

When the removal of an existing Media-floor Control Entity from the PoC Session is initiated by the PoC Server, the PoC Server:

NOTE 2: The removal of a Media-floor Control Entity from the PoC Session is always initiated by one of the Participants in the PoC Session and results in that the PoC Server initiates the modification of the PoC Session as specified in [OMA-PoC-CP] "*Request initiated by the Controlling PoC Function*" towards the other Participants in the PoC Server.

1. SHALL stop distributing Media on that Media-floor Control Entity; and,
2. SHALL stop sending Media Burst Control messages associated with the Media-floor Control Entity.

When removing an existing Media-floor Control Entity from the PoC Session is agreed for a PoC Client, the PoC Server:

1. SHALL terminate the PoC Server state machines for 'basic Media Burst operation to the PoC Clients' as specified in 6.4.5 "*PoC Server state transition diagram for basic Media Burst operation to the PoC Client*"; and,
2. SHALL terminate the PoC Server state machine for 'general Media Burst operation'.

6.4.3A.3 Controlling PoC Function procedures when connecting to a Media Type

If the Media-floor Control Entity was not previously used by the PoC Client, a new instance of the PoC Server state machine for basic Media Burst operation for the PoC Client and the Media-floor Control Entity is created by PoC Server.

If connecting to an existing Media Type is agreed for a PoC Client, the PoC Server can send and receive this Media Type to and from the PoC Client.

6.4.4 PoC Server state transition diagram for general Media Burst operation

The PoC Server SHALL support the state diagram and the state transitions specified in this subclause when Continuous Media or Discrete Media or both are bound to a Media-floor Control Entity.

NOTE 1: The sending or receiving of reports related to Discrete Media are described in subclauses 7.12 "*Discrete Media Transfer Final Report*" and 7.13 "*Discrete Media Transfer Progress Report*".

NOTE 2: The optional MBCP features "queuing" and "tb_priority" are specified in [OMA-PoC-CP] "Media Burst Control Protocol MIME registration".

Figure 11 "PoC Server state transition diagram for general Media Burst operation" shows the general Media Burst operation states (G states) and the state transition diagram.

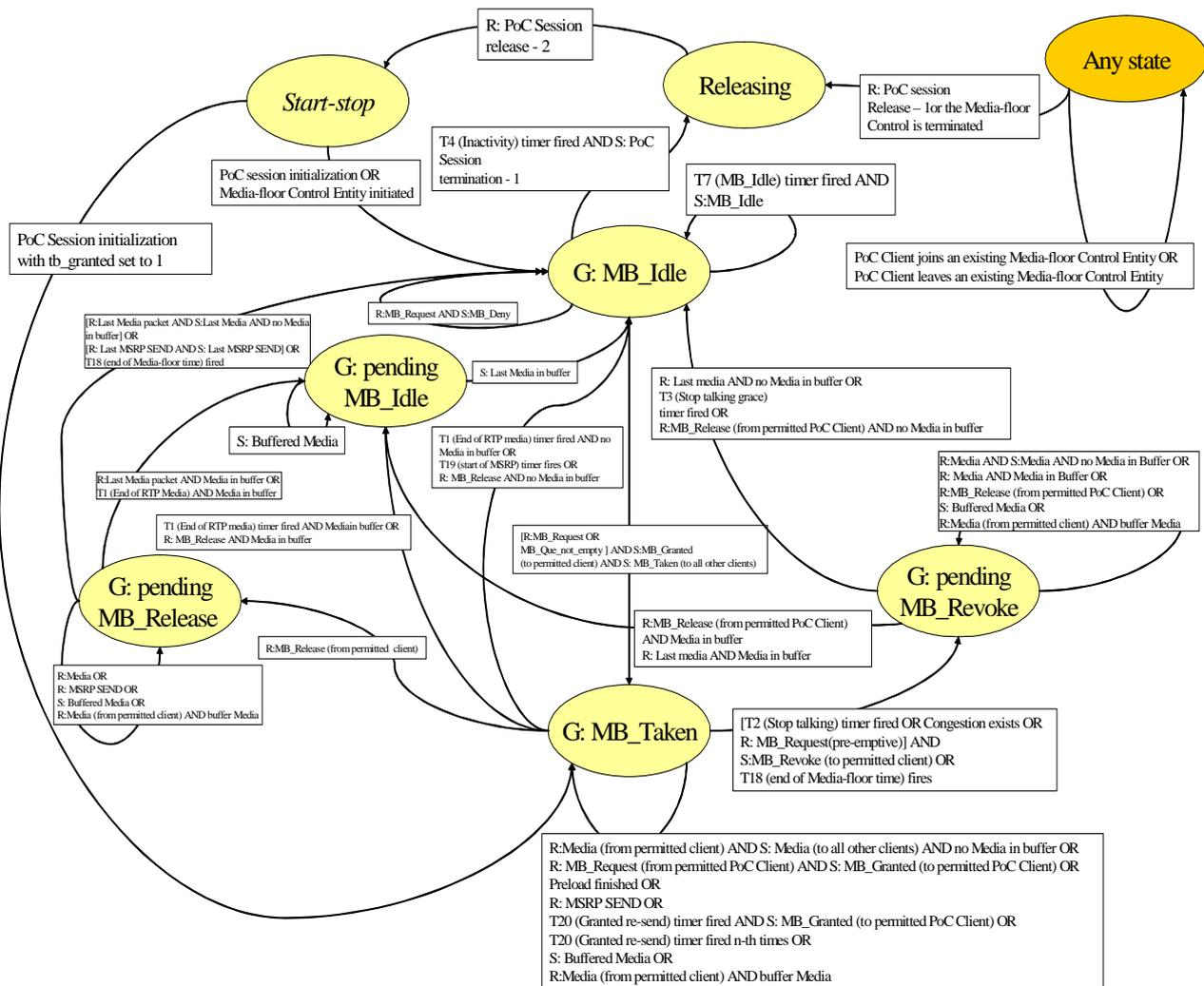

Figure 11: PoC Server state transition diagram for general Media Burst operation

The PoC Server SHALL keep one instance of the general Media Burst operation state machine per PoC Session.

State details are explained in the following subclauses.

If a MBCP message, a MSRP message or a RTP Media packet arrives in any state and there is no procedure specified for it in the subclauses below the PoC Server SHALL discard the MBCP message, the MSRP message or the RTP Media packet and SHALL remain in the current state.

When the PoC Server negotiates with the PoC Client the Talk Burst Control Protocol as specified in [OMA-PoC-1-UP] instead of the Media Burst Control Protocol, the PoC Server:

1. SHALL handle the TBCP message received from the PoC Client as the MBCP message of the same subtype; and,
2. SHALL generate and send towards the PoC Client in the subclauses below the TBCP message instead of the MBCP message as follows:
 - a. the TBCP message of the same subtype is generated; and,
 - b. the TBCP message fields with the same content are included into the TBCP message.

6.4.4.1 State 'Start-stop

In this state, the Media-floor Control Entity does not exist.

6.4.4.1.1 PoC Session initialization

When a PoC Session is initiated as specified in [OMA-PoC-CP] and in case of Confirmed Indication and at least one Invited PoC Client has accepted the invitation, the PoC Server:

NOTE: In case of Unconfirmed Indication the PoC Server does not wait for an acceptance from an Invited PoC Client.

1. SHALL create an instance of the general Media Burst operation state machine;
2. SHALL wait for the PoC Server state machine transition diagram for normal Media Burst operation to the PoC Client to be initialized before continuing the following steps.
3. SHALL when the PoC Server state machine transition diagram for normal Media Burst operation to the PoC Client is initialized:
 - a. perform the actions specified in subclause 6.4.4.2.2 "*Receive MBCP Media Burst Request message (R: MB_Request)*" if SDP parameter *tb_granted* set to 0 as specified in [OMA-PoC-CP] "*Media Burst Control Protocol MIME registration*" or is not included and if the PoC Server is granting an Implicit Media Burst Request at PoC Session establishment;
 - or,
 - b. perform the actions specified in the subclause 6.4.4.3.1 "*Enter the state 'G: MB_Taken'*", if SDP parameter *tb_granted* set to 1 is negotiated as specified in [OMA-PoC-CP] "*Media Burst Control Protocol MIME registration*";
 - or otherwise,
 - c. perform the actions specified in the subclause 6.4.4.2.1 "*Enter state 'G: MB_Idle'*".

6.4.4.1.2 Media-floor Control Entity initiated

When the Control Plane [OMA-PoC-CP] has negotiated a Media-floor Control Entity during an on-going PoC Session the PoC Server:

1. SHALL create one instance of the 'PoC Server state transition diagram for general Media Burst operation 'state machine; and,
2. SHALL wait for the PoC Server state machine transition diagram for normal Media Burst operation to the PoC Client to be initialized before continuing the following steps.

When the PoC Server state machine transition diagram for normal Media Burst operation to the PoC Client is initiated the PoC Server:

1. SHALL perform the actions in subclause 6.4.4.2.1 "*Enter state 'G: MB_Idle'*".

6.4.4.2 State 'G: MB_Idle'

The 'G: MB_Idle' state is a stable state. The PoC Server is in this state when no PoC User currently has permission to send a Media.

The timer T4 (Inactivity) and the timer T7 (MB_Idle) can be running when the PoC Server is in this state.

NOTE: During the initialization of the PoC Session Control Plane timers supervise the general state machine.

6.4.4.2.1 Enter state 'G: MB_Idle'

When entering this state from any state except the 'Null state' and if no Participant negotiated "queuing" or "tb_priority", the PoC Server:

1. SHALL send the MBCP Media Burst Idle message to all PoC Clients unless otherwise specified in the User specific state machine 6.4.5 '*PoC Server state transition diagram for basic Media Burst operation to the PoC Client*';
2. SHALL start T7 (MB_Idle) timer;
3. SHALL start the T4 (Inactivity timer); and,
4. SHALL set the general state to 'G: MB_Idle' state.

When entering this state from any state except the 'Null state' and if a Participant negotiated "queuing" or "tb_priority" the PoC Server checks the Media Burst request queue.

1. If the Media Burst request queue is empty the PoC Server
 - a. SHALL send the MBCP Media Burst Idle message to all PoC Clients unless otherwise specified in the User specific state machine 6.4.5 '*PoC Server state transition diagram for basic Media Burst operation to the PoC Client*';
 - b. SHALL start T7 (MB_Idle) timer;
 - c. SHALL start the T4 (Inactivity timer); and,
 - d. SHALL set the general state to 'G: MB_Idle' state.
2. If the Media Burst request queue is not empty the PoC Server
 - a. SHALL perform actions in subclause 6.4.4.2.5 "*Media Burst request queue not empty*".

6.4.4.2.2 Receive MBCP Media Burst Request message (R: MB_Request)

Upon receiving a MBCP Media Burst Request message (from a PoC Client that is permitted to make a request) and

1. if there is only one Participant in the PoC Session or if the negotiated maximum priority level that the PoC Client is permitted to request is receive only or if only one Participant is connected to this Media-floor Control Entity and the PoC Server chooses to send a MBCP Media Burst Deny message the PoC Server:
 - a. SHALL reject the request.
2. if there is only one Participant in the PoC Session or if only one Participant is connected to this Media-floor Control Entity and the PoC Server did not choose to send a MBCP Media Burst Deny message to the PoC Client or there is more than one Participant in the PoC Session, the PoC Server:
 - a. SHALL grant the request.
3. if the Media Burst is rejected the PoC Server:
 - a. SHALL send MBCP Media Burst Deny message.

The MBCP Media Burst Deny message

- i. SHALL include in the reason code field:
 1. 2, if PoC Server is not able to grant the Media Burst due to an internal error;
 2. 3, if the requesting PoC User is the only Participant in the PoC Session or the only one connected to this Media-floor Control Entity;
 3. 4, if the retry-after timer is still running; or,
 4. 5, if the requesting PoC User has only receive only privilege; or
 5. 6, if the PoC Server is denying the Media Burst due to congestion, as defined in subclause 7.7 "Media Transfer"; or
 6. 255, if another reason.
 - ii. MAY include in the Reason phrase field:
 1. "Internal PoC Server error", if PoC Server is not able to grant the Media Burst due to an internal error; or,
 2. "Only one Participant", if the requesting PoC User is the only Participant in the PoC Session or the only one connected to this Media-floor Control Entity; or,
 3. "Retry-after timer has not expired", if the retry-after timer is still running; or,
 4. "Listen only", if the requesting PoC User has only listen only privilege and only PoC Speech is bound to Media-floor Control Entity or "Receive only", if the requesting PoC User has only receive only privilege and other Media Types than PoC Speech is bound to Media-floor Control Entity; or,
 5. "No resources available", if PoC Server is denying the Media Burst due to congestion, as defined in subclause 7.7 "Media Transfer"; or,
 6. "Other reason" ", if the PoC Server denies the request for another reason.
 - b. SHALL remain in the 'G: MB_Idle' state.
4. if the Media Burst is granted the PoC Server:
- a. SHALL stop the T4 (Inactivity) timer;
 - b. SHALL stop the T7 (MB_Idle) timer;
 - c. SHALL store the SSRC of PoC Client requesting a permission to send a Media Burst until the end of the Media Burst associated to that Media Burst Request; and,
 - d. SHALL perform the actions specified in the subclause 6.4.4.3.1 "Enter the state 'G: MB_Taken'".

NOTE: An initial SIP INVITE request in an On-demand Session or a SIP REFER request in a Pre-established Session is interpreted as a Media Burst request.

6.4.4.2.3 T7 (MB_Idle) timer fired

On expiry of the T7 (Media Burst Idle) timer the PoC Server:

1. SHALL restart the T7 (Media Burst Idle) timer. The MBCP Media Burst Idle message SHALL be sent only n times (not forever), so the timer SHALL only be restarted, if not yet restarted n times;

2. SHALL send a MBCP Media Burst Idle message to all PoC Clients in the PoC Session; and,
3. SHALL remain in the 'G: MB_Idle' state.

6.4.4.2.4 T4 (Inactivity) timer fired

On expiry of T4 (Inactivity) timer and

1. if the criteria for releasing the PoC Session as specified in [OMA-PoC-CP] "*PoC Session release policy*" is fulfilled the PoC Server
 - a. SHALL release the PoC Session as specified in [OMA-PoC-CP] "*Removal of Participants from a PoC Session*"; and,
 - b. SHALL enter the 'Releasing' state.
2. Otherwise the PoC Server based on a configurable Service Provider Policy either
 - a. SHALL
 - i. disconnect all PoC Clients from this Media-floor Control Entity as specified in [OMA-PoC-CP] "*PoC Session Modification*"; and,
 - ii. enter the 'Releasing' state.
 - or,
 - b. SHALL remain in the 'G: MB_Idle' state.

NOTE: The disconnection of the Participants from this Media-floor Control Entity, MSRP session release and PoC Session release is specified in subclause 6.4.4.6 "*Any state*".

6.4.4.2.5 Media Burst request queue not empty

If a Participant negotiated "queuing" or "tb_priority" and if the Media Burst request queue is not empty, the PoC Server:

1. SHALL select the queued PoC Client from the head of the Media Burst request queue;
2. SHALL remove that PoC Client from the Media Burst request queue;
3. SHALL perform the actions described in the subclause 6.4.4.3.1 "*Enter the state 'G: MB_Taken'*" with respect to that PoC Client; and,
4. SHOULD send a MBCP Media Burst Request Queue Status message with the updated status to the PoC Clients in the Media Burst request queue which negotiated "queuing", which have requested the queue status and whose queue position has been changed since the previous MBCP Media Burst Request Queue Status message.

The MBCP Media Burst Request Queue Status message:

- a. SHOULD indicate the position of the PoC Client in the Media Burst request queue; and,
- b. MAY indicate the priority level of the PoC Client in the Media Burst request queue

NOTE: In congested situation the PoC Server can determine to not send the MBCP Media Burst Request Queue Status message based on local policy.

6.4.4.3 State 'G: MB_Taken'

The 'G: MB_Taken' state is a stable state and the PoC Server uses this state when it has permitted one of the PoC Clients in the PoC Session to send a Media Burst.

In this state the PoC Client can send one or more MSRP SEND requests.

The timer T1 (End of RTP) can be running when the PoC Server is in this state and when Continuous Media is bound to the Media-floor Control Entity.

The timer T2 (Stop talking) can be running when the PoC Server is in this state and when only Continuous Media is bound to the Media-floor Control Entity.

The T18 (end of Media-floor time) timer is running to supervise the total time the PoC Client can occupy the Media-floor when Discrete Media is bound to the Media-floor Control Entity.

The T19 (start of MSRP) timer is running to supervise the reception of the first MSRP SEND request after the MBCP Media Burst Granted message has been sent to the PoC Client when only Discrete Media is bound to the Media-floor Control Entity.

The T20 (Granted re-send) timer is running to guarantee reliable delivery of the MBCP Media Burst Granted message, if the granted PoC Client was queued and if the PoC Client supports "queuing".

During this state PoC Server can buffer RTP Media packets towards PoC Clients, e.g. when

- an Early indication to send RTP Media packets is used and the Media path has not yet been established towards a Invited PoC Client; and,
- if Limited Segment Media Buffer Preload is used, and the buffer preload started.

6.4.4.3.1 Enter the state 'G: MB_Taken'

When entering this state the PoC Server:

1. SHALL send a MBCP Media Burst Granted message to the requesting PoC Client, unless any of the following conditions are fulfilled:
 - a. Limited Segment Media Buffer Preload is used; or,
 - b. Local Granted Mode is used; or,
 - c. for the first Media Burst grant when SDP parameter *tb_granted* set to 1 is negotiated and when the PoC Server performing the Participating PoC Function of PoC Enabler Release 2.0 or later has not indicated as specified in [OMA-PoC-CP] "*Back to back UA uri-parameter*" to act as a back to back UA and to stay on the Media path,

NOTE: A PoC Server performing the Participating PoC Function of PoC Enabler Release 1.0 is not able to indicate, if it acts as a back to back UA and stays on the Media path and therefore the TBCP Talk Burst Granted message is sent.

The MBCP Media Burst Granted message:

- i. MAY include notification of the number of Participants connected to the Media-floor Control Entity;
- ii. SHOULD include Alert Margin for Advanced Revocation Alert in case Continuous Media is bound to the Media-floor Control Entity; and,
- iii. SHALL include information in the stop talking time field;
 1. the value of T2 (Stop Talking) timer if only Continuous Media is bound to the Media-floor Control Entity; or,
 2. the value of T18 (end of Media-floor time) if Discrete Media is bound to the Media-floor Control Entity.
2. SHALL start the T20 (Granted re-send) if the PoC Client was queued and if the PoC Client negotiated "queuing";

3. SHALL send MBCP Media Burst Taken message to all other PoC Clients;

MBCP Media Burst Taken message:

- a. SHALL include the identity of the PoC User that has been given permission to send a Media Burst as specified in subclause 8.2 "*Sender Identification*";
 - b. SHALL include the SSRC of the PoC Client granted a permission to send a Media Burst, if known by the PoC Server, or alternatively;
 - c. SHALL have the SSRC of the PoC Client granted a permission to send a Media Burst field all 32 bits set to '1';
 - d. SHALL include Privacy as specified in the subclause 6.5.2.1 "*MBCP specific fields*", if privacy is requested;
 - e. MAY include notification of the number of Participants connected to the Media-floor Control Entity; and,
 - f. MAY include Anonymous identity as specified in subclause 6.5.2.1 "*MBCP specific fields*", if privacy is requested.
4. SHALL start the timer T1 (end of RTP Media timer) in the case Continuous Media is bound to the Media-floor Control Entity;
 5. SHALL start the T19 (start of MSRP) in the case only Discrete Media is bound to the Media-floor Control Entity;
 6. SHALL start the T18 (end of Media-floor time) in the case Discrete Media is bound to the Media-floor Control Entity; and,
 7. SHALL set the general state to 'G: MB_Taken' state.

6.4.4.3.2 T1 (End of RTP Media) timer fired

On expiry of the T1 (End of RTP Media) timer, the PoC Server

1. unless using Limited Segment Media Buffer Preload and in the preload phase,
 - a. SHALL stop the T2 (Stop talking) timer or the T18 (end of Media-floor time); if the timer is running;
 - b. SHALL stop the T20 (Granted re-send) timer, if running; and,
 - c. If the PoC Server does not have Media packets in the buffer the PoC Server
 - i. SHALL perform the actions specified in the subclause 6.4.4.2.1 "*Enter the 'G: MB_Idle state'*".
 - d. Otherwise the PoC Server:
 - i. SHALL perform the actions specified in the subclause 6.4.4.8.1 "*Enter the 'G: pending MB_Idle state'*".
2. Otherwise the PoC Server SHALL remain in the G: MB_Taken state.

6.4.4.3.3 T2 (Stop talking) timer fired

On expiry of the T2 (Stop talking) timer the PoC Server:

1. SHALL stop the T1 (End of RTP Media) timer;
2. SHALL set the reason code field in the MBCP Media Burst Revoke message to 'Media Burst too long' and,
3. SHALL perform the actions specified in the subclause 6.4.4.5.1 "*Enter the 'G: pending MB_Revoke' state'*".

6.4.4.3.4 Receive RTP Media packets (R: Media from permitted client)

Upon receiving RTP Media packets with payload from the permitted PoC Client the PoC Server:

1. SHALL start the T2 (Stop talking) timer if not already running in case only Continuous Media is bound to the Media-floor Control Entity;
2. SHALL either
 - a. forward the received RTP Media packets towards either

NOTE 1: This also applies when already buffered RTP Media packets are to be sent.

- i. all other PoC Clients that are not on hold, if the PoC Session is neither a 1-many-1 PoC Group Session nor a Dispatch PoC Session and PoC Media Traffic Optimisation has not been negotiated and if the PoC Server does not have Media packets in the Media buffer;
- or,
- ii. all PoC Clients that are not on hold whose SIP Sessions are selected for Media transmission from the PoC Server performing the Controlling PoC Function to the PoC Server performing the Participating PoC Function, if the PoC Session is neither a 1-many-1 PoC Group Session nor a Dispatch PoC Session and PoC Media Traffic Optimisation has been negotiated and if the PoC Server does not have Media packets in the Media buffer;
 - iii. all Ordinary Participants or PoC Fleet Members that are not on hold, if the PoC Session is a 1-many-1 PoC Group Session or a Dispatch PoC Session, respectively, and the RTP Media packets are from the Distinguished Participant or the Active PoC Dispatcher sending Media and if the PoC Server does not have Media packets in the Media buffer;
- or,
- iv. the Distinguished Participant or the Active PoC Dispatcher, if the PoC Session is a 1-many-1 PoC Group Session or a Dispatch PoC Session, respectively, and the RTP Media packets are from an Ordinary Participant or a PoC Fleet Member sending Media, and the Distinguished Participant or Active PoC Dispatcher is not on hold and if the PoC Server does not have Media packets in the Media buffer.

NOTE 2: Notice that both 1-many-1 PoC Group Sessions and Dispatch PoC Sessions use the 1-many-1 communication method, so for User Plane sending and receiving Media procedures, the Active PoC Dispatcher is equivalent to the Distinguished Participant and the PoC Fleet Members are equivalent to the Ordinary Participants.

or,

- b. buffer the received RTP Media packets in case of unconfirmed indication and if RTP Media packet buffering is ongoing or if Limited Segment Media Buffer Preload is ongoing and if the PoC Server is in the preload phase.
3. SHALL restart the T1 (End of RTP Media) timer;
4. SHALL stop the T20 (Granted re-send) timer, if running; and,
5. SHALL remain in the 'G: MB_Taken' state.

6.4.4.3.5 Receive MBCP Media Burst Release message (R: MB_Release)

Upon receiving a MBCP Media Burst Release message and,

1. if Continuous Media is bound to the Media-floor Control Entity and the sequence number is not marked as invalid and last RTP Media packet is not received, then the PoC Server:

- a. SHALL store the sequence number of the last RTP Media packet indicated in the message;
 - b. SHALL stop the T20 (Granted re-send) timer, if running; and,
 - c. SHALL perform the actions specified in subclause 6.4.4.4.1 "*Enter the state 'G: pending MB_Release'*".
2. If Continuous Media is bound to the Media-floor Control Entity and the sequence number is not marked as invalid and last RTP Media packet is already received, then the PoC Server:
- a. SHALL stop the T2 (Stop talking) timer, if the timer is running;
 - b. SHALL stop the T20 (Granted re-send) timer, if running; and,
 - c. SHALL either
 - i. perform the actions specified in subclause 6.4.4.8.1 "*Enter the state 'G: pending MB_Idle'*" if RTP Media packet buffering is ongoing;
 - or,
 - ii. perform the actions specified in the subclause 6.4.4.2.1 "*Enter the 'G: MB_Idle state'*" if RTP Media packet buffering is not ongoing.
3. If Continuous Media is bound to the Media-floor Control Entity and the sequence number is marked as invalid, then the PoC Server:
- a. SHALL stop the T2 (Stop talking) timer; if the timer is running;
 - b. SHALL stop the T20 (Granted re-send) timer, if running; and,
 - c. SHALL
 - i. perform the actions specified in subclause 6.4.4.8.1 "*Enter the state 'G: pending MB_Idle'*" if RTP Media packet buffering is ongoing;
 - or,
 - ii. perform the actions specified in the subclause 6.4.4.2.1 "*Enter the 'G: MB_Idle state'*" if RTP Media packet buffering is not ongoing.
4. If only Discrete Media is bound to the Media-floor Control Entity and
- a. if the last chunk of an MSRP SEND request is not received, then the PoC Server:
 - i. SHALL stop the T20 (Granted re-send) timer, if running; and,
 - ii. SHALL perform the actions specified in subclause 6.4.4.4.1 "*Enter the state 'G: pending MB_Release'*";
 - or,
 - b. if there no outstanding chunks of an MSRP SEND request then the PoC Server:
 - i. SHALL stop the T18 (end of Media-floor time), if the timer is running;
 - ii. SHALL stop the T20 (Granted re-send) timer, if running; and,
 - iii. SHALL perform the actions specified in the subclause 6.4.6.2.1 "*Enter the 'G: MB_Idle state'*".

6.4.4.3.6 Receive MBCP Media Burst Request message with pre-emptive priority (R: MB_Request (pre-emptive))

NOTE 1: This procedure is invoked from the subclause 6.4.5.2.3 "*Receive MBCP Media Burst Request message (R: MB_Request)*".

If the PoC Client negotiated "tb_priority", on receipt of a MBCP Media Burst Request message with the request priority level equal to pre-emptive priority, and if the priority level of the PoC Client with permission to send a Media Burst is not the pre-emptive priority, the PoC Server:

1. SHALL stop the T1 (End of RTP Media) timer or stop the T19 (start of MSRP) timer if any of the timers are running;
2. SHALL stop the T20 (Granted re-send) timer, if running; and,
3. SHALL set the reason code field in the MBCP Media Burst Revoke message to 'Media Burst pre-empted';
4. SHALL perform the actions described in the subclause 6.4.4.5.1 "*Enter the 'G: pending MB_Revoke' state*";
5. SHALL insert the PoC Client into the Media Burst request queue to the position in front of all queued requests, if not inserted yet or update the position of the PoC Client in the Media Burst request queue to the position in front of all other queued requests, if already inserted;
6. SHALL send a MBCP Media Burst Request Queue Status message to the requesting PoC Client, if negotiated "queuing".

The MBCP Media Burst Request Queue Status message:

- a. SHOULD indicate the position of the PoC Client in the Media Burst request queue; and,
 - b. MAY indicate the priority level of the PoC Client in the in the Media Burst request queue.
7. SHOULD send a MBCP Media Burst Request Queue Status message with the updated status to the PoC Clients in the Media Burst request queue which negotiated "queuing", which have requested the queue status, whose queue position has been changed since the previous MBCP Media Burst Request Queue Status message and which are not the requesting PoC Client.

The MBCP Media Burst Request Queue Status message:

- a. SHOULD indicate the position of the PoC Client in the Media Burst request queue; and,
- b. MAY indicate the priority level of the PoC Client in the Media Burst request queue.

6.4.4.3.7 Receive MBCP Media Burst Request message from permitted PoC Client (R: MB_Request)

Upon receiving a MBCP Media Burst Request message from the PoC Client that has been granted permission to send a Media Burst the PoC Server:

1. SHALL, unless Limited Segment Media Buffer Preload is used and in the preload phase, send a MBCP Media Burst Granted message to the previously granted PoC Client.

The MBCP Media Burst Granted message:

- a. MAY include notification of the number of Participants connected to the Media-floor Control Entity;
- b. SHOULD include Alert Margin for Advanced Revocation Alert in the case Continuous Media is bound to the Media-floor Control Entity; and,
- c. SHALL include information about the T2 (Stop talking) timer, which MAY be reduced by the PoC Server as follows:

- i. the value of T2 (Stop Talking) timer if only Continuous Media is bound to the Media-floor Control Entity; or,
- ii. the value of T18 (end of Media-floor time) if Discrete Media is bound to the Media-floor Control Entity.

2. SHALL remain in the 'G: MB_Taken' state.

6.4.4.3.8 Sending buffered Media packets (S: Buffered Media)

As long as the PoC Server has RTP Media packets buffered the PoC Server SHALL apply the procedures in the subclause 7.8 "Media buffering".

The PoC Server:

1. SHALL either
 - a. forward the buffered RTP Media packets towards the other PoC Clients that are not on hold, if the PoC Session is neither a 1-many-1 PoC Group Session nor a Dispatch PoC Session or if the Distinguished Participant in case of a 1-many-1 PoC Group Session or the Active PoC Dispatcher in case of a Dispatch PoC Session is sending Media;

or,

 - b. forward the buffered RTP Media packets towards the Distinguished Participant or towards the Active PoC Dispatcher, if the PoC Session is a 1-many-1 PoC Group Session or a Dispatch PoC Session, respectively, and if the Distinguished Participant or the Active PoC Dispatcher is not on hold.

NOTE: Notice that both 1-many-1 PoC Group Sessions and Dispatch PoC Sessions use the 1-many-1 communication method, so for User Plane sending and receiving Media procedures, the Active PoC Dispatcher is equivalent to the Distinguished Participant and the PoC Fleet Members are equivalent to the Ordinary Participants.

2. SHALL remain in the 'G: MB_Taken' state.

6.4.4.3.9 Congestion exists

If congestion detected, as defined in subclause 7.7 "Media Transfer", the PoC Server:

NOTE: Congestion detection is optional.

1. SHALL stop the T1 (End of RTP Media) timer or the T19 (start of MSRP) timer if any of the timers are running;
2. SHALL stop the T20 (Granted re-send) timer, if running;
3. SHALL set the reason code field in the MBCP Media Burst Revoke message to 'No resources available; and,
4. SHALL perform the actions described in the subclause 6.4.4.5.1 "Enter the 'G: pending MB_Revoke' state".

6.4.4.3.10 Preload finished

When Limited Segment Media Buffer Preload is used, and the PoC Server determines that the preload phase has finished, the PoC Server:

NOTE: The PoC Server determines that the preload phase has finished according to local policy. For example this event might be triggered from the Control Plane when the first Confirmed Indication from an Invited PoC Client is received.

1. SHALL send a MBCP Media Burst Granted message to the requesting PoC Client;

The MBCP Media Burst Granted message:

- a. MAY include notification of the number of Participants connected to the Media-floor Control Entity;
 - b. SHOULD include Alert Margin for Advanced Revocation Alert if Continuous Media is bound to the Media-floor Control; and,
 - c. SHALL include in the stop talking time field:
 - i. the value of T2 (Stop Talking) timer if only Continuous Media is bound to the Media-floor Control Entity; or,
 - ii. the value of T18 (end of Media-floor time) if Discrete Media is bound to the Media-floor Control Entity.
2. SHALL start the timer T1 (end of RTP Media timer); and,
 3. SHALL remain in the 'G: MB_Taken' state.

6.4.4.3.11 T19 (start of MSRP) timer fires

At expiry of the T19 (start of MSRP) timer the PoC Server:

1. SHALL stop the T20 (Granted re-send) timer, if running; and,
2. SHALL perform the actions specified in the subclause 6.4.4.2.1 "*Enter state 'G: MB_Idle'*".

6.4.4.3.12 MSRP SEND request received (R: MSRP SEND)

Upon receiving an MSRP SEND request from the PoC Client with the permission to occupy the Media-floor the PoC Server:

1. SHALL stop the T19(start of MSRP) timer if running;
2. SHALL generate and send an MSRP 200 "OK" response according to rules and procedures of [OMA-PoC-IM];
3. SHALL generate an MSRP SEND request according to rules and procedures of [OMA-PoC-IM];
4. SHALL send the MSRP SEND request towards:
 - a. all other PoC Clients that are not on hold and whose maximum allowed message size is greater or equal to the size of the content in the received MSRP SEND request, if the PoC Session is neither a 1-many-1 PoC Group Session nor a Dispatch PoC Session;or,
 - b. all Ordinary Participants or PoC Fleet Members that are not on hold and whose maximum allowed message size is greater or equal to the size of the content in the received MSRP SEND request, if the PoC Session is a 1-many-1 PoC Group Session or a Dispatch PoC Session, respectively, and the MSRP SEND request are from the Distinguished Participant or the Active PoC Dispatcher sending Media;or,
 - c. the Distinguished Participant or the Active PoC Dispatcher, and whose maximum allowed message size is greater or equal to the size of the content in the received MSRP SEND request, if the PoC Session is a 1-many-1 PoC Group Session or a Dispatch PoC Session, respectively, the MSRP SEND request are from an Ordinary Participant or a PoC Fleet Member sending Media, and the Distinguished Participant or Active PoC Dispatcher is not on hold;

NOTE: Notice that both 1-many-1 PoC Group Sessions and Dispatch PoC Sessions use the 1-many-1 communication method, so for User Plane sending and receiving Media procedures, the Active PoC Dispatcher is equivalent to the Distinguished Participant and the PoC Fleet Members are equivalent to the Ordinary Participants.

5. SHALL stop the T20 (Granted re-send) timer, if running; and,
6. SHALL remain in the 'M: MB_Taken' state.

6.4.4.3.13 T18 (end of Media-floor time) timer fire

When the timer T18 (end of Media-floor time) fires the PoC Server:

1. SHALL stop the T1 (End of RTP Media) timer or the T19 (start of MSRP) timer if any of the timers are running;
2. SHALL stop the T20 (Granted re-send) timer, if running;
3. SHALL set the reason code field in the MBCP Media Burst Revoke message to 'Media Burst too long' if Continuous Media is bound to the Media-floor Control Entity;
4. SHALL set the reason code field in the MBCP Media Burst Revoke message to 'Media-floor occupied too long' if only Discrete Media is bound to the Media-floor Control Entity; and,
5. SHALL perform the actions specified in the subclause 6.4.4.5.1 "*Enter the 'G: pending MB_Revoke' state*".

6.4.4.3.14 T20 (Granted re-send) timer fired

On expiry of the T20 (Granted re-send) timer, the PoC Server:

1. SHALL send a MBCP Media Burst Granted message to the granted PoC Client;

The MBCP Media Burst Granted message:

- a. MAY include notification of the number of Participants connected to the Media-floor Control Entity;
- b. SHOULD include Alert Margin for Advanced Revocation Alert in case Continuous Media is bound to the Media-floor Control Entity; and,
- c. SHALL include information in the stop talking time field;
 - i. the value of T2 (Stop Talking) timer if only Continuous Media is bound to the Media-floor Control Entity; or,
 - ii. the value of T18 (end of Media-floor time) if Discrete Media is bound to the Media-floor Control Entity.
2. SHALL start the T20 (Granted re-send) timer; and
3. SHALL remain in the 'G: MB_Taken' state.

6.4.4.3.15 T20 (Granted re-send) timer fired N times

On the N:th expiry of the T20 (Granted re-send) timer, the PoC Server:

1. SHALL remain in the 'G: MB_Taken' state.

6.4.4.4 State 'G: pending MB_Release'

The 'G: pending MB_Release' state is a transition state and the PoC Server uses this state after having received a MBCP Media Burst Release message from the permitted PoC Client.

The T1 (End of RTP) timer is running when the PoC Server is in this state if Continuous Media is bound to the Media-floor Control Entity.

The T18 (end of Media-floor) timer can be running in this state if only Discrete Media is bound to the Media-floor Control Entity.

6.4.4.4.1 Enter the state 'G: pending MB_Release'

When entering this state the PoC Server:

1. SHALL set the general state to 'G: pending MB_Release'.

6.4.4.4.2 Receive last RTP Media packets (R: Last Media)

Upon receiving a RTP Media packet from the permitted PoC Client with the same (or higher) sequence number as indicated in the MBCP Media Burst Release message the PoC Server:

1. SHALL stop the T2 (Stop talking) timer, if the timer is running;
2. SHALL either
 - a. forward the received last RTP Media packet to all other PoC Clients that are not on hold, if the PoC Session is neither a 1-many-1 PoC Group Session nor a Dispatch PoC Session and PoC Media Traffic Optimisation has not been negotiated or the Distinguished Participant in case of a 1-many-1 PoC Group Session or the Active PoC Dispatcher in case of a Dispatch PoC Session is sending Media and if the PoC Server does not have RTP Media packets in the Media buffer;
 - or,
 - b. forward the received last RTP Media packet to all PoC Clients that are not on hold whose SIP Sessions are selected for Media transmission from the PoC Server performing the Controlling PoC Function, if the PoC Session is neither a 1-many-1 PoC Group Session nor a Dispatch PoC Session and PoC Media Traffic Optimisation has been negotiated, if the PoC Server does not have RTP Media packets in the Media buffer;
 - or,
 - c. forward the received last RTP Media packet towards the Distinguished Participant or towards the Active PoC Dispatcher, if the PoC Session is a 1-many-1 PoC Group Session or a Dispatch PoC Session, respectively, and the Distinguished Participant or the Active PoC Dispatcher is not on hold if the PoC Server does not have RTP Media packets in the Media buffer.

NOTE: Notice that both 1-many-1 PoC Group Sessions and Dispatch PoC Sessions use the 1-many-1 communication method, so for User Plane sending and receiving Media procedures, the Active PoC Dispatcher is equivalent to the Distinguished Participant and the PoC Fleet Members are equivalent to the Ordinary Participants.

3. SHALL either
 - a. perform the actions specified in subclause 6.4.4.8.1 "*Enter the state 'G: pending MB_Idle'*" if RTP Media packet buffering is ongoing;
 - or,
 - b. perform the actions specified in the subclause 6.4.4.2.1 "*Enter the 'G: MB_Idle state'*" if RTP Media packet buffering is not ongoing.

6.4.4.4.3 Receive RTP Media packets (R: Media)

Upon receiving a RTP Media packet with payload from the permitted PoC Client with a sequence number lower than the sequence number indicated in the MBCP Media Burst Release message the PoC Server:

1. SHALL either
 - a. forward the received RTP Media packets to all other PoC Clients that are not on hold, if the PoC Session is neither a 1-many-1 Session nor a Dispatch PoC Session and PoC Media Traffic Optimisation has not been negotiated or if the Distinguished Participant in case of a 1-many-1 PoC Group Session or the Active PoC

Dispatcher in case of a Dispatch PoC Session is sending Media and if the PoC Server does not have RTP Media packets in the Media buffer;

or,

- b. forward the received RTP Media packets to all other PoC Clients that are not on hold whose SIP Sessions are selected for Media transmission from the PoC Server performing the Controlling PoC Function to the PoC Server performing the Participating PoC Function, if the PoC Session is neither a 1-many-1 PoC Group Session nor a Dispatch PoC Session and PoC Media Traffic Optimisation has been negotiated and if the PoC Server does not have RTP Media packets in the Media buffer;

or,

- c. forward the received RTP Media packets towards the Distinguished Participant or towards the Active PoC Dispatcher, if the PoC Session is a 1-many-1 PoC Group Session or a Dispatch PoC Session, respectively, and the RTP Media packets are from an Ordinary Participant or from a PoC Fleet Member sending Media and the Distinguished Participant or Active PoC Dispatcher is not on hold and if the PoC Server does not have RTP Media packets in the Media buffer;

NOTE: Notice that both 1-many-1 PoC Group Sessions and Dispatch PoC Sessions use the 1-many-1 communication method, so for User Plane sending and receiving Media procedures, the Active PoC Dispatcher is equivalent to the Distinguished Participant and the PoC Fleet Members are equivalent to the Ordinary Participants.

- d. buffer the received RTP Media packets in case of unconfirmed indication and if RTP Media packet buffering is ongoing or if Limited Segment Media Buffer Preload is ongoing and if the PoC Server is in the preload phase.

2. SHALL restart the T1 (End of RTP Media) timer; and,

3. SHALL remain in the 'G: pending MB_Release' state.

6.4.4.4.4 T1 (End of RTP Media) timer fired

On expiry of the T1 (End of RTP Media) timer the PoC Server:

1. SHALL stop the T2 (Stop talking) timer, if the timer is running; and,
2. SHALL either:
 - a. perform the actions specified in subclause 6.4.4.8.1 "*Enter the state 'G: pending MB_Idle'*" if RTP Media packet buffering is ongoing;

or,

 - b. perform the actions specified in the subclause 6.4.4.2.1 "*Enter the 'G: MB_Idle state'*" if RTP Media packet buffering is not ongoing.

6.4.4.4.5 T2 (Stop talking) timer fired

On expiry of the T2 (Stop talking) timer the PoC Server:

1. SHALL perform the actions specified in the subclause 6.4.4.2.1 "*Enter the 'G: MB_Idle state'*".

NOTE: When the PoC Client is a PoC release version 1.0 PoC Client the PoC Server performs the actions specified in [OMA-PoC-1-UP] "*Enter the G: pending MB_Revoke' state'*".

6.4.4.4.6 Sending buffered Media packets (S: Buffered Media)

As long as the PoC Server has RTP Media packets buffered the PoC Server SHALL apply the procedures in the subclause 7.8 "*Media buffering'*".

The PoC Server:

1. SHALL either
 - a. forward the buffered RTP Media packets towards the other PoC Clients that are not on hold, if the PoC Session is neither a 1-many-1 PoC Group Session nor a Dispatch PoC Session or if the Distinguished Participant in case of a 1-many-1 PoC Group Session or the Active PoC Dispatcher in case of a Dispatch PoC Session is talking;
 - or,
 - b. forward the buffered RTP media packets towards the Distinguished Participant or towards the Active PoC Dispatcher, if the PoC Session is a 1-many-1 PoC Group Session or a Dispatch PoC Session, respectively, and if the Distinguished Participant or the Active PoC Dispatcher is not on hold.

NOTE: Notice that both 1-many-1 PoC Group Sessions and Dispatch PoC Sessions use the 1-many-1 communication method, so for User Plane sending and receiving Media procedures, the Active PoC Dispatcher is equivalent to the Distinguished Participant and the PoC Fleet Members are equivalent to the Ordinary Participants.

2. SHALL remain in the 'G: pending MB_Release' state.

6.4.4.4.7 Receive last chunk in a MSRP SEND request (R: Last MSRP SEND)

Upon receiving the last chunk in a MSRP SEND request from the permitted PoC Client the PoC Server:

1. SHALL stop the T18 (end of Media-floor time) timer, if the timer is running;
2. SHALL generate and send an MSRP 200 "OK" response according to rules and procedures of [OMA-PoC-IM]; and,
3. either
 - a. SHALL forward the received MSRP SEND request to all other PoC Clients that are not on hold, if the PoC Session is neither a 1-many-1 PoC Group Session nor a Dispatch PoC Session or if the Distinguished Participant in case of a 1-many-1 PoC Group Session or the Active PoC Dispatcher in case of a Dispatch PoC Session is talking;
 - or,
 - b. SHALL forward the received MSRP SEND request towards the Distinguished Participant or towards the Active PoC Dispatcher, if the PoC Session is a 1-many-1 PoC Group Session or a Dispatch PoC Session, respectively.

NOTE: Notice that both 1-many-1 PoC Group Sessions and Dispatch PoC Sessions use the 1-many-1 communication method, so for User Plane sending and receiving Media procedures, the Active PoC Dispatcher is equivalent to the Distinguished Participant and the PoC Fleet Members are equivalent to the Ordinary Participants.

4. SHALL perform the actions specified in the subclause 6.4.4.2.1 "Enter the 'G: MB_Idle state'".

6.4.4.4.8 MSRP SEND request (R: MSRP SEND)

Upon receiving a MSRP SEND request from the permitted PoC Client with a sequence number lower than the sequence number of the last chunk the PoC Server:

1. SHALL generate and send an MSRP 200 "OK" response according to rules and procedures of [OMA-PoC-IM];
2. either
 - a. SHALL forward the MSRP SEND request to all other PoC Clients that are not on hold, if the PoC Session is neither a 1-many-1 PoC Group Session nor a Dispatch PoC Session or the Distinguished Participant in

case of a 1-many-1 PoC Group Session or the Active PoC Dispatcher in case of a Dispatch PoC Session is talking;

or,

- b. SHALL forward the received MSRP SEND request towards the Distinguished Participant or towards the Active PoC Dispatcher, if the PoC Session is a 1-many-1 PoC Group Session or a Dispatch PoC Session, respectively;

NOTE: Notice that both 1-many-1 PoC Group Sessions and Dispatch PoC Sessions use the 1-many-1 communication method, so for User Plane sending and receiving Media procedures, the Active PoC Dispatcher is equivalent to the Distinguished Participant and the PoC Fleet Members are equivalent to the Ordinary Participants.

3. SHALL remain in the 'G: pending MB_Release' state.

6.4.4.4.9 T18 (end of Media-floor time) timer fired

On expiry of the T18 (end of Media-floor time) timer the PoC Server:

1. SHALL perform the actions specified in the subclause 6.4.4.5.1 "*Enter the 'M: pending MB_Revoke' state*".

6.4.4.5 State 'G: pending MB_Revoke'

The 'G: pending MB_Revoke' state is a transition state and the PoC Server uses this state after having sent a MBCP Media Burst Revoke message to the permitted PoC Client.

The timer T3 (Stop talking grace) is running when the PoC Server use this state.

In this state the PoC Server forwards RTP Media packets or MSRP SEND messages to other PoC Clients.

6.4.4.5.1 Enter the 'G: pending MB_Revoke' state

When entering this state the PoC Server:

1. SHALL send the MBCP Media Burst Revoke message to the permitted PoC Client.

The MBCP Media Burst Revoke message:

- a. SHALL include a reason code field; and,
- b. SHALL include a reason phrase.

NOTE: The value of the reason code field depends on why the permission to send a Media Burst is revoked and is described elsewhere in this document.

2. SHALL start the T3 (Stop talking grace) timer; and,
3. SHALL set the general state to 'G: pending MB_Revoke'.

6.4.4.5.2 Receive RTP Media packets (R: Media)

Upon receiving RTP Media packets with payload and with a sequence number lower than the sequence number indicated in the MBCP Media Burst Release message the PoC Server:

NOTE 1: The sequence number of the last RTP Media packet is received in the MBCP Media Burst Release message. Prior to the receipt of the MBCP Media Burst Release message all RTP Media packets are regarded to not be the last RTP Media packet.

1. SHALL either

- a. forward the received RTP Media packets towards the other PoC Clients that are not on hold, if the PoC Session is neither a 1-many-1 PoC Group Session nor a Dispatch PoC Session and PoC Media Traffic Optimisation has not been negotiated or if the Distinguished Participant in case of a 1-many-1 PoC Group Session or the Active PoC Dispatcher in case of a Dispatch PoC Session is sending Media and if the PoC Server does not have RTP Media packets in the Media buffer;
- or,
- b. forward the received RTP Media packets to all PoC Clients that are not on hold whose SIP Sessions are selected for Media transmission from the PoC Server performing the Controlling PoC Function to the PoC Server performing the Participating PoC Function, if the PoC Session is neither a 1-many-1 PoC Group Session nor a Dispatch PoC Session and PoC Media Traffic Optimisation has been negotiated and if the PoC Server does not have RTP Media packets in the Media buffer;
- or,
- c. forward the received RTP Media packets towards the Distinguished Participant or towards the Active PoC Dispatcher, if the PoC Session is a 1-many-1 PoC Group Session or a Dispatch PoC Session, respectively, and the RTP Media packets are from an Ordinary Participant or from a PoC Fleet Member sending Media and the Distinguished Participant or Active PoC Dispatcher is not on hold and if the PoC Server does not have RTP Media packets in the Media buffer;.

NOTE 2: Notice that both 1-many-1 PoC Group Sessions and Dispatch PoC Sessions use the 1-many-1 communication method, so for User Plane sending and receiving Media procedures, the Active PoC Dispatcher is equivalent to the Distinguished Participant and the PoC Fleet Members are equivalent to the Ordinary Participants.

or,

- d. buffer the received RTP Media packets in case of unconfirmed indication and if RTP Media packet buffering is ongoing or if Limited Segment Media Buffer Preload is ongoing and if the PoC Server is in the preload phase.
2. SHALL restart the T1 (End of RTP Media) timer; and,
 3. SHALL remain in the 'G: pending MB_Revoke' state.

6.4.4.5.3 Receive MBCP Media Burst Release message (R: MB_Release (from permitted PoC Client))

Upon receiving a MBCP Media Burst Release message and,

1. if the sequence number is not marked as invalid and last RTP Media packet is not received, then the PoC Server:
 - a. SHALL store the sequence number of the last RTP Media packet; and,
 - b. SHALL remain in the 'G: pending MB_Revoke' state.
2. or, if the sequence number is not marked as invalid and last RTP Media packet is already received, then the PoC Server:
 - a. SHALL stop the T1 (End of RTP Media) timer if it is running;
 - b. SHALL stop the T3 (Stop talking grace) timer; and,
 - c. SHALL either
 - i. perform the actions specified in subclause 6.4.4.8.1 "Enter the state 'G: pending MB_Idle'" if RTP Media packet buffering is ongoing;

or,

- ii. perform the actions specified in the subclause 6.4.4.2.1 "*Enter the 'G: MB_Idle state'*" if RTP Media packet buffering is not ongoing.
- 3. or, if the sequence number is marked as invalid, then the PoC Server:
 - a. SHALL stop the T1 (End of RTP Media) timer if it is running;
 - b. SHALL stop the T3 (Stop talking grace) timer; and,
 - c. SHALL either
 - i. perform the actions specified in subclause 6.4.4.8.1 "*Enter the state 'G: pending MB_Idle'*" if RTP Media packet buffering is ongoing;
 - or,
 - ii. perform the actions specified in the subclause 6.4.4.2.1 "*Enter the 'G: MB_Idle state'*" if RTP Media packet buffering is not ongoing.
- 4. If only Discrete Media is bound to the Media-floor Control Entity the PoC Server:
 - a. SHALL stop the T3 (Stop talking grace) timer;
 - b. SHALL stop the T19 (start of MSRP) timer if it is running; and,
 - c. SHALL perform the actions in subclause 6.4.4.2.1 "*Enter the 'G: MB_Idle state'*".

6.4.4.5.4 Receive last RTP Media packets (R: Last Media)

Upon receiving a RTP Media packet with payload from the permitted PoC Client with the same (or higher) sequence number as indicated in the MBCP Media Burst Release message the PoC Server:

- 1. SHALL either
 - a. forward the RTP Media packet to all other PoC Clients that are not on hold, if the PoC Session is neither a 1-many-1 PoC Group Session nor a Dispatch PoC Session and PoC Media Traffic Optimisation has not been negotiated or if the Distinguished Participant in case of a 1-many-1 PoC Group Session or the Active PoC Dispatcher in case of a Dispatch PoC Session is sending Media and if the PoC Server does not have RTP Media packets in the Media buffer;
 - or,
 - b. forward the received RTP Media packet to all PoC Clients that are not on hold whose SIP Sessions are selected for Media transmission from the PoC Server performing the Controlling PoC Function to the PoC Server performing the Participating PoC Function, if the PoC Session is neither a 1-many-1 PoC Group Session nor a Dispatch PoC Session and PoC Media Traffic Optimisation has been negotiated and if the PoC Server does not have RTP Media packets in the Media buffer;
 - or,
 - c. forward the received RTP Media packets towards the Distinguished Participant or towards the Active PoC Dispatcher, if the PoC Session is a 1-many-1 PoC Group Session or a Dispatch PoC Session, respectively, if the RTP Media packet has the same sequence number as the sequence number indicated in the MBCP Media Burst Release message and if the PoC Server does not have RTP Media packets in the Media buffer;

NOTE: Notice that both 1-many-1 PoC Group Sessions and Dispatch PoC Sessions use the 1-many-1 communication method, so for User Plane sending and receiving Media procedures, the Active PoC Dispatcher is equivalent to the Distinguished Participant and the PoC Fleet Members are equivalent to the Ordinary Participants.

or,

- d. buffer the received RTP Media packets in case of unconfirmed indication and if RTP Media packet buffering is ongoing or if Limited Segment Media Buffer Preload is ongoing and if the PoC Server is in the preload phase.
- 2. SHALL stop the T1 (End of RTP Media) timer if it is running;
- 3. SHALL stop T3 (Stop talking grace) timer; and,
- 4. SHALL perform the actions specified in the subclause 6.4.4.2.1 "*Enter the 'G: MB_Idle state'*".

6.4.4.5.5 T3 (Stop talking grace) timer fired

On expiry of the T3 (Stop talking grace) timer the PoC Server:

- 1. SHALL perform the actions specified in the subclause 6.4.4.2.1 "*Enter the 'G: MB_Idle state'*".

6.4.4.5.6 Sending buffered Media packets (S: Buffered Media)

As long as the PoC Server has RTP Media packets buffered the PoC Server SHALL apply the procedures in the subclause 7.8 "*Media buffering'*".

The PoC Server:

- 1. SHALL
 - a. forward the buffered RTP Media packets towards the other PoC Clients that are not on hold, if the PoC Session is neither a 1-many-1 PoC Group Session nor a Dispatch PoC Session or if the Distinguished Participant in case of a 1-many-1 PoC Group Session or the Active PoC Dispatcher in case of a Dispatch PoC Session is talking;
 - or,
 - b. forward the buffered RTP media packets towards the Distinguished Participant or towards the Active PoC Dispatcher, if the PoC Session is a 1-many-1 PoC Group Session or a Dispatch PoC Session, respectively, and if the Distinguished Participant or the Active PoC Dispatcher is not on hold.

NOTE: Notice that both 1-many-1 PoC Group Sessions and Dispatch PoC Sessions use the 1-many-1 communication method, so for User Plane sending and receiving Media procedures, the Active PoC Dispatcher is equivalent to the Distinguished Participant and the PoC Fleet Members are equivalent to the Ordinary Participants.

6.4.4.5.7 MSRP SEND request received (R: MSRP SEND)

Upon receiving an MSRP SEND request from the PoC Client with the permission to occupy the Media-floor the PoC Server:

- 1. SHALL generate and send an MSRP 200 response according to rules and procedures of [OMA-PoC-IM];
- 2. SHALL generate an MSRP SEND request according to rules and procedures of [OMA-PoC-IM];
- 3. SHALL send the MSRP SEND request towards:
 - a. all other PoC Clients that are not on hold and whose maximum allowed message size is greater or equal to the size of the content in the received MSRP SEND request, if the PoC Session is neither a 1-many-1 PoC Group Session nor a Dispatch PoC Session;
 - or,
 - b. all Ordinary Participants or PoC Fleet Members that are not on hold and whose maximum allowed message size is greater or equal to the size of the content in the received MSRP SEND request, if the PoC Session is a 1-many-1 PoC Group Session or a Dispatch PoC Session, respectively, and the MSRP SEND request are from the Distinguished Participant or from the Active PoC Dispatcher sending Media;

or,

- c. the Distinguished Participant or the Active PoC Dispatcher and whose maximum allowed message size is greater or equal to the size of the content in the received MSRP SEND request, if the PoC Session is a 1-many-1 PoC Group Session or a Dispatch PoC Session, respectively, the MSRP SEND request are from an Ordinary Participant or from a PoC Fleet Member sending Media, and the Distinguished Participant or the Active PoC Dispatcher is not on hold;

NOTE: Notice that both 1-many-1 PoC Group Sessions and Dispatch PoC Sessions use the 1-many-1 communication method, so for User Plane sending and receiving Media procedures, the Active PoC Dispatcher is equivalent to the Distinguished Participant and the PoC Fleet Members are equivalent to the Ordinary Participants.

- 4. SHALL remain in the 'M: MB_Taken' state.

6.4.4.6 State: Any state

This subclause describes the actions to be taken in all states defined for the general state diagram with the exception of the 'Start-stop' state.

6.4.4.6.1 Receive PoC Session release - 1 or the Media-floor Control is terminated

This subclause is valid when a PoC Session is released or when the Media-floor Control Entity is terminated.

Upon receiving a PoC Session release stage 1 request from the Control Plane, the PoC Server:

- 1. SHALL stop sending MBTCP messages, MSRP SEND message/responses and RTP Media packets towards all PoC Clients; and,
- 2. SHALL enter the 'Releasing' state.

6.4.4.6.2 PoC Client joins an existing Media-floor Control Entity

When a PoC Client connects to a Media-floor Control Entity the PoC Server:

- 1. SHALL remain in the current state.

6.4.4.6.3 PoC Client leaves an existing Media-floor Control Entity

When a PoC Client disconnects from the Media-floor Control Entity the PoC Server:

- 1. if the PoC Client is the PoC Client that has the permission to send Media the PoC Server:
 - a. SHALL stop all running timers; and,
 - b. SHALL perform the actions in subclause 6.4.4.2.1 "Enter state 'M: MB_Idle'".
- 2. If another PoC Client is the PoC Client that has the permission to send Media the PoC Server:
 - a. SHALL remain in the current state.

6.4.4.7 State: 'Releasing'

The 'Releasing' state is a transition state. The PoC Server uses this state while waiting for the Control Plane to finalize the disconnection of a PoC Session.

6.4.4.7.1 Receive PoC Session release - 2

Upon receiving a PoC Session release stage 2 request from the Control Plane, the PoC Server:

- 1. SHALL release all resources reserved in the User Plane including the instances used for the general state machine, and basic state machines and any running timers associated with the general and basic state machines; and,

2. SHALL enter the 'Start-stop' state and terminate the PoC Session control state machine.

6.4.4.8 State: 'G: pending MB_Idle'

The 'G: pending MB_Idle' state is a transition state. The PoC Server uses this state when buffered RTP Media packets are sent to Participants in the PoC Session before entering the 'G: MB_Idle' state.

This state is optional and only supported if the PoC Server supports RTP Media buffering.

6.4.4.8.1 Enter the state 'G: pending MB_Idle'

When entering this state the PoC Server:

1. SHALL set the general state to 'G: pending MB_Idle'.

6.4.4.8.2 Sending buffered Media packets (S: Buffered Media)

As long as the PoC Server has RTP Media packets buffered the PoC Server SHALL apply the procedures in the subclause 7.8 "Media buffering".

The PoC Server:

1. SHALL
 - a. forward the buffered RTP Media packets towards the other PoC Clients that are not on hold, if the PoC Session is neither a 1-many-1 PoC Group Session nor a Dispatch PoC Session or if the Distinguished Participant in case of a 1-many-1 PoC Group Session or the Active PoC Dispatcher in case of a Dispatch PoC Session is talking;
 - or,
 - b. forward the buffered RTP media packets towards the Distinguished Participant or towards the Active PoC Dispatcher, if the PoC Session is a 1-many-1 PoC Group Session or a Dispatch PoC Session, respectively, and if the Distinguished Participant or the Active PoC Dispatcher is not on hold.

NOTE: Notice that both 1-many-1 PoC Group Sessions and Dispatch PoC Sessions use the 1-many-1 communication method, so for User Plane sending and receiving Media procedures, the Active PoC Dispatcher is equivalent to the Distinguished Participant and the PoC Fleet Members are equivalent to the Ordinary Participants.

2. SHALL
 - a. remain in the 'pending MB_Idle' state as long as Media packets are buffered;
 - or,
 - b. perform the actions specified in the subclause 6.4.4.8.3 "The last RTP Media packet is sent (S: Last Media in buffer)" when the last buffered Media packet is sent.

6.4.4.8.3 The last RTP Media packet is sent (S: Last Media in buffer)

When the last RTP Media packet is sent the PoC Server:

1. SHALL perform the actions specified in the subclause 6.4.4.2.1 "Enter the 'G: MB_Idle state'".

6.4.5 PoC Server state transition diagram for basic Media Burst operation to the PoC Client

The PoC Server SHALL support the state diagram and the state transitions specified in this subclause when Continuous Media or Discrete Media or both are bound to a Media-floor Control Entity.

NOTE 1: The sending or receiving of reports related to Discrete Media are described in subclauses 7.12 "Discrete Media Transfer Final Report" and 7.13 "Discrete Media Transfer Progress Report".

NOTE 2: In this subclause the sending of MBTCP messages are described, but they are not sent, if they are already sent according to the subclause 6.4.4 "PoC Server state transition diagram for general Media Burst operation".

NOTE 3: The optional MBTCP features "queuing" and "tb_priority" are specified in [OMA-PoC-CP] "Media Burst Control Protocol MIME registration".

Figure 12 "PoC Server state transition diagram for normal Media Burst operation to the PoC Client" shows the states and state transitions for Media Burst Control for a specific PoC User (U states) in the PoC Server.

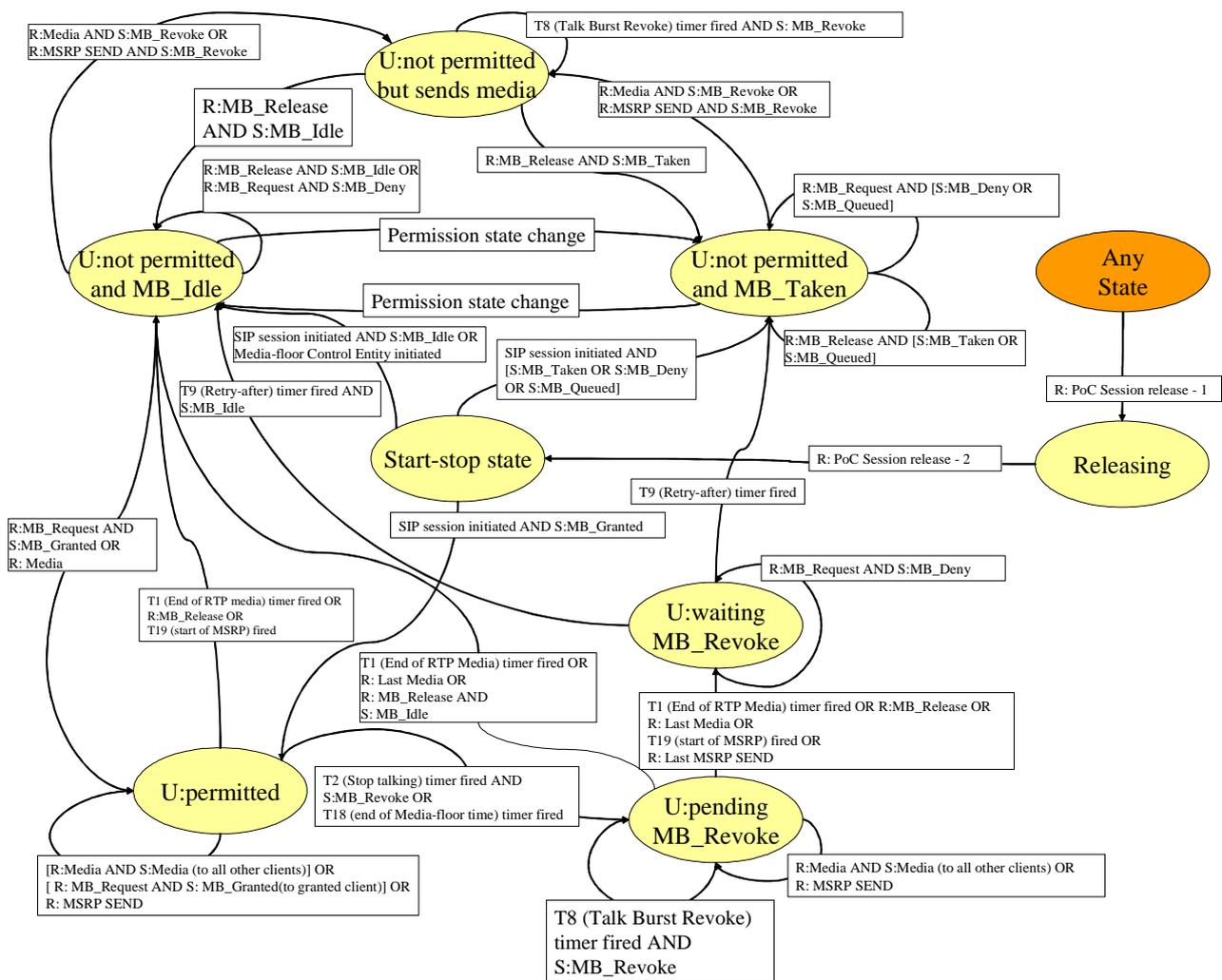

Figure 12: PoC Server state transition diagram for normal Media Burst operation to the PoC Client

The PoC Server SHALL create one instance of the state machine for every PoC Client served by the PoC Server, when the PoC Session is established, as follows:

In case of an originating PoC Client, the PoC Session SHALL be established when the PoC Server sends the SIP 200 "OK" response to the originating PoC Client.

NOTE 4: The originating PoC Client might receive a MBCP message before the SIP 200 "OK" response, because of processing delays of the SIP 200 "OK" in the SIP/IP Core.

In case of a terminating PoC Client, the PoC Session SHALL be established when the PoC Server receives the SIP 200 "OK" response sent from the terminating PoC Client.

The PoC Client associated to the PoC Server state transition diagram for basic Media Burst operation to the PoC Client is here referred to as the associated PoC Client.

State details are explained in the following subclauses.

If a MBCP message, a MSRP message or a RTP Media packet arrives in any state and there is no procedure specified for it in the subclauses below the PoC Server SHALL discard the MBCP message, the MSRP message or the RTP Media packet and SHALL remain in the current state.

When the PoC Server negotiates with the PoC Client the Talk Burst Control Protocol as specified in [OMA-PoC-1-UP] instead of the Media Burst Control Protocol, the PoC Server:

1. SHALL handle the TBCP message received from the PoC Client as the MBCP message of the same subtype; and,
2. SHALL generate and send towards the PoC Client in the subclauses below the TBCP message instead of the MBCP message as follows:
 - a. the TBCP message of the same subtype is generated; and,
 - b. the TBCP message fields with the same content are included into the TBCP message.

6.4.5.1 State 'Start-stop'

In this state no association exists between the PoC Server and a PoC Client exists.

An association between the PoC Server and the PoC Client can be created when a PoC Session is initiated or during a PoC Session.

6.4.5.1.1 SIP Session initiated

When a SIP Session is established and:

1. if the associated PoC Client initiates a PoC Session with an Implicit Media Burst Request, and the PoC Session does not exist yet, the PoC Server:
 - a. SHALL continue to perform the actions in subclause 6.4.4.1.1 "*PoC Session initialization*"; and,
 - b. SHALL perform the actions specified in the subclause 6.4.5.4.1 "*Enter the state 'U: permitted' state*" if a PoC Session is initiated by the associated PoC Client;
2. if the associated PoC Client rejoins an ongoing PoC Session without an Implicit Media Burst Request or initiates or joins a Chat PoC Group Session without an Implicit Media Burst Request or attempts to initiate an already existing PoC Session without an Implicit Media Burst Request, and
 - if a PoC Session already exists but no PoC Client has the permission to send a Media Burst, the PoC Server:
 - a. SHOULD send a MBCP Media Burst Idle message to the PoC Client; and,
 - b. SHALL perform the actions specified in the subclause 6.4.5.4.1 "*Enter the state 'U: not permitted and MB_Idle' state*".
 - if a PoC Session is initiated, the PoC Server:
 - c. SHALL perform the actions specified in the subclause 6.4.5.4.1 "*Enter the state 'U: not permitted and MB_Idle' state*"; and,

d. SHALL continue to perform actions in subclause 6.4.4.1.1 "*PoC Session initialization*".

if another PoC Client has the permission to send a Media Burst, the PoC Server:

e. SHOULD send a MBCP Media Burst Taken message to the PoC Client;

The MBCP Media Burst Taken message:

- i. SHALL include the identity of the PoC User that has been given permission to send a Media Burst as specified in subclause 8.2 "*Sender Identification*";
- ii. SHALL include the SSRC of the PoC Client granted a permission to send a Media Burst, if known by the PoC Server, or alternatively;
- iii. SHALL have the SSRC of the PoC Client granted a permission to send a Media Burst field all 32 bits set to '1';
- iv. SHALL include Privacy as specified in the subclause 6.5.2.1 "*MBCP specific fields*", if privacy is requested;
- v. MAY include notification of the number of Participants connected to the Media-floor Control Entity; and,
- vi. MAY include Anonymous identity as specified in subclause 6.5.2.1 "*MBCP specific fields*", if privacy is requested.

f. SHALL perform the actions specified in the subclause 6.4.5.3.1 "*Enter the 'U: not permitted and MB_Taken' state*".

3. if the associated PoC Client attempts to initiate an already existing PoC Session with an Implicit Media Burst Request, and

a. if no PoC Client has the permission to send a Media Burst, the PoC Server:

- i. SHALL perform the actions in the subclause 6.4.4.2.2 "*Receive MBCP Media Burst Request message (R: MB_Request)*"; and,
- ii. SHALL perform the actions specified in the subclause 6.4.5.4.1 "*Enter the state 'U: permitted'*";

b. if the PoC Client negotiated "queuing" and if another PoC Client has the permission to send a Media Burst, the PoC Server:

- i. SHALL set the priority level to the negotiated maximum priority level that the PoC Client is permitted to request, except for pre-emptive priority, when high priority is used;

NOTE: The initial implicit MB_Request will not result in pre-emption, when a PoC Client is joining an ongoing PoC Session. If the PoC Uses wants to pre-empt the current PoC Client that are sending Media, an explicit MB_Request with pre-emptive priority is required.

- ii. SHALL insert the PoC Client into the Media Burst request queue to the position immediately following all queued requests at the same priority level;
- iii. SHALL send a MBCP Media Burst Request Queue Status message to the PoC Client.

The MBCP Media Burst Request Queue Status message:

- 1. SHOULD indicate the position of the PoC Client in the Media Burst request queue; and,
- 2. MAY indicate the priority level of the PoC Client in the in the Media Burst request queue.

- iii. SHOULD send a MBCP Media Burst Request Queue Status message with the updated status to the PoC Clients in the Media Burst request queue which negotiated "queuing", which have requested the queue status, whose queue position has been changed since the previous MBCP Media Burst Request Queue Status message and which are not the joining PoC Client.

The MBCP Media Burst Request Queue Status message:

- 1. SHOULD indicate the position of the PoC Client in the Media Burst request queue; and,
 - 2. MAY indicate the priority level of the PoC Client in the Media Burst request queue.
- iv. SHOULD send a MBCP Media Burst Taken message to the PoC Client.

The MBCP Media Burst Taken message:

- 1. SHALL include the identity of the PoC User that has been given permission to send a Media Burst as specified in subclause 8.2 "*Sender Identification*";
 - 2. SHALL include the SSRC of the PoC Client granted a permission to send a Media Burst, if known by the PoC Server, or alternatively;
 - 3. SHALL have the SSRC of the PoC Client granted a permission to send a Media Burst field all 32 bits set to '1';
 - 4. SHALL include Privacy as specified in the subclause 6.5.2.1 "*MBCP specific fields*", if privacy requested;
 - 5. MAY include notification of the number of Participants connected to the Media-floor Control Entity; and,
 - 6. MAY include Anonymous identity as specified in subclause 6.5.2.1 "*MBCP specific fields*", if privacy is requested.
- v. SHALL perform the actions described in the subclause 6.4.5.3.1 "*Enter the 'U: not permitted and MB_Taken' state*".
- c. if the PoC Client did not negotiate "queuing" and if another PoC Client has the permission to send a Media Burst, the PoC Server:
 - i. SHALL send a MBCP Media Burst Taken message to the PoC Client

The MBCP Media Burst Taken message:

- 1. SHALL include the identity of the PoC User that has been given permission to send a Media Burst as specified in subclause 8.2 "*Sender Identification*";
- 2. SHALL include the SSRC of the PoC Client granted a permission to send a Media Burst, if known by the PoC Server, or alternatively;
- 3. SHALL have the SSRC of the PoC Client granted a permission to send a Media Burst field all 32 bits set to '1';
- 4. SHALL include Privacy as specified in the subclause 6.5.2.1 "*MBCP specific fields*", if privacy is requested;
- 5. MAY include notification of the number of Participants connected to the Media-floor Control Entity; and,
- 6. MAY include Anonymous identity as specified in subclause 6.5.2.1 "*MBCP specific fields*", if privacy is requested.

- ii. SHALL perform the actions specified in the subclause 6.4.5.3.1 "*Enter the 'U: not permitted and MB_Taken' state*".
4. If the PoC Client is invited to a PoC Session and
- if another PoC Client has permission to send a Media Burst, the PoC Server:
- a. SHOULD send a MBCP Media Burst Taken message to the PoC Client;
MBCP Media Burst Taken message:
 - i. SHALL include the identity of the PoC User that has been given permission to send a Media Burst as specified in subclause 8.2 "*Sender Identification*";
 - ii. SHALL include the SSRC of the PoC Client granted a permission to send a Media Burst, if known by the PoC Server, or alternatively;
 - iii. SHALL have the SSRC of the PoC Client granted a permission to send a Media Burst field all 32 bits set to '1';
 - iv. SHALL include Privacy as specified in the subclause 6.5.2.1 "*MBCP specific fields*", if privacy requested;
 - v. MAY include notification of the number of Participants connected to the Media-floor Control Entity; and,
 - vi. MAY include Anonymous identity as specified in subclause 6.5.2.1 "*MBCP specific fields*", if privacy is requested.
 - b. SHALL perform the actions specified in the subclause 6.4.5.3.1 "*Enter the 'U: not permitted and MB_Taken'*".
- if no other PoC Client has the permission to send a Media Burst; the PoC Server:
- c. SHOULD send a MBCP Media Burst Idle message to the PoC Client; and,
 - d. SHALL perform the actions specified in the subclause 6.4.5.2.1 "*Enter the 'U: not permitted and MB_Idle' state*".

6.4.5.1.2 Media-floor Control Entity initiated

When the associated PoC Client initiates or connects a Media-floor Control Entity during a PoC Session and

- 1. if the Media-floor Control Entity is initiated by the PoC Client the PoC Server:
 - a. SHALL perform the actions in the subclause 6.4.5.2.1 "*Enter the 'U: not permitted and MB_Idle' state*".

NOTE: The sending of the MBCP Media Burst Idle message is initiated by the general state machine operations as specified in the subclause PoC Server state transition diagram for basic Media Burst operation to the PoC Client.

- 2. If the Media-floor Control Entity is already existing and if no other PoC Client has the permission to send Media the PoC Server:
 - a. SHOULD send a MBCP Media Burst Idle message; and,
 - b. SHALL perform the actions in the subclause 6.4.5.2.1 "*Enter the 'U: not permitted and MB_Idle' state*".
- 3. If the Media-floor Control Entity is already existing and if another PoC Client has the permission to occupy the Media-floor the PoC Server:

- a. SHALL send a MBCP Media Burst Taken message.

The MBCP Media Burst Taken message:

- i. SHALL include the identity of the PoC User that has been given permission to send a Media Burst as specified in subclause 8.2 "*Sender Identification*";
 - ii. SHALL include the SSRC of the PoC Client granted a permission to send a Media Burst, if known by the PoC Server, or alternatively;
 - iii. SHALL have the SSRC of the PoC Client granted a permission to send a Media Burst field all 32 bits set to '1';
 - iv. SHALL include Privacy as specified in the subclause 6.5.2.1 "*MBCP specific fields*", if privacy requested;
 - v. MAY include notification of the number of Participants connected to the Media-floor Control Entity; and,
 - vi. MAY include Anonymous identity as specified in subclause 6.5.2.1 "*MBCP specific fields*", if privacy requested.
- b. SHALL perform the actions in the subclause 6.4.5.3.1 "*State P: not permitted and MB_Taken*".

6.4.5.2 State U: not permitted and MB_Idle

The 'U: not permitted and MB_Idle' state is a stable state and the PoC Server uses this state when the associated PoC Client is not permitted to send a Media Burst.

6.4.5.2.1 Enter the 'U: not permitted and MB_Idle' state

When entering this state the PoC Server:

1. SHALL set the state for the associated PoC Client to 'U: not permitted and MB_Idle'.

6.4.5.2.2 Permission state change

If another PoC Client than the associated PoC Client in the PoC Session is granted the permission to send a Media Burst, the PoC Server

- SHALL perform the actions specified in the subclause 6.4.5.3.1 "*Enter the 'U: not permitted and MB_Taken' state*".

6.4.5.2.3 Receive MBCP Media Burst Request message (R: MB_Request)

Upon receiving a MBCP Media Burst Request the PoC Server:

1. SHALL perform the actions in the subclause 6.4.4.2.2 "*Receive MBCP Media Burst Request message (R: MB_Request)*".
2. If a MBCP Media Burst Granted message is sent the PoC Server:
 - a. SHALL perform actions in 6.4.5.3.1 "*Enter the 'U: not permitted and MB_Taken' state*".
3. Otherwise the PoC Server:
 - a. SHALL remain in the 'U: not permitted and MB_Idle' state.

NOTE: The state change for all other PoC Clients is described in 6.4.5.2.2 "*Permission state change*" if a state change occurs.

6.4.5.2.4 Receive MBCP Media Burst Release message (R: MB_Release)

Upon receiving a MBCP Media Burst Release message from the associated PoC Client the PoC Server:

1. SHALL send a MBCP Media Burst Idle message to the PoC Client; and,
2. SHALL remain in the state 'U: not permitted and MB_Idle' state.

6.4.5.2.5 Receive RTP Media packets (R: Media)

Upon receiving RTP Media packets with payload from the associated PoC Client and if MBCP Media Burst Release message was received in the previous 'U: permitted' state and if the Local Granted Mode is not used the PoC Server:

1. SHALL NOT forward the received RTP Media packets to other PoC Clients in the PoC Session; and,
2. SHALL remain in the state 'U: not permitted and MB_Idle' state.

NOTE 1: It is an implementation issue for the PoC Server how to check whether the MBCP Media Burst Release message was received in the previous state 'U: permitted' or not.

Upon receiving valid RTP Media packets from the associated PoC Client and if MBCP Media Burst Release message was not received in the previous state 'U: permitted' state and if the Local Granted Mode is not used the PoC Server:

1. SHALL NOT forward the received RTP Media packets to other PoC Clients in the PoC Session;
2. SHALL send a MBCP Media Burst Revoke message to the associated PoC Client.

The MBCP Media Burst Revoke message:

- a. SHALL include the reason code field 'No permission to send a Media Burst'.
3. SHALL perform the actions specified in the subclause 6.4.5.7.1 "*Enter the 'U: not permitted but sending RTP Media packets' state*".

NOTE 2: It is an implementation issue for the PoC Server how to check whether the MBCP Media Burst Release message was received in the previous state 'U: permitted' or not.

Upon receiving RTP Media packets with payload from the associated PoC Client and if Local Granted Mode is negotiated as specified in [OMA-PoC-CP] the PoC Server,

1. SHALL perform actions in the subclause 6.4.4.3.1 "*Enter the state 'G: MB_Taken'*" without sending the MBCP Media Burst Granted message;
2. SHALL perform the actions specified in 6.4.5.4.1 "*Enter the state 'U: permitted' state*"; and,
3. SHALL perform actions in the 6.4.5.4.5 "*Receive RTP Media packets (R: Media)*".

6.4.5.2.6 Receive MSRP SEND request (R: MSRP SEND)

Upon receiving a MSRP SEND request from the associated PoC Client and if a MBCP Media Burst Release message was received in the previous 'U: permitted' state the PoC Server:

1. SHALL generate and send an MSRP 413 response according to rules and procedures of [OMA-PoC-IM];
2. SHALL NOT forward the received MSRP SEND to other PoC Clients in the PoC Session.
3. SHALL remain in the state 'U: not permitted and MB_Idle' state.

NOTE: It is an implementation issue for the PoC Server how to check whether the MBCP Media Burst Release message was received in the previous state 'U: permitted' or not.

Upon receiving a MSRP SEND request from the associated PoC Client and if MBCP Media Burst Release message was not received in the previous state 'U: permitted' state

1. SHALL generate and send an MSRP 413 response according to rules and procedures of [OMA-PoC-IM];
2. SHALL NOT forward the received MSRP SEND request to other PoC Clients.
3. SHALL send a MBCP Media Burst Revoke message to the associated PoC Client.

The MBCP Media Burst Revoke message:

- a. SHALL include the reason code field 'No permission to send a Media Burst'.
4. SHALL perform the actions specified in the subclause 6.4.5.7.1 "*Enter the 'P: not permitted but sends Media' state*".

6.4.5.3 State U: not permitted and MB_Taken

The 'U: not permitted and MB_Taken' state is a stable state and the PoC Server uses this state when another PoC Client (not the associated PoC Client) has been given permission to send Media.

6.4.5.3.1 Enter the 'U: not permitted and MB_Taken' state

When entering this state the PoC Server:

1. SHALL set the basic state to 'U: not permitted and MB_Taken'.

6.4.5.3.2 Permission state change

When the general state machine changes its state to 'G: MB_Idle' the PoC Server:

1. SHALL perform the actions specified in the subclause 6.4.5.2.1 "*Enter the 'U: not permitted and MB_Idle' state*".

6.4.5.3.3 Receive MBCP Media Burst Request message (R: MB_Request)

Upon receiving a MBCP Media Burst Request message from the associated PoC Client, if the PoC Client did not negotiate "queuing" and did not negotiate "tb_priority", the PoC Server:

1. SHALL send a MBCP Media Burst Deny message to the associated PoC Client.

The MBCP Media Burst Deny message:

- a. SHALL include the reason code field 'Another PoC User has permission'.
2. SHALL remain in the 'U: not permitted and MB_Taken' state.

Upon receiving a MBCP Media Burst Request message from the associated PoC Client, if the PoC Client negotiated "queuing" or "tb_priority", the PoC Server:

1. SHALL determine the effective priority level as follows
 - a. the lower of the priority level included in MBCP Media Burst Request message and the negotiated maximum priority level that the PoC Client is permitted to request, if the PoC Client negotiated "tb_priority" and priority level is included in the MBCP Media Burst Request message;
 - b. the receive only priority, if the PoC Client negotiated "tb_priority" and if the negotiated maximum priority level that the PoC Client is permitted to request is receive only;
 - c. the normal priority, if the PoC Client negotiated "tb_priority", if the negotiated maximum priority level that the PoC Client is permitted to request is not receive only and if the priority level is not included in the MBCP Media Burst Request message; and,
 - d. the normal priority, if the PoC Client did not negotiate "tb_priority".

2. if the effective priority level is receive only, the PoC Server:
 - a. SHALL send a MBCP Media Burst Deny message to the PoC Client.
The MBCP Media Burst Deny message:
 - i. SHALL include the reason code field 'Receive only'.
 - b. SHALL remain in the 'U: not permitted and MB_Taken' state.or,
3. if the PoC Client is already queued with the same effective priority level, the PoC Server:
 - a. SHALL send a MBCP Media Burst Request Queue Status message to the requesting PoC Client. if the PoC Client negotiated "queuing"
The MBCP Media Burst Request Queue Status message:
 - i. SHOULD indicate the position of the PoC Client in the Media Burst request queue; and,
 - ii. MAY indicate the priority level of the PoC Client in the Media Burst request queue;NOTE: If the PoC Client did not negotiate "queuing", no response is sent to the PoC Client now.
or,
4. if the effective priority level is pre-emptive and there are no other pre-emptive requests in the Media Burst request queue and the effective priority level of the current PoC Client with permission to send a Media Burst is not the pre-emptive priority, the PoC Server:
 - a. SHALL perform the action in the subclause 6.4.4.3.6 "*Receive MBCP Media Burst Request message with pre-emptive priority (R: MB_Request (pre-emptive))*";or,
5. if the PoC Client did not negotiate "queuing", the effective priority level is pre-emptive and either other pre-emptive request is queued or the effective priority level of the current PoC Client with permission to send a Media Burst is the pre-emptive priority, the PoC Server:
 - a. SHALL send a MBCP Media Burst Deny message to the associated PoC Client.
The MBCP Media Burst Deny message:
 - i. SHALL include the reason code field 'Another PoC User has permission'.
 - b. SHALL remain in the 'U: not permitted and MB_Taken' state.or,
6. if the PoC Client did not negotiate "queuing" and the effective priority level is not pre-emptive, the PoC Server:
 - a. SHALL send a MBCP Media Burst Deny message to the associated PoC Client.
The MBCP Media Burst Deny message:
 - i. SHALL include the reason code field 'Another PoC User has permission'.
 - b. SHALL remain in the 'U: not permitted and MB_Taken' state.or,

7. if the PoC Client negotiated "queuing" , the PoC Server :
- a. SHALL either insert the PoC Client into the Media Burst request queue, if not inserted yet, or update the position of the PoC Client in the Media Burst request queue, if already inserted, as follows:
 - i. If the PoC Client negotiated "timestamp" and the timestamp is included in the MBCP Media Burst Request message
 1. to the position immediately following all queued requests at the same effective priority level with an earlier timestamp and immediately in front of all queued requests at the same effective priority level with a later timestamp. The position of the request relative to other requests at the same effective priority level which were not time-stamped SHALL be determined according to the policy of the PoC Server;
 - or,
 - ii. If the timestamp is not included in the MBCP Media Burst Request message or if this option is not supported by the PoC Server
 1. to the position immediately following all queued requests at the same effective priority level.
 - b. The PoC Server SHALL send a MBCP Media Burst Request Queue Status message to the PoC Client.
The MBCP Media Burst Request Queue Status message:
 - i. SHOULD indicate the position of the PoC Client in the Media Burst request queue; and,
 - ii. MAY indicate the priority level of the PoC Client in the Media Burst request queue.
 - c. SHOULD send a MBCP Media Burst Request Queue Status message with the updated status to the PoC Clients in the Media Burst request queue which negotiated "queuing", which have requested the queue status, whose queue position has been changed since the previous MBCP Media Burst Request Queue Status message and which are not the requesting PoC Client.
The MBCP Media Burst Request Queue Status message:
 - i. SHOULD indicate the position of the PoC Client in the Media Burst request queue; and,
 - ii. MAY indicate the priority level of the PoC Client in the Media Burst request queue.
 - d. SHALL remain in the 'U: not permitted and MB_Taken' state.

6.4.5.3.4 Receive MBCP Media Burst Release message (R: MB_Release)

Upon receiving a MBCP Media Burst Release message from the associated PoC Client, if the PoC Client did not negotiate "queuing" and did not negotiate "tb_priority", the PoC Server:

1. SHALL send a MBCP Media Burst Taken message to the associated PoC Client.

The MBCP Media Burst Taken message:

- a. SHALL include the identity of the PoC User that has been given permission to send a Media Burst as specified in subclause 8.2 "*Sender Identification*";
- b. SHALL include the SSRC of the PoC Client granted a permission to send a Media Burst, if known by the PoC Server, or alternatively;
- c. SHALL have the SSRC of the PoC Client granted a permission to send a Media Burst field all 32 bits set to '1'; and,
- d. MAY include notification of the number of Participants connected to the Media-floor Control Entity.

2. SHALL remain in the 'U: not permitted and MB_Taken' state.

Upon receiving a MBCP Media Burst Release from the associated PoC Client, if the PoC Client negotiated "queuing" or "tb_priority", the PoC Server:

1. SHALL remove the PoC Client from the Media Burst request queue, if the PoC Client was in the Media Burst request queue;
2. SHALL send a MBCP Media Burst Taken message to the associated PoC Client.

The MBCP Media Burst Taken message:

- a. SHALL include the identity of the PoC User that has been given permission to send a Media Burst as specified in subclause 8.2 "*Sender Identification*";
 - b. SHALL include the SSRC of the PoC Client granted a permission to send a Media Burst, if known by the PoC Server, or alternatively;
 - c. SHALL have the SSRC of the PoC Client granted a permission to send a Media Burst field all 32 bits set to '1'; and,
 - d. MAY include notification of the number of Participants connected to the Media-floor Control Entity.
3. SHOULD send a MBCP Media Burst Request Queue Status message with the updated status to the PoC Clients in the Media Burst request queue which negotiated "queuing", which have requested the queue status and whose queue position has been changed since the previous MBCP Media Burst Request Queue Status message

The MBCP Media Burst Request Queue Status message:

- a. SHOULD indicate the position of the PoC Client in the Media Burst request queue; and,
 - b. MAY indicate the priority level of the PoC Client in the Media Burst request queue.
4. SHALL remain in the 'U: not permitted and MB_Taken' state.

6.4.5.3.5 Receive RTP Media packets (R: Media)

Upon receiving RTP Media packets with payload from the associated PoC Client, the PoC Server:

1. SHALL NOT forward the RTP Media packets to the other PoC Clients in the PoC Session;
2. SHALL send a MBCP Media Burst Revoke message to the associated PoC Client.

The MBCP Media Burst Revoke message:

- a. SHALL include the reason code field 'No permission to send a Media Burst';
3. SHALL perform the actions specified in the subclause 6.4.5.7.1 "*Enter the 'U: not permitted but sends RTP Media packets' state*".

6.4.5.3.6 Receive MSRP SEND request (R: MSRP SEND)

Upon receiving a MSRP SEND request from the associated PoC Client, the PoC Server:

1. SHALL generate and send an MSRP 413 response according to rules and procedures of [OMA-PoC-IM];
2. SHALL NOT forward the MSRP SEND request to the other PoC Clients in the PoC Session;
3. SHALL send a MBCP Media Burst Revoke message to the associated PoC Client.

The MBCP Media Burst Revoke message:

- a. SHALL include the reason code field 'No permission to send a Media Burst'.

4. SHALL perform the actions specified in the subclause 6.4.5.7.1 "*Enter the 'U: not permitted but sends Media state'*".

6.4.5.4 State U: permitted

The 'U: permitted' state is a stable state and the PoC Server uses this state when the associated PoC Client has been given permission to send a Media Burst.

The timer T1 (End of RTP Media) is running in the general state machine if Continuous Media is bound to the Media-floor Control Entity.

The timer T2 (Stop talking) can be running in the general state machine if only Continuous Media is bound to the Media-floor Control Entity.

The timer T19 (start of MSRP) timer is running in the general state machine if only Discrete Media is bound to the Media-floor Control Entity is bound to the Media-floor Control Entity.

The timer T18 (end of Media-floor time) timer is running in the general state machine if Discrete Media is bound to the Media-floor Control Entity.

The T20 (Granted re-send) timer is running in the general state machine, if the granted PoC Client was queued and if the PoC Client supports "queuing".

The timers T1 (End of RTP Media), T2 (Stop talking), T19 (start of MSRP) timer and T18 (end of Media-floor time) timer are controlled by the general state machine as specified in subclause 6.4.4 "*PoC Server state transition diagram for general Media Burst operation*" but shown described in this state for readability and completeness reasons.

6.4.5.4.1 Enter the state 'U: permitted'

When entering this state the PoC Server:

1. SHALL start the T1 (End of RTP Media) timer;
2. SHALL start the T19 (start of MSRP) in the case only Discrete Media is bound to the Media-floor Control Entity; and,
3. SHALL set the state for the associated PoC Client to 'U: Permitted'.

6.4.5.4.2 Receive MB CP Media Burst Release message (R: MB_Release)

Upon receiving a MB CP Media Burst Release message from the associated PoC Client the PoC Server and in the case Continuous Media is bound to the Media-floor Control Entity, (the message includes an indication of the sequence number of the last RTP Media packet):

1. and, if last RTP Media packet is not received the PoC Server:
 - a. SHALL store last sequence number indicated in the message; and,
 - b. SHALL remain in the state 'U: permitted'.
2. or, if last RTP Media packet is already received the PoC Server:
 - a. SHALL stop the T2 (Stop talking) timer, if the timer is running; and
 - b. SHALL perform the actions specified in the 6.7.4.1.1 "*Enter the 'U: not permitted and MB_Idle' state'*".
3. or, if the sequence number was set to invalid in the MB CP Media Burst Release message, the PoC Server:
 - a. SHALL stop the T2 (Stop talking) timer, if the timer is running; and
 - b. SHALL perform the actions specified in the 6.7.4.1.1 "*Enter the 'U: not permitted and MB_Idle' state'*".

Upon receiving a MBCP Media Burst Release message from the associated PoC Client the PoC Server and in the case only Discrete Media is bound to the Media-floor Control Entity and

1. if the last chunk of an MSRP SEND request is not received, then the PoC Server:
 - a. SHALL remain in the state 'U: permitted'.
2. If there no outstanding chunks of an MSRP SEND request then the PoC Server:
 - a. SHALL stop the T18 (end of Media-floor time), if the timer is running; and,
 - b. SHALL perform the actions specified in the subclause 6.7.4.1.1 "Enter the 'U: not permitted and MB_Idle' state".

NOTE: MBCP Media Burst Request Queue Status message are sent to PoC Clients waiting in the Media Burst request queue in subclause 6.4.4.2.1 "Enter the 'G: MB_Idle state'".

6.4.5.4.3 T1 (End of RTP Media) timer fired

On expiry of T1 (End of RTP Media) timer, the PoC Server:

1. SHALL stop the T2 (Stop talking) timer or T18 (end of Media-floor time), if any of the timers are running; and,
2. SHALL perform the actions specified in the subclause 6.4.5.2.1 "Enter the 'U: not permitted MB_Idle' state".

6.4.5.4.4 T2 (Stop talking) timer fired

On expiry of the T2 (Stop talking) timer, the PoC Server:

1. if MBCP Media Burst Release message was already received in this state:
 - a. SHALL perform the actions specified in the subclause 6.4.5.2.1 "Enter the 'U: not permitted MB_Idle' state".
2. if MBCP Media Burst Release message was not received in this state:
 - a. SHALL send a MBCP Media Burst Revoke message to the associated PoC Client.

The MBCP Media Burst Revoke message:

- i. SHALL include the reason code field 'Media Burst too long'; and,
 - ii. SHOULD include the retry-after time.
3. SHALL perform the actions specified in the subclause 6.4.5.5.1 "Enter the 'U: pending MB_Revoke' state".

6.4.5.4.5 Receive RTP Media packets (R: Media)

Upon receiving RTP Media packets with payload from the associated PoC Client the PoC Server:

1. SHALL perform actions in subclause 6.4.4.3.4 "Receive RTP Media packets (R: Media from permitted client)";
 - a. SHALL start the T2 (Stop talking) timer if not already running if only Continuous Media is bound to the Media-floor Control Entity;
 - b. SHALL start the T18 (end of Media-floor time) timer if Discrete Media is bound to the Media-floor Control Entity; and,
 - c. SHALL maintain the 'U: permitted' state.
2. if the PoC Server detects the last RTP Media packet of the Media Burst, the PoC Server:

- a. SHALL stop the T2 (Stop talking) timer or the T18 (end of Media-floor timer) depending on which timer is running; and,
- b. SHALL perform the actions specified in the subclause 6.4.5.2.1 "*Enter the 'U: not permitted MB_Idle' state*".

6.4.5.4.6 Receive MBCP Media Burst Request message (R: MB_Request)

Upon receiving a MBCP Media Burst Request message from the associated PoC Client the PoC Server:

1. SHALL perform the actions in subclause 6.4.4.3.7 "*Receive MBCP Media Burst Request message from permitted PoC Client (R: MB_Request)*";
2. SHALL store the SSRC of PoC Client requesting a permission to send a Media Burst until the end of the Media Burst associated to that Media Burst Request; and,
3. SHALL remain in the 'U: permitted' state.

6.4.5.4.7 T19 (start of MSRP) timer fired

On expiry of T19 (start of MSRP) timer, the PoC Server:

1. SHALL perform the actions specified in the subclause 6.4.5.2.1 "*Enter the 'U: not permitted MB_Idle' state*".

6.4.5.4.8 T18 (end of Media-floor time) timer fired

On expiry of the T18 (end of Media-floor time) timer, the PoC Server:

1. if MBCP Media Burst Release message was already received in this state:
 - a. SHALL perform the actions specified in the subclause 6.4.5.2.1 "*Enter the 'U: not permitted MB_Idle' state*".
2. if MBCP Media Burst Release message was not received in this state:
 - a. SHALL send a MBCP Media Burst Revoke message to the associated PoC Client.

The MBCP Media Burst Revoke message:

- i. SHALL include the reason code field 'Media Burst too long';
- ii. SHOULD include the retry-after time; and,
- iii. SHALL perform the actions specified in the subclause 6.4.5.5.1 "*Enter the 'U: pending MB_Revoke' state*".

6.4.5.4.9 Receive MSRP SEND request (R: MSRP SEND)

Upon receiving a MSRP SEND request from the associated PoC Client the PoC Server:

1. SHALL perform the actions in subclause 6.4.4.3.12 "*MSRP SEND request received (R: MSRP SEND)*"; and,
 - a. SHALL stop the T19 (start of MSRP) if the timer is running;
 - b. SHALL start the T18 (end of Media-floor time) if not already running; and,
 - c. SHALL maintain the 'U: permitted' state.

6.4.5.5 State 'U: pending MB_Revoke'

The 'U: pending MB_Revoke' state is a transition state and the PoC Server uses this state during the grace period after sending the MBCP Media Burst Revoke message.

In this state:

- The T3 (Stop Talking grace) timer is running.
- The T8 (Media Burst Revoke) timer is running.
- The T1 (End of RTP) timer is running in case Continuous Media is bound to the Media-floor Control Entity.
- The T19 (start of MSRP) is running in this state if only Discrete Media is bound to the Media-floor Control Entity.

The T1 (End of RTP) timer, the T3 (Stop Talking grace) timer and the T19 (start of MSRP) are started and stopped by the general state machine procedure but added in this subclause for readability and completeness reasons.

6.4.5.5.1 Enter the state 'U pending MB_Revoke'

When entering this state the PoC Server:

1. SHALL start the T3 (Stop talking grace) timer;
2. SHALL start the T8 (Media Burst Revoke) timer; and,
3. SHALL set the state for the associated PoC Client to 'U: pending MB_Revoke'.

6.4.5.5.2 T8 (Media Burst Revoke) timer fired

On expiry of the T8 (Media Burst Revoke) timer the PoC Server:

1. SHALL retransmit the MBCP Media Burst Revoke message to the associated PoC Client.

The MBCP Media Burst Revoke message:

- a. SHALL include the reason code field 'Media Burst too long'; and,
 - b. SHOULD include the previous retry after time, which MAY be decremented by T8 (Media Burst Revoke) seconds.
2. SHALL start the T8 (Media Burst Revoke) timer; and,
 3. SHALL remain in the 'U: pending MB_Revoke' state.

6.4.5.5.3 T3 (Stop talking grace) timer fired

On expiry of the T3 (Stop talking grace) timer the PoC Server:

1. SHALL perform the actions specified in the 6.4.5.6.1 "*Enter the 'U: waiting MB_Revoke' state*".

6.4.5.5.4 Receive RTP Media packets (R: Media)

Upon receiving a RTP Media packet with payload from the associated PoC Client different from the last RTP Media packet with payload the PoC Server:

NOTE 1: Prior to the reception of the MBCP Media Burst Release message the PoC Server cannot determine if the received RTP Media packet is the last RTP Media packet and handles all received RTP Media packets as being not the last.

1. SHALL perform actions in subclause 6.4.4.5.2 "*Receive RTP Media packets (R: Media from permitted client)*";
2. SHALL restart T1 (End of RTP Media) timer; and,
3. SHALL remain in the 'U: pending MB_Revoke' state.

NOTE 2: The T1 timer above is started and stopped by the general state machine procedure but added in the list above for readability and completeness reasons.

6.4.5.5.5 Receive MBCP Media Burst Release message (R: MB_Release)

Upon receiving a MBCP Media Burst Release message (the message includes an indication of the sequence number of the last RTP Media packet) and if Continuous Media is bound to the Media-floor Control Entity and

1. if last RTP Media packet is not received the PoC Server:
 - a. SHALL store last sequence number indicated in the message; and,
 - b. SHALL remain in the state 'U: pending MB_Revoke'.
2. If last RTP Media packet is already received the PoC Server:
 - a. SHALL stop the timer T3 (Stop talking grace) timer;,,
 - b. according to the PoC Server local policy either
 - i. SHALL send the MBCP Media Burst Idle message to the associated PoC Client; and,
 - ii. SHALL perform the actions specified in the 6.7.4.1.1 "*Enter the 'U: not permitted and MB_Idle' state*".

NOTE 1: To allow a PoC Client, who had exceeded the maximum allowed time to send Media and from whom the PoC Server received MB_Release message before T3 (Stop talking grace) timer expired, to request the Media Burst permission without the penalty period, the steps i. and ii. are highly recommended.

or,

- iii. SHALL perform the actions specified in the 6.4.5.6.1 "*Enter the 'U: waiting MB_Revoke' state*".

3. If the sequence number was set to invalid in the MBCP Media Burst Release message, the PoC Server:
 - a. SHALL stop the T3 (Stop talking grace) timer; and,
 - b. according to the PoC Server local policy either
 - i. SHALL send the MBCP Media Burst Idle message to the associated PoC Client; and,
 - ii. SHALL perform the actions specified in the 6.7.4.1.1 "*Enter the 'U: not permitted and MB_Idle' state*".

NOTE 2: To allow a PoC Client, who had exceeded the maximum allowed time to send Media and from whom the PoC Server received MB_Release message before T3 (Stop talking grace) timer expired, to request the Media Burst permission without the penalty period, the steps i. and ii. are highly recommended.

or,

- iii. SHALL perform the actions specified in the 6.4.5.6.1 "*Enter the 'U: waiting MB_Revoke' state*".

Upon receiving a MBCP Media Burst Release message and if only Discrete Media is bound to the Media-floor Control Entity and

1. if last chunk of the last received MSRP SEND request is not received the PoC Server:
 - a. SHALL remain in the state 'P: pending MB_Revoke'.
2. If there are no remaining chunks of the last received MSRP SEND request the PoC Server:
 - a. SHALL stop the timer T3 (Stop talking grace) timer; and.
 - b. according to the PoC Server local policy the PoC Server either

- i. SHALL send the MBCP Media Burst Idle message to the associated PoC Client; and,
- ii. SHALL perform the actions specified in the 6.4.5.2.1 "*Enter the 'P: not permitted and MB_Idle' state*".

NOTE 3: To allow a PoC Client, who had exceeded the maximum allowed time to send Media and from whom the PoC Server received MB_Release message before T3 (Stop talking grace) timer expired, to request the Media Burst permission without the penalty period, the steps i. and ii. above are highly recommended.

or,

- iii. SHALL perform the actions specified in the 6.4.5.6.1 "*Enter the 'P: waiting MB_Revoke' state*".

6.4.5.5.6 Receive last RTP Media packet (R: Last Media)

Upon receiving a RTP Media packet with payload with the same sequence number as indicated by the MBCP Media Burst Release message to be the last RTP Media packet the PoC Server:

1. SHALL perform actions in subclause 6.4.4.5.4 "*Receive last RTP Media packets (R: Last Media)*";
2. SHALL stop the timer T3 (Stop talking grace) timer; and,
3. according to the PoC Server local policy either
 - a. SHALL send the MBCP Media Burst Idle message to the associated PoC Client; and,
 - b. SHALL perform the actions specified in the 6.7.4.1.1 "*Enter the 'U: not permitted and MB_Idle' state*".

or,

- c. SHALL perform the actions specified in the 6.4.5.6.1 "*Enter the 'U: waiting MB_Revoke' state*".

NOTE: To allow a PoC Client, who had exceeded the maximum allowed time to send Media and from whom the PoC Server received MB_Release message before T3 (Stop talking grace) timer expired, to request the Media Burst permission without the penalty period, the steps a. and b. are highly recommended.

6.4.5.5.7 T1 (End of RTP Media) timer fired

On expiry of the T1 (End of RTP Media) timer the PoC Server:

1. SHALL stop the timer T3 (Stop talking grace) timer; and,
2. according to the PoC Server local policy either
 - a. SHALL send the MBCP Media Burst Idle message to the associated PoC Client; and,
 - b. SHALL perform the actions specified in the 6.7.4.1.1 "*Enter the 'U: not permitted and MB_Idle' state*".

NOTE: To allow a PoC Client, who had exceeded the maximum allowed time to send Media and from whom the PoC Server received MB_Release message before T3 (Stop talking grace) timer expired, to request the Media Burst permission without the penalty period, the steps a. and b. are highly recommended.

or,

- c. SHALL perform the actions specified in the 6.4.5.6.1 "*Enter the 'U: waiting MB_Revoke' state*".

6.4.5.5.8 The timer T19 (start of MSRP) fired

On expiry of the timer T19 (start of MSRP) timer the PoC Server:

1. SHALL perform the actions specified in the 6.4.5.6.1 "*Enter the 'U: waiting MB_Revoke' state*".

6.4.5.5.9 Receive a MSRP SEND request (R: MSRP SEND)

Upon receiving a MSRP SEND request from the associated PoC Client the PoC Server:

1. SHALL perform the actions in subclause 6.4.4.5.7 "*MSRP SEND request received (R: MSRP SEND)*"; and,
2. SHALL stop the T19 (start of MSRP) timer; and,

6.4.5.5.10 Receive last chunk in an MSRP SEND request (R: Last MSRP SEND)

Upon receiving a the last chunk in a MSRP SEND request the PoC Server:

1. SHALL perform the actions in subclause 6.4.4.5.7 "*MSRP SEND request received (R: MSRP SEND)*"; and,
2. if only Discrete Media is bound to the Media-floor Control the PoC Server:
 - a. SHALL stop the timer T3 (Stop talking grace) timer; and,
 - b. according to the PoC Server local policy the PoC Server either
 - i. SHALL send the MBCP Media Burst Idle message to the associated PoC Client; and,
 - ii. SHALL perform the actions specified in the 6.4.5.2.1 "*Enter the 'U: not permitted and MB_Idle' state*".

NOTE: To allow a PoC Client, who had exceeded the maximum time to occupy the Media-floor and from whom the PoC Server received MB_Release message before T3 (Stop talking grace) timer expired, to request the Media Burst permission without the penalty period, the steps i. and ii. above are highly recommended.

or,

- iii. SHALL perform the actions specified in the 6.4.5.6.1 "*Enter the 'P: waiting MB_Revoke' state*".

6.4.5.6 State 'U: waiting MB_Revoke'

The 'U: waiting MB_Revoke' state is a stable state and during the time the PoC Client is not allowed to request for the permission to send a Media Burst as a penalty for misusing its permission to send a Media Burst.

Timer T9 (retry-after) is running in this state.

NOTE: This state is required in order to not destroy a PoC Session in the case a PoC Client is misbehaving and requests for permission to send a Media Burst all the time.

6.4.5.6.1 Enter the 'U: waiting MB_Revoke' state

When entering this state the PoC Server:

1. SHALL start the T9 (Retry-after) timer; and,
2. SHALL set the state for the associated PoC Client to 'U: waiting MB_Revoke'.

During the time the PoC Server is in this state, the PoC Server:

1. SHALL NOT send the MBCP Media Burst Idle message to the associated PoC Client;
2. SHALL send MBCP Media Burst Taken message to the associated PoC Client if another PoC Client is granted the permission to send a Media Burst;
3. SHALL forward RTP Media packets from another PoC Client to the associated PoC Client; and,

4. SHALL forward MSRP SEND requests from another PoC Client to the associated PoC Client.

6.4.5.6.2 Receive Media Burst Request message (R: MB_Request)

Upon receiving a MBCP Media Burst Request message from the associated PoC Client the PoC Server:

1. SHALL send a MBCP Media Burst Deny message to the PoC Client.

The MBCP Media Burst Deny message:

- a. SHALL include the reason code field 'Retry-after timer has not expired'.
2. SHALL remain in the 'U: waiting MB_Revoke' state.

6.4.5.6.3 T9 (Retry-after) timer fired

On expiry of the T9 (Retry-after) timer either,

1. if the general state is 'G: MB_Idle', the PoC Server:
 - a. SHALL send the MBCP Media Burst Idle message; and,
 - b. SHALL perform the actions specified in the subclause 6.4.5.2.1 "*Enter the 'U: not permitted and MB_Idle' state*".

or,

2. if the general state is 'G: MB_Taken', the PoC Server:
 - a. SHALL perform the actions specified in the subclause 6.4.5.3.1 "*Enter the 'U: not permitted and MB_Taken' state*".

6.4.5.7 State U: not permitted but sends Media

The 'U: not permitted but sends Media' state is a transition state and the PoC Server uses this state when it receives RTP Media packets or MSRP SEND requests from the associated PoC Client and the associated PoC Client is not permitted to send a Media Burst.

Timer T8 (Media Burst Revoke) is running in this state.

6.4.5.7.1 Enter the 'U: not permitted but sends Media' state

When entering this state the PoC Server:

1. SHALL start the T8 (Media Burst Revoke) timer; and,
2. SHALL set the state for the associated PoC Client to 'U: not permitted but sends Media'.

When the PoC Server is in this state, the PoC Server:

1. SHALL NOT forward the RTP Media packet to the other PoC Clients in the PoC Session; and,
2. SHALL NOT forward MSRP SEND requests to other PoC Clients in the PoC Session.

6.4.5.7.2 T8 (Media Burst Revoke) timer fired

On expiry of T8 (Media Burst Revoke) timer, the PoC Server:

1. SHALL send a MBCP Media Burst Revoke message to the associated PoC Client.

The MBCP Media Burst Revoke message:

- a. SHALL include the reason code field 'No permission to send a Media Burst'.

- b. SHALL restart T8 (Media Burst Revoke) timer; and,
- c. SHALL remain in the 'U: not permitted but sends Media' state.

NOTE: The number of times the PoC Server retransmits the MBCP Media Burst Revoke message and the action to take when the PoC Server gives up is an implementation issue. However, it is recommended that the PoC Client is disconnected from the PoC Session.

6.4.5.7.3 Receive MBCP Media Burst Release message (R: MB_Release)

Upon receiving a MBCP Media Burst Release message from the associated PoC Client the PoC Server either:

1. if the general state is 'G: MB_Idle', the PoC Server:
 - a. SHALL send the MBCP Media Burst Idle message; and,
 - b. SHALL perform the actions specified in the subclause 6.4.5.2.1 "*Enter the 'U: not permitted and MB_Idle' state*".

or,

2. if the general state is 'G: MB_Taken', the PoC Server:
 - a. SHALL send a MBCP Media Burst Taken message;

MBCP Media Burst Taken message:

 - i. SHALL include the identity of the PoC User that has been given permission to send a Media Burst as specified in subclause 8.2 "*Sender Identification*";
 - ii. SHALL include the SSRC of the PoC Client granted a permission to send a Media Burst, if known by the PoC Server, or alternatively;
 - iii. SHALL have the SSRC of the PoC Client granted a permission to send a Media Burst field all 32 bits set to '1'; and,
 - iv. MAY include notification of the number of Participants connected to the Media-floor Control Entity.
 - b. SHALL perform the actions specified in the subclauses 6.4.5.3.1 "*Enter the 'U: not permitted and MB_Taken' state*".

6.4.5.8 State: Any state

This subclause describes the actions to be taken in all states defined for the basic state diagram with the exception of the 'Start-stop' and 'Releasing' states.

6.4.5.8.1 Receive PoC Session release – 1

Upon receiving a PoC Session release stage 1 request from the Control Plane when the PoC Session is going to be released or when the PoC Client is leaving the PoC Session or when the PoC Client disconnects from the Media-floor Control Entity or when the Media-floor Control Entity is removed from the PoC Session, the PoC Server:

1. SHALL stop sending MBCP messages, MSRP messages and RTP Media packets towards to the PoC Client;
2. SHALL ignore any MBCP messages received from the PoC Client;
3. SHALL stop forwarding RTP Media packets or MSRP messages received from the PoC Client;
4. SHALL perform the actions specified in 6.4.4.2.1 "*Enter state 'G: MB_Idle'*", if the releasing PoC Client has permission to send Media; and,

5. SHALL enter the 'Releasing' state.

6.4.5.9 State: 'Releasing'

The 'Releasing' state is a transition state. The PoC Server uses this state while waiting for the Control Plane to finalize the release of the PoC Session or finalizing the removal of the PoC Client from the PoC Session or finalizing the disconnection of the PoC Client from the Media-floor Control Entity or finalizing the removal of the Media-floor Control Entity from the PoC Session.

6.4.5.9.1 Receive PoC Session release - 2

Upon receiving a PoC Session release stage 2 request from the Control Plane, the PoC Server:

1. SHALL release all User Plane resources and any running timers associated with this Media-floor Control Entity associated with this PoC Client for this PoC Session; and,
2. SHALL enter the 'Start-stop' state and terminate the state machine 'PoC Server state transition for basic normal Media Burst operation to the PoC Client'.

6.4.6 Controlling PoC Function procedures for Media Stream not bound to Media-floor Control Entity

NOTE: The Discrete Media can also be received and distributed as specified in [OMA-PoC-CP] "*Discrete Media request*".

6.4.6.1 Receiving a MSRP SEND request

Upon receiving an MSRP SEND request in the Media Stream not bound to a Media-floor Control Entity, the PoC Server:

1. SHALL generate and send a MSRP 200 "OK" response according to rules and procedures of [OMA-PoC-IM];
2. SHALL generate an MSRP SEND request according to rules and procedures of [OMA-PoC-IM];
3. SHALL send the MSRP SEND request towards:
 - a. all other PoC Clients that are not on hold and whose maximum allowed message size is greater or equal to the size of the content in the received MSRP SEND request, if the PoC Session is neither a 1-many-1 PoC Group Session nor a Dispatch PoC Session;or,
 - b. all Ordinary Participants or PoC Fleet Members that are not on hold and whose maximum allowed message size is greater or equal to the size of the content in the received MSRP SEND request, if the PoC Session is a 1-many-1 PoC Group Session or a Dispatch PoC Session, respectively, and the MSRP SEND request is received from the Distinguished Participant or from the Active PoC Dispatcher sending Media;or,
 - c. the Distinguished Participant or the Active PoC Dispatcher and whose maximum allowed message size is greater or equal to the size of the content in the received MSRP SEND request, if the PoC Session is a 1-many-1 PoC Group Session or a Dispatch PoC Session, respectively, the MSRP SEND request is received from an Ordinary Participant or from a PoC Fleet Member sending Media, and the Distinguished Participant or the Active PoC Dispatcher is not on hold.

NOTE 1: Notice that both 1-many-1 PoC Group Sessions and Dispatch PoC Sessions use the 1-many-1 communication method, so for User Plane sending and receiving Media procedures, the Active PoC Dispatcher is equivalent to the Distinguished Participant and the PoC Fleet Members are equivalent to the Ordinary Participants.

NOTE 2: The sending of reports related to Discrete Media is described in subclauses 7.12 "Discrete Media Transfer Final Report" and 7.13 "Discrete Media Transfer Progress Report".

6.5 Media Burst Control Protocol (MBCP) messages

The Media Burst Control Protocol (MBCP) is based on the RTCP Application Packets (RTCP: APP), as defined in [RFC3550], but MBCP messages do not conform to the rules for compound RTCP packets or RTCP packet transmission. Each MBCP message SHALL be one RTCP: APP packet. These RTCP: APP packets SHALL not be sent in compound RTCP packets, but more than one MBCP Media Burst Control message MAY be sent in a single IP packet. The structure of each MBCP message is defined below.

6.5.1 RTCP: APP message format

6.5.1.1 General

The definition of the fields in the RTCP APP packet is found in [RFC3550].

Table 1 "RTCP: APP message format" shows the RTCP APP packet format.

Table 1: RTCP: APP message format

0				1				2				3											
0	1	2	3	4	5	6	7	8	9	0	1	2	3	4	5	6	7	8	9	0	1	2	3
V=2 P				subtype				PT=APP=204				length											
				SSRC																			
				name (ASCII)																			
				application-dependent data																			

P

The padding bit P SHALL be set to 0.

Length

The length field in the RTCP header is the length of the packet in 32-bit words, not counting the first 32-bit word in which the length field resides.

NOTE 1: The length field can indicate message size longer than specified in this version of the protocol. This can be the case e.g. if message is of later version of this protocol.

Name

The 4-byte ASCII string in the RTCP header SHALL be used to define the set of MBCP Media Burst Control messages to be unique with respect to other APP packets that the application might receive.

For PoC the ASCII name string SHALL be: PoC1.

NOTE 2: The ASCII name field value i.e. PoC1 does not correspond to the PoC Enabler version.

Application-dependent data

The use of application dependent data is specified in the subclause where the MBCP message is specified. If the length of the application dependent data is not a multiple of 4 bytes, the application dependent data SHALL be padded to a multiple of 4 bytes. The value of the padding bytes SHOULD be set to zero. The PoC Client SHALL ignore the value of the padding bytes.

6.5.1.1.1 Handling of unknown fields and messages

When a message is received the PoC Client and the PoC Server SHALL:

- ignore the whole message, if the subtype is unknown;
- ignore the unspecified fields in the message (e.g. specified in future version of the PoC Enabler Release) and,
- ignore the syntactically incorrect optional fields.

6.5.1.2 MBCP specific fields

This subclause list fields specific for MBCP.

The MBCP messages can include the MBCP specific fields. If included, the MBCP specific fields are contained in the application-dependent data of the MBCP message.

Each MBCP specific field consists of an 8-bit Field ID, an 8-bit octet count describing the length of the field value not including this two-octet header, and the field value.

Table 2 "*MBCP specific fields*" lists the available fields including the assigned Field ID.

Table 2: MBCP specific fields

Field name	Field ID	Reference	Description
-	000-099	[RFC3550]	Used by RTCP [RFC3550]
P-count	100	6.5.1.2.1	Participants
T2-timer	101	6.5.1.2.2	Stop talking time
MB-priority-level	102	6.5.1.2.3	MB-priority value
Time-stamp	103	6.5.1.2.4	Time stamp value
Alert-margin	104	6.5.1.2.5	Advanced Revocation Alert time information
Privacy	105	6.5.1.2.6	Privacy for Sender Identification
Anonymous identity	106	6.5.1.2.7	Unique anonymous identity
MBCP-restrict	107	6.5.1.2.8	MBCP usage restrictions
Media-Streams	108	6.5.1.2.9	Media Streams usage
Reason-Header	109	6.5.1.2.10	Reason header value of SIP BYE request
-	110-255	Future releases of the PoC Enabler	Reserved for future use

6.5.1.2.1 P-count

The P-count field SHALL include the value 100 (decimal) indicating that this additional information field is used to indicate the number of Participants in the PoC Session in case the PoC Speech is the only Media in the PoC Session, otherwise the number of Participants connected to the Media-floor Control Entity.

The P-count-length field SHALL include the value 2 indicating the length of this item.

The Participant field SHALL be a 16 bits integer and it SHALL be used as follows:

- 0 = The number of Participant is not known.
- 1 ... 65534 = The number of Participants connected to the Media-floor Control Entity in the PoC Session including the sender.
- 65535 = 65535 or more Participants connected to the Media-floor Control Entity in the PoC Session including the sender.

6.5.1.2.2 T2-timer

The T2-timer field SHALL include the value 101 (decimal) indicating that this additional information field is used to indicate the T2 (Stop talking) timer value.

The T2-length field SHALL include the value 2 indicating the length of this item.

The value of the T2 (Stop talking) timer value SHALL be a 16 bits integer and it SHALL be used as follows:

- 0 = The value of timer T2 is unknown.
- 1 ... 65534 = The value of timer T2 in seconds.
- 65535 = The value of T2 is infinity.

The Stop talking timer value in the MBCP Media Burst Granted message corresponds to the value of timer T2 at the time the timer is started, and therefore the value does not change during the Media Burst.

6.5.1.2.3 MB-priority-level

The MB-priority-level field SHALL have the value 102 (decimal).

The MB-priority-length field SHALL have the value 2 indicating the length of this item.

The MB-priority value field SHALL consist of 16 bit parameter giving a defined Media Burst request priority level.

The defined Media Burst request priority levels that can be included in a MBCP Media Burst Request message are:

- 1 = normal priority.
- 2 = high priority.
- 3 = pre-emptive priority.

All other values are reserved and SHALL NOT be used.

6.5.1.2.4 Time-stamp

The Time-stamp field SHALL have the value 103 (decimal).

The Time-stamp-length field SHALL have the value 8 (decimal) indicating the length of this item.

The Time-stamp-value field SHALL consist of 8 bytes giving an NTP timestamp as specified in RFC [1305].

6.5.1.2.5 Alert Margin

The Alert Margin field SHALL have the value 104 (decimal) indicating that this information field is used to indicate the Alert Margin value.

The Alert Margin length field SHALL include the value 2 indicating the length of this item.

The value of the Alert Margin value SHALL be a 16 bits integer and it SHALL be used as follows:

- 0 = The value of initiation of Remaining time notification.
- 1 ... 65534 = The value of Alert Margin in seconds.
- 65535 = The value of Alert Margin is unknown.

The Alert Margin value SHALL be less than T2-timer value.

6.5.1.2.6 Privacy

If used, the Privacy field SHALL include the value 105 (decimal) indicating that this information field is used to indicate if privacy is requested for Sender Identification.

The Privacy-length field SHALL include the value 2 indicating the length of this item.

The Privacy request field SHALL be a 16 bits integer and it SHALL be used as follows:

- 0 = Privacy not requested.
- 1 = Privacy requested.
- 2 ... 65535 = Not used.

If this optional field is not included then the privacy is not requested.

6.5.1.2.7 Anonymous identity

If used, the Anonymous identity field SHALL include the value 106 (decimal) indicating that this information field is used to indicate a unique identity for an anonymous PoC User.

The Identity-length field SHALL include the value indicating the length of this item.

The Unique anonymous identity field SHALL indicate the PoC Server performing Controlling PoC Function selected unique identity for an anonymous Participant (e.g. anonymous-3@anonymous.invalid).

If the unique anonymous identity functionality is not used, this optional field is not included.

6.5.1.2.8 MBCP-restrict

The MBCP-restrict field SHALL include the value 107 (decimal) indicating that this additional information field is used to indicate the usage of the Media-floor Control Protocol extensions for the Media-floor Control Entity of the PoC Session associated with the Pre-established Session.

The MBCP-restrict-length field SHALL include the value 2 indicating the length of this item.

The MBCP-restrict-value field SHALL be a 16 bits integer and it SHALL be used as follows:

- 0 = Media-floor Control Entity of the PoC Session associated with the Pre-established Session uses all the Media-floor Control Protocol multimedia extensions as specified in [OMA-PoC-CP] "*Media Burst Control Protocol MIME registration*".
- 1 = Media-floor Control Entity of the PoC Session associated with the Pre-established Session does not use the Media-floor Control Protocol multimedia extensions as specified in [OMA-PoC-CP] "*Media Burst Control Protocol MIME registration*".
- 2 ... 65535 = reserved and not used.

6.5.1.2.9 Media-Streams

The Media-Streams field SHALL include the value 108 (decimal) indicating that this additional information field is used to indicate the usage of the Media Streams of the Pre-established Session in the associated PoC Session.

The Media-Streams-length field SHALL indicate the length of this item and is equal to number of SDP "m=" lines of the last SDP offer of the Pre-established Session.

The Media-Streams-value field SHALL indicate whether the Media Streams and the Media-floor Control Entities of the Pre-established Session are used in the associated PoC Session. If the Media Stream or the Media-floor Control Entity, which was negotiated in the N:th SDP "m=" line of the last SDP offer of the Pre-established Session, is used in the PoC Session associated with the Pre-established Session, the N:th octet of the Media-Streams-value SHALL be set to 1, otherwise SHALL be set to 0.

6.5.1.2.10 Reason-Header

The Reason-Header field SHALL include the value 109 (decimal) indicating that this particular item indicates the Reason header [RFC4411] contained in a SIP BYE request that caused the Disconnect message.

The Reason-Header-length field SHALL indicate the length in bytes of the Reason-Header-Value field.

The Reason-Header-Value field SHALL contain the actual value of the Reason header.

The following is an example of a Reason header in a SIP BYE request and its use in the Reason-Header-Value:

```
Preemption ;cause=1 ;text="UA preemption"
```

In this case, the above Reason header value is copied into the Reason-Header-Value field.

NOTE: The text "UA preemption" can be a changed by a different string, matching the corresponding meaning in a different language.

If this optional field is not included then a Reason header was not included in a SIP BYE request that caused the Disconnect message.

6.5.2 MBCP Media Burst Request message

The MBCP Media Burst Request message is a request from a PoC Client to get permission to send a Media Burst.

Table 3 "*MBCP Media Burst Request message*" shows the content of the message.

Table 3: MBCP Media Burst Request message

0										1										2										3									
0	1	2	3	4	5	6	7	8	9	0	1	2	3	4	5	6	7	8	9	0	1	2	3	4	5	6	7	8	9	0	1	2	3	4	5	6	7	8	9
V=2 P 0 0 0 0 0										PT=APP=204										length																			
SSRC of PoC Client requesting permission to send a Media Burst																																							
name=PoC1																																							
MB-priority										MB-priority										MB-priority value																			
-level = 102										-length = 2																													
Time-stamp										Time-stamp																													
= 103										-length = 8																				:									
										Time stamp value																													

The following bit pattern in the subtype field SHALL be used for the MBCP Media Burst Request message: 00000.

SSRC

The SSRC field SHALL carry the SSRC of the PoC Client that is requesting permission to send a Media Burst.

Media Burst request priority

The Media Burst request priority level MAY be included if the PoC Client and the PoC Server have agreed to support queuing of Media Burst requests.

The PoC Client SHALL include the MB-priority-level field if the PoC User has indicated that the Media Burst request is desired at a level other than normal priority, or if the PoC Client wishes to change the MB-priority-level of a queued Media Burst request.

The coding of the Media Burst request priority is specified in subclause 6.5.1.2.3 "*MB-priority-level*".

Time stamp

The Media Burst request timestamp option SHALL be included if the PoC Client and the PoC Server performing the Controlling PoC Function have agreed to support time stamping of MBCP Media Burst request messages as specified in [OMA-PoC-CP] "*Media Burst Control Protocol MIME registration*" and if the PoC Client wishes to timestamp a particular MBCP Media Burst Request message.

The Media Burst request timestamp option SHALL indicate when the original MBCP Media Burst Request message was sent, if the PoC Client repeats the MBCP Media Burst Request message.

If a timestamp is included in a MBCP Media Burst Request message and the request is queued, the PoC Server SHALL use the value of the timestamp to determine the position of the request in the Media Burst request queue.

The request SHOULD be queued according to the timestamp value, after all other requests associated with an earlier timestamp at the same level of priority and before all other requests associated with a later timestamp at the same level of priority.

The position of the request relative to other requests at the same priority, which were not time stamped, and relative to requests at different priority levels, SHALL be determined according to the policy of the PoC Server.

The timestamp option requires time synchronization between the PoC Clients in the PoC Session. However, the PoC network does not define any entity that performs time synchronization between the PoC Clients. Therefore, if a PoC Client supports the timestamp option, it SHALL be provided the NTP timestamp by a timeserver located outside the PoC network (for definition of a timeserver, see [RFC1305]).

NOTE: The timeserver can be the GPS time provided by the protocols of the underlying access network.

The coding of the Media Burst request timestamp is specified in subclause 6.5.1.2.4 "Time-stamp".

6.5.3 MBCP Media Burst Granted message

The MBCP Media Burst Granted message is an action from the PoC Server performing the Controlling PoC Function to inform the requesting PoC Client that it has been granted the permission to send a Media Burst.

Table 4 "MBCP Media Burst Granted message" shows the content of the message.

Table 4: MBCP Media Burst Granted message

0	1	2	3
0 1 2 3 4 5 6 7 8 9 0 1 2 3 4 5 6 7 8 9 0 1 2 3 4 5 6 7 8 9 0 1			
+++++			
V=2 P 0 0 0 0 1	PT=APP=204		length=
+++++			
SSRC of PoC Server performing the Controlling PoC Function			
+++++			
name=PoC1			
+++++			
T2-timer = 101 T2-length = 2		Stop talking time value	
+++++			
P-count = 100 P-count-			
		length = 2 Participants	
+++++			
Alert-		Alert-Margin-	
Margin = 104		length = 2 Alert-margin value	
+++++			

The following bit pattern in the subtype field SHALL be used for the MBCP Media Burst Granted message: 00001.

SSRC

The SSRC field SHALL carry the SSRC of the PoC Server performing the Controlling PoC Function.

Stop talking time

The Stop talking time item SHALL give the time of the T2 (Stop talking) timer.

The Stop talking timer value in the MBCP Media Burst Granted message corresponds to the value of timer T2 at the time the timer is started, and therefore the value does not change during the Media Burst.

The coding of the Stop talking time is specified in subclause 6.5.1.2.2 "T2-timer".

Participants

In case the optional Participants item is included, it SHALL give the number of the Participants currently in the PoC Session in case the PoC Speech is the only Media in the PoC Session, otherwise the number of the Participants connected to the Media-floor Control Entity currently in the PoC Session. The coding of the Participants is specified in subclause 6.5.1.2.1 "P-count".

Alert-Margin

If the optional Alert Margin item is included, it SHALL give the Alert Margin value. The Alert Margin value in the MBCP Media Burst Granted message is defined based on Service Provider Policy.

The coding of the Alert-Margin is specified in subclause 6.5.1.2.5 "Alert Margin".

6.5.4 MBCP Media Burst Deny message

The MBCP Media Burst Deny message is sent as an action from the PoC Server performing the Controlling PoC Function to the requesting PoC Client to inform it that permission to send a Media Burst was rejected.

Table 5 "MBCP Media Burst Deny message" shows the content of the message.

Table 5: MBCP Media Burst Deny message

0										1										2										3									
0	1	2	3	4	5	6	7	8	9	0	1	2	3	4	5	6	7	8	9	0	1	2	3	4	5	6	7	8	9	0	1	2	3	4	5	6	7	8	9
V=2 P 0 0 0 1 1										PT=APP=204										length																			
SSRC of PoC Server performing the Controlling PoC Function																																							
										name=PoC1																													
reason code										length										reason phrase																			
																														:									
																														:									

The following bit pattern in the subtype field SHALL be used for the MBCP Media Burst Deny message: 00011.

Application-dependent data for the MBCP Media Burst Deny message includes a reason in the reason code field and possibly followed by a text-string in the reason phrase field describing why the request was rejected. Therefore the length of the packet will vary depending on the size of the application dependent field.

SSRC

The SSRC field SHALL carry the SSRC of the PoC Server performing the Controlling PoC Function.

Reason code and reason phrase

The first 8 bits in the application-dependent data field is used for the reason code field.

The length field gives the length of the reason phrase field in bytes. If the length field is set to 0, there is no reason in the reason phrase field. The reason phrase field can contain a text string with additional information. The text string SHALL use the same encoding as the text strings in the SDES item CNAME as specified in [RFC3550].

The coding of reason code is specified in subclause 6.5.4.1 "*Reason codes*".

6.5.4.1 Reason codes

6.5.4.1.1 Another PoC User has permission

Indicates that another PoC User has permission to send a Media Burst.

The value of the reason code field SHALL be: 1.

6.5.4.1.2 Internal PoC Server Function error

Indicates that the PoC Server performing the Controlling PoC Function cannot grant the Media Burst request due to an internal error.

The value of the reason code field SHALL be: 2.

6.5.4.1.3 Only one Participant

Indicates that the PoC Server performing the Controlling PoC Function cannot grant the Media Burst request, because the requesting party is the only Participant in the PoC Session or the only Participant connected to a Media-floor Control Entity.

The value of the reason code field SHALL be: 3.

6.5.4.1.4 Retry-after timer has not expired

Indicates that the PoC Server performing the Controlling PoC Function cannot grant the Media Burst request, because timer T9 (Retry-after) has not expired after permission to send a Media Burst has been revoked.

The value of the reason code field SHALL be: 4.

6.5.4.1.5 Receive only

Indicates that the PoC Server performing the Controlling PoC Function cannot grant the Media Burst request, because the requesting party only has receive only privilege.

The value of the reason code field SHALL be: 5.

6.5.4.1.6 No resources available

Indicates that the PoC Server performing the Controlling PoC Function cannot grant the Media Burst request due to congestion.

The value of the reason code field SHALL be: 6.

6.5.4.1.7 Other reason

Indicates that the PoC Server performing the Controlling PoC Function does not grant the Media Burst request due to the PoC Server local policy.

The value of the Reason code field SHALL be: 255.

6.5.5 MBCP Media Burst Release message

The MBCP Media Burst Release message is sent as an action from the PoC Client that has permission to send a Media Burst to the PoC Server performing the Controlling PoC Function to inform it that the Media Burst is completed.

The Media Burst Release message MAY also be sent if the PoC Client and the PoC Server performing the Controlling PoC Function have agreed to support queuing of Media Burst requests and if the PoC Client has a request in the Media Burst request queue. In this case, the MBCP Media Burst Release message is sent as an action from the PoC Client that has requested permission to send a Media Burst to the PoC Server performing the Controlling PoC Function to inform it that the request for a Media Burst is cancelled. The message is used to cancel the request regardless of whether the request has been granted.

Table 6 "MBCP Media Burst Release message" shows the content of the message.

Table 6: MBCP Media Burst Release message

0										1										2										3										
0	1	2	3	4	5	6	7	8	9	0	1	2	3	4	5	6	7	8	9	0	1	2	3	4	5	6	7	8	9	0	1	2	3	4	5	6	7	8	9	
V=2 P 0 0 1 0 0										PT=APP=204										length=3																				
SSRC of PoC Client with permission to send a Media Burst																																								
																				name=PoC1																				
sequence number of last packet I																				padding																				

The following bit pattern in the subtype field SHALL be used for the MBCP Media Burst Release message: 00100.

SSRC

The SSRC field SHALL carry the SSRC of the PoC User with permission to send a Media Burst.

Sequence number of last packet

The application-dependent data field consists of 4 octets.

- The first 16 (0 to 15) bits is the sequence number of the last RTP-packet in the Media Burst.
- Bit 16 is the Ignore Sequence Number field.
- The last 15 (17-31) bits in the application-dependent data field is padding and SHOULD be set to zero. The PoC Server SHALL ignore the value of the padding bytes.

If the PoC Client does not populate the sequence number of the last packet field with a correct sequence number, the PoC Client SHALL set the Ignore Sequence Number field to 1. If Ignore Sequence Number field is set to 1, the PoC Server performing the Controlling PoC Function SHALL ignore the sequence number of the last packet field since the PoC Client has not populated the sequence number of the last packet field with a correct value.

NOTE: The Ignore Sequence Number field is used in case where PoC Client that has a permission to send a Media Burst, releases the Media Burst and in case PoC Clients that utilize radio bearers that prohibit the possibility to keep track of the RTP sequence number of the speech packets, e.g. SO60 in CDMA2000 [3GPP2 C.S0047-0 v1.0].

6.5.6 MBCP Media Burst Idle message

The MBCP Media Burst Idle message is sent as an action from the PoC Server performing the Controlling PoC Function to participating PoC Clients signalling that no PoC Client has permission to send a Media Burst.

Table 7 "*MBCP Media Burst Idle message*" shows the content of the message.

Table 7: MBCP Media Burst Idle message

0										1										2										3									
0	1	2	3	4	5	6	7	8	9	0	1	2	3	4	5	6	7	8	9	0	1	2	3	4	5	6	7	8	9	0	1	2	3	4	5	6	7	8	9
V=2 P 0 0 1 0 1										PT=APP=204										length=2																			
SSRC of PoC Server performing the Controlling PoC Function																																							
																				name=PoC1																			

The following bit pattern in the subtype field SHALL be used for the MBCP Media Burst Idle message: 00101.

SSRC

The SSRC field SHALL carry the SSRC of the PoC Server performing the Controlling PoC Function.

6.5.7 MBCP Media Burst Taken message

The MBCP Media Burst Taken message is sent as an action from the PoC Server performing the Controlling PoC Function to inform non-requesting PoC Client(s) that someone has been granted permission to send a Media Burst.

Table 8 "*MBCP Media Burst Taken message*" shows the content of the message.

Table 8: MBCP Media Burst Taken message

0										1										2										3									
0	1	2	3	4	5	6	7	8	9	0	1	2	3	4	5	6	7	8	9	0	1	2	3	4	5	6	7	8	9	0	1	2	3	4	5	6	7	8	9
V=2 P subtype										PT=APP=204										length																			
SSRC of PoC Server performing the Controlling PoC Function																																							
name=PoC1																																							
SSRC of PoC Client granted a permission to send a Media Burst																																							
SDES item CNAME followed by SDES item NAME																																							
:																																							
P-count = 100										P-count-																													
										length = 2										Participants																			
Privacy = 105										Privacy-																													
										length = 2										Privacy request																			
Anonymous										Identity-																													
identity = 106										length										Unique anonymous identity																			

The following bit pattern in the subtype field SHALL be used for the MBCP Media Burst Taken message:

- 00010, when no acknowledgement reply is expected; and,
- 10010, when the sender of the MBCP Media Burst Taken message expects an acknowledgement reply.

SSRC

The SSRC field SHALL carry the SSRC of the PoC Server performing the Controlling PoC Function.

The SSRC field in the application dependent data of the Media Burst Taken message SHALL carry, either;

1. the SSRC of the PoC Client that has been granted a permission to send a Media Burst, if known by the PoC Server; or,
2. the SSRC field with all 32 bits set to '1'. In this case the receiving PoC Client SHALL ignore the SSRC field.

SDES item CNAME followed by SDES item NAME

In the application dependent data, the MBCP Media Burst Taken message SHALL carry a SSRC field and SDES items, CNAME and MAY carry SDES item NAME to identify the PoC Client that has been granted permission to send a Media Burst.

The MBCP Media Burst Taken message MAY also carry Participants item, Privacy item and Anonymous identity item. Therefore the length of the packet will vary depending on number of SDES items and the size of the SDES items and existence of the optional items.

The SDES item CNAME SHALL carry the URI of the PoC User that has been granted permission to send a Media Burst, if privacy was not requested or if privacy was requested, the PoC Server performing the Participating PoC Function is in the Media path and the MBCP Media Burst Taken message is sent by the PoC Server performing the Controlling PoC Function.

The SDES item CNAME SHALL carry the Anonymous PoC Address as defined in [OMA-PoC-CP] "*Anonymous PoC Address*" of the PoC User that has been granted permission to send a Media Burst, if privacy was requested and either the PoC Server performing the Participating PoC Function is not in the Media path or the MBCP Media Burst Taken message is sent by the PoC Server performing the Participating PoC Function.

The SDES item NAME, if known by the PoC Server and the sending of Nick Names is supported as specified in [OMA-PoC-CP] "*Nick Name*", SHALL carry the Nick Name of the PoC User that has been granted permission to send a Media Burst.

The SDES items and the proper encoding of the URI and the Nick Name are specified in [RFC3550]. The format of the SIP URI is defined in [RFC2396] and [RFC3261].

Participants

If the optional Participants item is included, it SHALL give the number of the Participants currently in the PoC Session in case the PoC Speech is the only Media in the PoC Session, otherwise the number of the Participants connected to the Media-floor Control Entity currently in the PoC Session.

The coding of the Participants is specified in subclause 6.5.1.2.1 "*P-count*".

Privacy

The Privacy SHALL give the information, if privacy is requested in the Sender Identification.

The coding of the Privacy is specified in subclause 6.5.1.2.6 "*Privacy*".

Anonymous identity

If the optional Anonymous identity item is included, it SHALL provide the unique Anonymous PoC Address of the Participant in the PoC Session.

6.5.8 MBCP Media Burst Revoke message

The MBCP Media Burst Revoke message is sent from the PoC Server performing the Controlling PoC Function to the PoC Client with permission to send a Media Burst to inform it stop sending a Media Burst.

Table 9 "*MBCP Media Burst Revoke message*" shows the content of the message.

Table 9: MBCP Media Burst Revoke message

0																1																2																3															
0	1	2	3	4	5	6	7	8	9	0	1	2	3	4	5	6	7	8	9	0	1	2	3	4	5	6	7	8	9	0	1																																
V=2 P 0 0 1 1 0																PT=APP=204																length																															
SSRC of PoC Server performing the Controlling PoC Function																																																															
name=PoC1																																																															
reason code																additional information																																															

The following bit pattern in the subtype field SHALL be used for the MBCP Media Burst Revoke message: 00110.

SSRC

The SSRC field SHALL carry the SSRC of the PoC Server performing the Controlling PoC Function.

Reason code and additional information

The application-dependent data field SHALL carry a reason in the reason code field for why the PoC Server performing the Controlling PoC Function wants the PoC Client to stop sending a Media Burst. Also additional information can be carried in the additional information field, therefore the length of the packet can vary depending on the value of the reason code field.

The coding of reason code and additional information is specified in subclause 6.5.8.1 "Reason codes".

6.5.8.1 Reason codes

The first 16 bits in the application-dependent data field is used for the reason code field. Thereafter additional information is added. Depending on the value of the reason code field, the number of octets conveying additional information differs.

6.5.8.1.1 Only one PoC User

Indicates that the PoC Client is the only PoC Client in the Session or the only Participant connected to a Media-floor Control Entity.

The value of the reason code field SHALL be: 1.

No additional information SHALL be included. Hence, the first 16 bits in the additional information field SHALL be populated with zeros.

6.5.8.1.2 Media Burst too long

Indicates that the PoC User has talked too long, i.e. the stop-talking timer has expired.

The value of the reason code field SHALL be: 2.

As additional information the additional information field carries a retry-after field where the 16 bits in the additional information field is an integer number giving the time in seconds when the PoC Client can request permission to send a Media Burst again. The timer length should be a few seconds longer than the timer value for the retry-after timer in the PoC Server performing the Controlling PoC Function.

NOTE 1: $T_{12} = T_9 + \Delta$ (a few seconds) where $[T_3 - (\text{average round trip time from PoC Client to Controlling PoC Function} + \text{average round trip time from Controlling PoC Function to PoC Client})] \leq \Delta \leq T_3$.

Thus, a PoC Client that receives a MBCP Media Burst Revoke message with a retry-after field that is non-zero SHOULD NOT try to transmit anything before the time given in the retry-after field has expired. Therefore, a retry-after timer in the PoC Client is needed.

NOTE 2: The retry-after timer functionality in the PoC Server performing the Controlling PoC Function and in the PoC Client is used to prevent a PoC User to immediately request permission to send a Media Burst after it has received a MBCP Media Burst Revoke message.

6.5.8.1.3 No permission to send a Media Burst

Indicates that the PoC Client does not have permission to send a Media Burst even though the PoC Client is in the "has permission state" and transmits RTP Media packets.

Temporary loss of coverage for a PoC Client with permission to send a Media Burst can result in this case of different states in the PoC Client and the PoC Server performing the Controlling PoC Function. This happens when the loss of coverage is longer than the timer value of the T1 (End of RTP Media) timer".

The value of the reason code field SHALL be: 3.

No additional information SHALL be included. Hence, the first 16 bits in the additional information field SHALL be populated with zeros.

6.5.8.1.4 Media Burst pre-empted

Indicates that the PoC Client's permission to send a Media Burst is being pre-empted.

The value of the reason code field SHALL be: 4.

No additional information SHALL be included. Hence, the first 16 bits in the additional information field SHALL be populated with zeros.

6.5.8.1.5 Media-floor occupied too long

Indicates that the PoC Client has occupied the Media-floor too long.

The PoC Client is expected to release the Media-floor using the MBCP Media Burst Release message.

The value of the reason code field SHALL be: 5.

6.5.8.1.6 No resources available

Indicates that the PoC Server performing the Controlling PoC Function cannot grant the Media Burst request due to congestion.

The value of the reason code field SHALL be: 6.

6.5.8.1.7 Other reason

Indicates that the PoC Server performing the Controlling PoC Function does not grant the Media Burst request due to the PoC Server local policy.

The value of the reason code field SHALL be: 255.

6.5.9 MBCP Media Burst Acknowledgement message

The MBCP Media Burst Acknowledgement message is a response from a PoC Client to a message that has been sent.

Table 10 "MBCP Media Burst Acknowledgement" shows the content of the message.

Table 10: MBCP Media Burst Acknowledgement

0											1											2											3										
0	1	2	3	4	5	6	7	8	9	0	1	2	3	4	5	6	7	8	9	0	1	2	3	4	5	6	7	8	9	0	1												
V=2 P 0 0 1 1 1											PT=APP=204											length=3																					
SSRC of PoC Client sending the acknowledgement message																																											
											name=PoC1																																
subtype											reason code											! padding																					

The following bit pattern in the subtype field SHALL be used for the MBCP Media Burst Acknowledgement message: 00111.

SSRC

The SSRC field shall carry the SSRC of the PoC Client that is sending the acknowledgement.

Subtype

The application dependent data subtype field SHALL be the value of the subtype field found in the message that is being acknowledged.

Reason codes

The application dependent data area contains one or two defined fields: subtype followed by 11 bits of reason code field followed by 16 padding bits. If the reason code field is not used the corresponding field is filled by padding bits as specified in subclause 6.5.1 'RTP: APP message format'.

The coding of reason code is specified in subclause 6.5.9.1 "Reason codes".

Padding

The last 16 bits are padding bits and SHALL be set to zero.

6.5.9.1 Reason codes

6.5.9.1.1 Accepted

Indicates that the PoC Client has accepted the incoming PoC Session.

The reason code SHALL be: 0 (decimal value).

6.5.9.1.2 Busy

Indicates that the PoC Client has not accepted the incoming PoC Session, because it is busy.

The reason code SHALL be: 1 (decimal value).

6.5.9.1.3 Not accepted

Indicates that the PoC Client has not accepted the incoming PoC Session.

The reason code SHALL be: 2 (decimal value).

6.5.10 MBCP Media Burst Request Queue Status Request message

NOTE: There are no procedures defined for the MBCP Media Burst Request Queue Status Request message.

The MBCP Media Burst Request Queue Status Request message is a request from a PoC Client to get information about the PoC Client's position in the Media Burst request queue.

Table 11 "*Media Burst Request Queue Status Request message*" shows the content of the message.

Table 11: Media Burst Request Queue Status Request message

0										1										2										3									
0	1	2	3	4	5	6	7	8	9	0	1	2	3	4	5	6	7	8	9	0	1	2	3	4	5	6	7	8	9	0	1	2	3	4	5	6	7	8	9
V=2 P 01000										PT=APP=204										length=2																			
SSRC of PoC Client requesting queue status information																																							
															name=PoC1																								

The following bit pattern in the subtype field SHALL be used for the Media Burst Request Queue Status Request message: 01000.

SSRC

The SSRC field SHALL carry the SSRC of the PoC Client that is requesting information about its position in the Media Burst request queue.

6.5.11 MBCP Media Burst Request Queue Status message

The MBCP Media Burst Request Queue Status message is sent by the PoC Server performing the Controlling PoC Function to notify the PoC Client of its position in the Media Burst request queue. The message is sent in response to a MBCP Media Burst Request message if the request is queued. It can be sent at other times, e.g. if the PoC Client is removed from the Media Burst request queue or if the position or priority of the request is changed.

Table 12 "*MBCP Media Burst Request Queue Status message*" shows the content of the message.

Table 12: MBCP Media Burst Request Queue Status message

0								1								2								3							
0	1	2	3	4	5	6	7	8	9	0	1	2	3	4	5	6	7	8	9	0	1	2	3	4	5	6	7	8	9	0	1
V=2 P 0 1 0 0 1								PT=APP=204								length=3															
SSRC of PoC Server performing the Controlling PoC Function																															
name=PoC1																															
Priority				Queue position								padding																			

The following bit pattern in the subtype field SHALL be used for the MBCP Media Burst Request Queue Status message: 01001.

SSRC

The SSRC field SHALL carry the SSRC of the PoC Server performing the Controlling PoC Function.

Priority

The priority level field is a 1 byte field which defines the priority level that is currently held by the last request received. The defined priority levels that can be included in a MBCP Media Burst Request Queue Status message are:

- 1 – normal priority
- 2 – high priority
- 3 – pre-emptive priority

The default value if the MBCP priority option was not negotiated at PoC Session setup shall be 1 – normal priority.

All other values are reserved.

Queue position

The queue position field defines the number of PoC Clients in the MBCP Media Burst Request Queue Status message that are ahead of the PoC Client. The queue position field SHALL have the value 65534 if the PoC Client is not queued. The queue position field SHALL have the max value (65535) if the PoC Client is queued but the PoC Server is unable to determine the queue position or if PoC Server policy is not to release information of the queue position to the PoC Client.

Padding

The last 8 bits are padding bits and SHALL be set to zero.

6.5.12 MBCP Disconnect message

The MBCP Disconnect message is sent by the PoC Server performing the Participating PoC Function to the PoC Client to indicate that the PoC Session using a Pre-established Session has been released.

Table 13 "MBCP Disconnect message" shows the content of the message.

Table 13: MBCP Disconnect message

0										1										2										3									
0	1	2	3	4	5	6	7	8	9	0	1	2	3	4	5	6	7	8	9	0	1	2	3	4	5	6	7	8	9	0	1	2	3	4	5	6	7	8	9
V=2 P 0 1 0 1 1										PT=APP=204										length=2																			
SSRC of PoC Server performing the Participating PoC Function																																							
name=PoC1																																							
Reason-Header										Reason-Header-																													
= 109										length																													
Reason-Header-Value																																							

The following bit pattern in the subtype field SHALL be used for the MBCP Disconnect message: 01011.

SSRC

The SSRC field SHALL carry the SSRC of the PoC Server performing the Participating PoC Function.

Reason-Header:

In case the optional Reason header item is included, it SHALL provide the value of the Reason header as specified in [RFC 4411] of a received SIP BYE request that caused the release of the PoC User. The coding of the Reason header item is specified in subclause 6.5.1.2.10 "Reason header".

6.5.13 MBCP Connect message

The MBCP Connect message is sent as an action from the PoC Server performing the Participating PoC Function to inform PoC Client(s) using Pre-established Session that it has been connected to a PoC Session.

Using the Pre-established Session procedure, the MBCP Connect message informs a terminating PoC Client(s) that it has been invited to a PoC Session and provides the PoC Session Identity, or an originating PoC Client that it has successfully established a PoC Session.

In case the PoC Service Setting is set 'not active' or unavailable for the invited party identity information feature, the PoC Server performing the Participating PoC Function SHALL NOT include invited party identity information in the MBCP Connect message.

Table 14 "MBCP Connect message" shows the content of the message.

Table 14: MBCP Connect message

0										1										2										3									
0	1	2	3	4	5	6	7	8	9	0	1	2	3	4	5	6	7	8	9	0	1	2	3	4	5	6	7	8	9	0	1	2	3	4	5	6	7	8	9
V=2 P 0 1 1 1 1										PT=APP=204										length																			
SSRC of PoC Server performing the Participating PoC Function																																							
name=PoC1																																							
SDES item content										Session type										Add. indic.																			
SDES items																																							
:																																							
P-count = 100										P-count-																													
length = 2										Participants																													
MBCP-restrict										MBCP-restrict																													
= 108										-length = 2										MBCP-restrict-value																			
Media-Streams										Media-Streams-																													
= 107										length = n																													
Media-Streams-value																																							

The following bit pattern in the subtype field SHALL be used for the MBCP Connect message: 01111.

SSRC

The SSRC field SHALL carry the SSRC of the PoC Server performing the Participating PoC Function.

SDES item content

SDES item content includes the bit pattern ABCDEFXXXXXXXXXXXX, where each bit indicates if the optional SDES item is included or not (1= included, 0=not included) according to the description below:

A= Identity of the Inviting PoC Client.

B= The Nick Name provided by the Inviting PoC Client.

C= PoC Session Identity.

NOTE 1: The PoC Session Identity matches the PoC Session Identity the PoC Server performing the Controlling PoC Function returns in the contact header of the SIP 200 "OK" to the PoC Server performing the Participating PoC Function.

D= The PoC Group Name.

E=PoC Group Identity.

F= Invited party identity information.

X= for future use (set to 0).

Session type

Session type indicates the Session Type uri parameter as follows:

00000000 = no session type

00000001 = 1-1

00000010 = adhoc

00000011 = prearranged

00000100 = chat

The rest of the values are reserved for future use.

Additional indications

Additional indications includes the bit pattern abcdxxxx, where each bit indicates the functionality in the following way:

a= Manual Answer Override Indication, value 1, if included and value 0, if not included.

b=dispatcher, value 1, if a Dispatch PoC Session and value 0 if not a Dispatch PoC Session.

c=role, value 1 for a PoC Dispatcher role and value 0 for a PoC Fleet Member role.

d=type, value 0 indicates entire-group and value 1 indicates a subgroup.

NOTE 2: The bits b, c and d are valid only if the Contact header of the SIP 200 "OK" from the PoC Server performing the Participating Function included the SIP '+g.poc.dispatcher' feature tag during the Pre-established Session establishment, as specified in the [OMA-PoC-CP] subclause 7.3.1.2 "*Pre-established Session*".

e= Discrete-Media-feature-tag-indication, value 1 if the feature tag '+g.poc.discretedia' was included in the SIP INVITE request received from the PoC Server performing the Controlling PoC Function, and value 0, if not included.

x= for future use (set to 0).

SDES items

The SDES items field (in the order presented)

- SHALL include a CNAME item to identify the PoC Client initiating the PoC Session, if privacy was not requested;
- MAY include a NAME item to identify the Nick Name of the PoC Client initiating the PoC Session, if privacy was not requested;
- SHALL include a CNAME item to identify the PoC Session Identity;

- MAY include a NAME item to identify the PoC Group Name, if the PoC Session is of type prearranged or chat;
- SHALL include a CNAME of the PoC Group Identity, if the PoC Session is of type prearranged or chat; and,
- MAY include, if privacy is not requested by the Inviting PoC Client, a CNAME item for each Invited PoC Client for the Ad-hoc PoC Group Session and 1-1 PoC Session.

NOTE 3: Maximum size of SDES items field can be limited.

NOTE 4: The "copyControl" attribute value is not required to be included in the MBCP Connect message.

NOTE 5: If there is at least one privacy-requested Invited PoC Client, the total number of the privacy-requested Invited PoC Client(s), which is to be presented to the Invited PoC User, is calculated by subtracting the total number of non-privacy-requested Invited PoC Clients included in the SDES items field from the P-count field value.

If the PoC Client that initiated the PoC Session has requested privacy an anonymous URI SHALL be included instead of the PoC User's PoC Address in CNAME. The anonymous URI SHALL follow the guidelines defined in [RFC3323] for anonymous URIs and be the same as in Participant information specified in [OMA-CP] "*Generating a SIP NOTIFY request*".

The SDES items and the proper encoding of the URI are specified in [RFC3550].

Participants

In case the optional Participants item is included, it SHALL give the number of the Participants currently in the PoC Session in case the PoC Speech is the only Media in the PoC Session, otherwise the number of the Participants connected to the Media-floor Control Entity currently in the PoC Session. The coding of the Participants is specified in subclause 6.5.1.2.1 "*P-count*".

MBCP-restrict

In case the optional MBCP-restrict item is included, it SHALL indicate the usage of the Media-floor Control Protocol extensions for the Media-floor Control Entity of the PoC Session associated with the Pre-established Session. The coding of the MBCP-restrict is specified in subclause 6.5.1.2.8 "*MBCP-restrict*".

Media-Streams

In case the optional Media-Streams item is included, it SHALL indicate the usage of the Media Streams of the Pre-established Session in the associated PoC Session. The coding of the Media-Streams is specified in subclause 6.5.1.2.9 "*Media-Streams*".

6.5.14 Subtype bit pattern reserved for future use

All bit patterns in the subtype field that have not been specified above are reserved for future use.

6.6 Procedures at the UE PoC Box

6.6.1 UE PoC Box procedures at PoC Session initialization

When a PoC Session is established for a UE PoC Box, a new instance of the '*UE PoC Box control state diagram – Continuous Media*' is created for each agreed Media-floor Control Entity and the Media Streams not bound to a Media-floor Control Entity start to be recorded.

6.6.2 UE PoC Box procedures at PoC Session release

PoC Session release (whether it is initiated by the UE PoC Box or not) is a two-stage procedure.

In the first stage, the UE PoC Box stops recording Media.

In the second stage, when the Control Plane has determined that the PoC Session has been released, the corresponding instance of the PoC Session control state machine for each Media-floor Control Entity is also terminated and the UE PoC Box releases all the resources needed for recording Media.

The User Plane can initiate the first stage, but the Control Plane always initiates the second stage.

6.6.3 UE PoC Box procedures at PoC Session modification

When a new Media-floor Control Entity is added as specified in [OMA-PoC-CP] "*UE PoC Box receiving a request to add and disconnect Media Streams*" a new instance of the UE PoC Box control state diagram are created for the Media-floor Control Entity is started.

If removing a Media-floor Control Entity or changing the Media-floor Control Entity bindings or if disconnecting from an existing Media Type the UE PoC Box:

1. SHALL release the permission to send Media as specified in subclause 6.7.4.4.2 "*Send MBCP Media Burst Release message (S: MB_Release)*" if the UE PoC Box has the permission to send Media; and,
2. SHALL stop sending Media Burst Control messages associated with the Media-floor Control Entity.

NOTE 1: Received Media or Media Burst Control messages are handled as specified in 6.7.4 "*PoC Session control state diagram – basic*".

When disconnecting from an existing Media Type is agreed, the UE PoC Box SHALL release resources used by the disconnected Media Type.

When removing of an existing Media-floor Control Entity is agreed, the corresponding instance of the PoC Client state machine diagram for basic operation or the PoC Session control state machine for queuing SHALL be terminated.

When the Media-floor Control bindings are changed the UE PoC Box SHALL NOT send Media and Media Burst Control messages according to the old binding.

The UE PoC Box SHALL start to use changed Media Parameters, codecs or Media formats as soon as they are agreed.

NOTE 2: The ports to send Media and MBCP messages to is negotiated in the [OMA-PoC-CP] "*UE PoC Box specific procedures*".

6.6.4 UE PoC Box control state diagram – Continuous Media

The UE PoC Box SHALL support the state diagram and the state transitions specified in this subclause when Continuous Media or when Discrete Media bound to a Media-floor Control Entity or both is negotiated as specified in the [OMA-PoC-CP] "*UE PoC Box Invited to a PoC Session*".

NOTE: The sending or receiving of reports related to Discrete Media are described in subclauses 7.12 "*Discrete Media Transfer Final Report*" and 7.13 "*Discrete Media Transfer Progress Report*".

Figure 13 "*UE PoC Box control state diagram*" shows the state diagram.

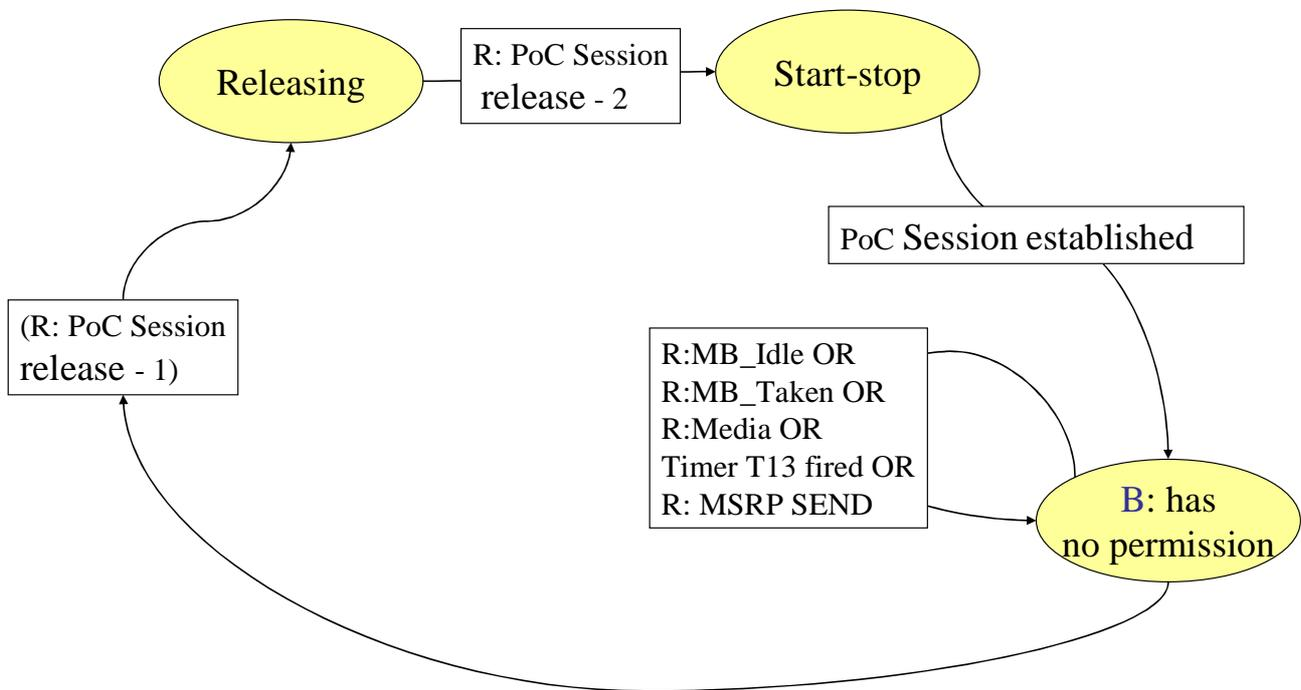

Figure 13: UE PoC Box control state diagram – Continuous Media

State details are explained in the following subclauses.

If a MBCP message, a MSRP request, a MSRP response or RTP Media packet arrives in any state and there is no procedure specified for it in the subclauses below the UE PoC Box SHALL discard the MBCP message, the MSRP request, the MSRP response or the RTP Media packet and SHALL remain in the current state.

When a UE PoC Box negotiates the Talk Burst Control Protocol as specified in [OMA-PoC-1-UP] instead of the Media Burst Control Protocol, the UE PoC Box.

1. SHALL handle the received TBCP message as the MBCP message of the same subtype; and,
2. SHALL generate and send in the subclauses below the TBCP message instead of the MBCP message as follows:
 - a. the TBCP message of the same subtype is generated; and,
 - b. the TBCP message fields with the same content are included into the TBCP message

6.6.4.1 State 'Start-stop'

In this state no Media-floor Control Entity exists.

6.6.4.1.1 PoC Session established

When a PoC Session is established the terminating UE PoC Box:

1. SHALL create an instance of a 'UE PoC Box control state diagram'; and,
2. SHALL enter the 'B: has no permission' state.

NOTE: From a UE PoC Box perspective the PoC Session is established when the UE PoC Box sends the SIP 200 "OK" response.

6.6.4.2 State: 'B: has no permission'

The 'B: has no permission' state is a stable state and the UE PoC Box uses this state when the UE PoC Box is in an established PoC Session.

In this state the UE PoC Box can receive RTP Media packets, MSRP SEND requests and MBCP Media Burst Control messages.

In this state the T13 (end of RTP Media) can be running.

6.6.4.2.1 Receive MBCP Media Burst Idle message (R: MB_Idle)

Upon receiving MBCP Media Burst Idle message the UE PoC Box:

1. SHALL stop the optional timer T13 (end of RTP Media), if it is running; and,
2. SHALL remain in the 'B: has no permission' state.

6.6.4.2.2 Receive MBCP Media Burst Taken message (R: MB_Taken)

Upon receiving of the MBCP Media Burst Taken message the UE PoC Box:

1. SHALL send an MBCP Media Burst Acknowledgement message if the MBCP Media Burst Taken message indicates an acknowledgement reply;
2. SHALL store the PoC Address or Nick Name or both if they are included in the message; of the PoC User granted permission to send a Media Burst as described in subclause 8.4 "*Sender Identification in the PoC Box*";
3. SHALL store the mapping between the SSRC of the PoC Client granted permission to send a Media Burst and the PoC Address or Nick Name or both, if they are included in the message;
4. SHALL store a timestamp containing the date and time the MBCP Media Burst Taken message was received;
5. SHOULD start/restart the optional timer T13 (end of RTP Media) for the Active PoC Session if Continuous Media is bound to the Media Control Entity; and,
6. SHALL remain in the 'B: has no permission' state.

6.6.4.2.3 Receive RTP Media packets (R: Media)

Upon receiving RTP Media packets the UE PoC Box:

1. SHALL store the Media;
2. SHALL associate the PoC Address or Nick Name or both based on the SSRC of the sending PoC Client with the stored Media, if mapping between those exists in UE PoC Box;
3. SHALL associate with the stored Media the timestamp that was stored when the Media Burst Taken message was received;

NOTE: In the event that the Media Burst Taken message is not received the timestamp associated with the stored Media can be based upon the time that the first RTP Media packet is received.

4. SHOULD restart/start the optional timer T13 (end of RTP Media); and,
5. SHALL remain in the 'B: has no permission' state.

6.6.4.2.4 T13 (end of RTP Media) timer fired

On firing of T13 (end of RTP Media) timer, the UE PoC Box:

1. SHALL remain in the 'B: has no permission' state.

6.6.4.2.5 Receive PoC Session release – 1 (R: PoC Session release - 1)

Upon receiving a PoC Session release stage 1 request from the Control Plane, the UE PoC Box:

1. SHALL regard the receiving of RTP Media packets as completed; and,
2. SHALL enter the 'Releasing' state.

6.6.4.2.6 Receiving a MSRP SEND request (R: MSRP SEND)

If the UE PoC Box supports receiving Discrete Media then upon receiving an MSRP SEND request the UE PoC Box:

1. SHALL generate and send a MSRP 200 "OK" response according to rules and procedures of [OMA-PoC-IM];
2. SHALL store the received content of the MSRP SEND request;
3. SHALL store the PoC Address or Nick Name or both if they are included in the message retrieved from the message/cpim From header in the MSRP SEND body as described in subclause 8.4 "*Sender Identification in the PoC Box*" and associate with the content of the MSRP SEND request;
4. SHALL associate with the stored content of the MSRP SEND request the timestamp that was stored when the Media Burst Taken message was received, and,

NOTE: In the event that the Media Burst Taken message is not received the timestamp associated with the stored Media can be based upon the time that the first MSRP SEND request is received.

5. SHALL remain in the 'B: has no permission' state.

6.6.4.3 State: 'Releasing'

The 'Releasing' state is a transition state. The UE PoC Box uses this state while waiting for Control Plane to finalize the disconnection of a PoC Session.

6.6.4.3.1 Receive PoC Session release – 2 (R: PoC Session release - 2)

Upon receiving a PoC Session release stage 2 request from the Control Plane, the UE PoC Box:

1. SHALL release all resources including any running timers associated with the PoC Session; and,
2. SHALL enter the 'Start-stop' state and terminate the 'UE PoC Box control state diagram – Continuous Media' state machine.

6.6.5 UE PoC Box procedures for Media Stream not bound to Media-floor Control Entity

NOTE: The Discrete Media can also be recorded by the [OMA-PoC-CP] "*UE PoC Box receiving a SIP MESSAGE request*" if received in the SIP MESSAGE request.

6.6.5.1.1 Receiving a MSRP SEND request

If the UE PoC Box supports receiving Discrete Media then upon receiving an MSRP SEND request in the Media Stream not bound to a Media-floor Control Entity, the UE PoC Box:

1. SHALL generate and send a MSRP 200 "OK" response according to rules and procedures of [OMA-PoC-IM];
2. SHALL store the received content of the MSRP SEND request;
3. SHALL store the PoC Address or Nick Name or both if they are included in the message, retrieved from the message/cpim From header in the MSRP SEND body as described in subclause 8.4 "*Sender Identification in the PoC Box*"; and,
4. SHALL store a timestamp containing the date and time the MSRP SEND request message was received.

NOTE: The sending of reports related to Discrete Media is described in subclauses 7.12 "*Discrete Media Transfer Final Report*" and 7.13 "*Discrete Media Transfer Progress Report*".

6.7 Procedures at the NW PoC Box

6.7.1 NW PoC Box procedures at PoC Session initialization

When a PoC Session is established for a NW PoC Box, a new instance of the '*NW PoC Box control state diagram – Continuous Media*' is created for each agreed Media-floor Control Entity and the Media Streams not bound to a Media-floor Control Entity start to be recorded.

The state machine is defined in subclause 6.7.4 "*NW PoC Box control state diagram*".

Before the first RTP Media packet, RTCP packet or Media Burst Control Protocol message is sent by a NW PoC Box in a PoC Session, the NW PoC Box assigns itself a SSRC identifier for the PoC Session. If NW PoC Box supports the PoC Sessions initiated by Inviting PoC Client compliant only to the PoC version 1.0 specification and if the received PoC Session invitation indicates that the Inviting PoC Client is compliant only to the PoC version 1.0 specification, the NW PoC Box discards the received Media until the NW PoC Box finishes sending the Media indicating the recording.

The procedures for the Media Streams not bound to a Media-floor Control Entity are described in subclause 6.7.5 "*NW PoC Box procedures for Media Stream not bound to Media-floor Control Entity*".

6.7.2 NW PoC Box procedures at PoC Session release

PoC Session release (whether it is initiated by the NW PoC Box or not) is a two-stage procedure.

In the first stage, the NW PoC Box stops sending MBCP messages for each Media-floor Control Entity and sending or recording Media for each Media Type.

In the second stage, when the Control Plane has determined that the PoC Session has been released, the corresponding instance of the PoC Session control state machine for each Media-floor Control Entity are also terminated and the NW PoC Box releases all the resources needed by the used Media Types.

The User Plane can initiate the first stage, but the Control Plane always initiates the second stage.

6.7.3 NW PoC Box procedures at PoC Session modification

When a new Media-floor Control Entity is added as specified in [OMA-PoC-CP] "*NW PoC Box receiving a request to add and disconnect Media Streams*" a new instance of the '*NW PoC Box control state diagram – Continuous Media*' or '*NW PoC Box control state diagram – Discrete Media*' or both are created for the Media-floor Control Entity.

When removing a Media-floor Control Entity or changing the Media-floor Control Entity bindings or when disconnecting from an existing Media Type the NW PoC Box:

1. SHALL release the permission to send Media as specified in subclause 6.7.4.4.2 "*Send MBCP Media Burst Release message (S: MB_Release)*" if the NW PoC Box has the permission to send Media; and,
2. SHALL stop sending Media Burst Control messages associated with the Media-floor Control Entity.

NOTE 1: Received Media or Media Burst Control messages are handled as specified in 6.7.4 "*PoC Session control state diagram – basic*".

When disconnecting from an existing Media Type is agreed, the NW PoC Box SHALL release resources used by the disconnected Media Type.

When removing of an existing Media-floor Control Entity is agreed, the corresponding instance of the PoC Client state machine diagram for basic operation or the PoC Session control state machine for queuing SHALL be terminated.

When the Media-floor Control bindings are changed the NW PoC Box SHALL NOT send Media and Media Burst Control messages according to the old binding.

The NW PoC Box SHALL start to use changed Media Parameters, codecs or Media formats as soon as they are agreed.

NOTE 2: The ports to send Media and MBP messages to is negotiated in the [OMA-PoC-CP] "*NW PoC Box specific procedures*".

6.7.4 NW PoC Box control state diagram

The NW PoC Box SHALL support the state diagram and the state transitions specified in this subclause when Continuous Media or Discrete Media or both are bound to the Media-floor Control Entity.

NOTE: The sending or receiving of reports related to Discrete Media are described in subclauses 7.12 "*Discrete Media Final Report*" and 7.13 "*Discrete Media Transfer Progress Report*".

Figure 14 "*NW PoC Box control state diagram*" shows the state diagram.

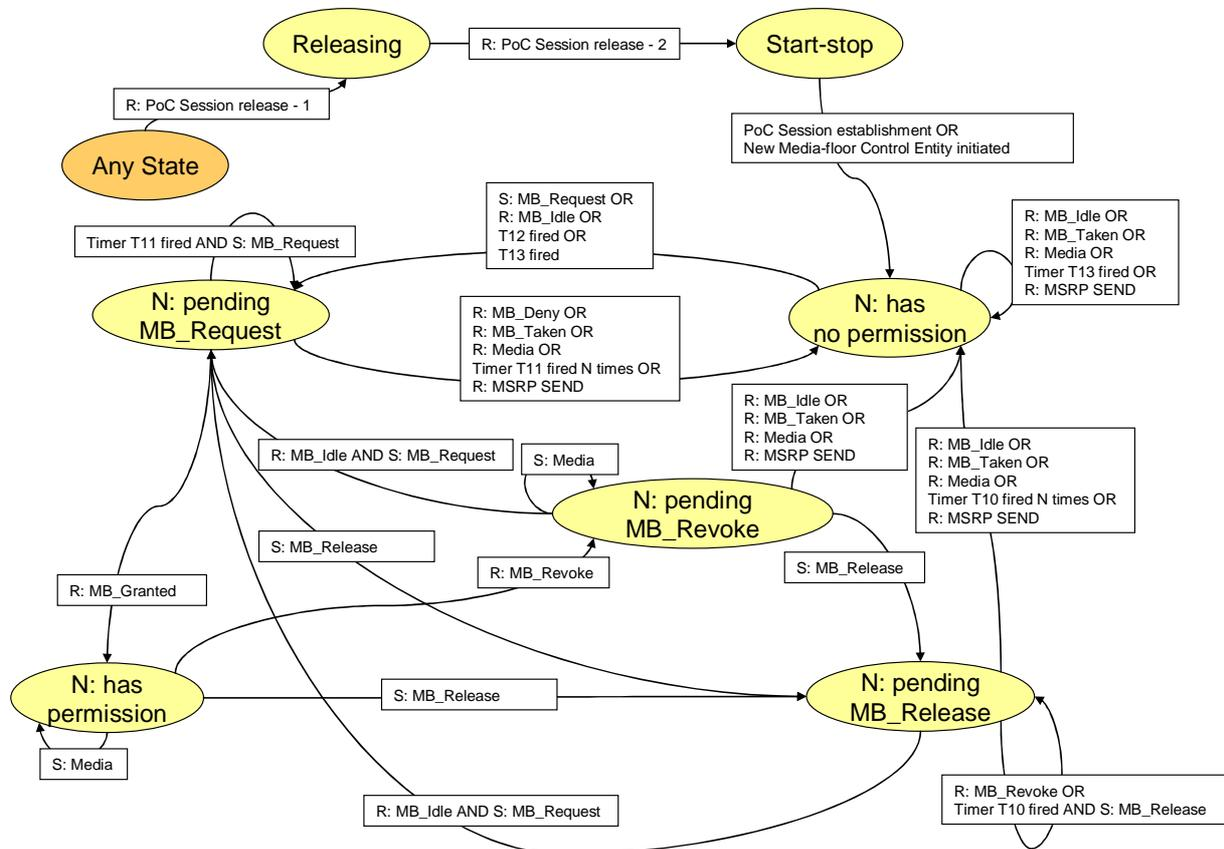

Figure 14: NW PoC Box control state diagram

State details are explained in the following subclauses.

If an MBCP message, RTP Media packet or MSRP SEND request arrives in any state and there is no procedure specified for it in the subclauses below the NW PoC Box SHALL discard the MBCP message or RTP Media packet or MSRP SEND request and SHALL remain in the current state.

When a NW PoC Box negotiates the Talk Burst Control Protocol as specified in [OMA-PoC-1-UP] instead of the Media Burst Control Protocol, the NW PoC Box.

1. SHALL handle the received TBCP message as the MBCP message of the same subtype; and,
2. SHALL generate and send in the subclauses below the TBCP message instead of the MBCP message as follows:
 - a. the TBCP message of the same subtype is generated; and,
 - b. the TBCP message fields with the same content are included into the TBCP message.

6.7.4.1 State 'Start-stop'

In this state no Media-floor Control Entity exists.

6.7.4.1.1 PoC Session established

When a PoC Session is established as specified in [OMA-PoC-CP] "*NW PoC Box invited to PoC Session*" the terminating NW PoC Box:

1. SHALL create an instance of a 'NW PoC Box state transition diagram' state machine; and,
2. SHALL enter the 'N: has no permission' state.

NOTE: From a NW PoC Box perspective the PoC Session is established when the NW PoC Box sends the SIP 200 "OK" response.

6.7.4.1.2 New Media-floor Control Entity initiated

When a new Media-floor Control Entity is negotiated during an ongoing PoC Session as specified in [OMA-PoC-CP] "*NW PoC Box PoC Session modification*" the NW PoC Box:

1. SHALL enter the 'N: has no permission' state.

6.7.4.2 State: 'N: has no permission'

The 'N: has no permission' state is a stable state and the NW PoC Box uses this state when the NW PoC Box is not sending RTP Media packets or is not waiting for an MBCP message response.

In this state the NW PoC Box can receive RTP Media packets, MSRP SEND request or MBCP Media Burst Control messages.

The timer T13 (end of RTP Media) and timer T12 (PoC Client retry-after) can be running in this state.

6.7.4.2.1 Receive MBCP Media Burst Idle message (R: MB_Idle)

Upon receiving MBCP Media Burst Idle message the NW PoC Box:

1. SHALL stop the timer T13 (end of RTP Media), if it is running; and,
2. if the received PoC Session invitation indicates that the Inviting PoC Client is compliant only to the PoC version 1.0 specification, if the NW PoC Box has not finished sending the Media indicating the recording yet and if timer T12 (PoC Client retry-after) is not running,
 - a. SHALL send the MBCP Media Burst Request message toward the PoC Server;
 - b. SHALL start timer T11 (Media Burst Request); and,
 - c. SHALL enter the 'N: pending MB_Request' state.
3. otherwise
 - a. SHALL remain in the 'N: has no permission' state.

6.7.4.2.2 Receive MBCP Media Burst Taken message (R: MB_Taken)

Upon receiving of the MBCP Media Burst Taken message the NW PoC Box:

1. if the received PoC Session invitation indicated that the Inviting PoC Client is compliant only to the PoC version 1.0 specification and if the NW PoC Box has already sent the Media indicating recording or if the received PoC Session invitation did not indicate that the Inviting PoC Client is compliant only to the PoC version 1.0 specification,
 - a. SHALL store the PoC Address or Nick Name or both if they are included in the message; of the PoC User granted permission to send a Media Burst as described in subclause 8.4 "*Sender Identification in the PoC Box*", if privacy is not requested;

- b. SHALL store the mapping between the SSRC of the PoC Client granted a permission to send a Media Burst and the PoC Address or Nick Name or both, if they are included in the message; and,
 - c. SHALL store a timestamp containing the date and time the MBCP Media Burst Taken message was received.
2. SHALL start the timer T13 (end of RTP Media) for the Active PoC Session when Continuous Media is bound to the Media-floor Control Entity; and,
3. SHALL remain in the 'N: has no permission' state.

6.7.4.2.3 Receive RTP Media packets (R: Media)

Upon receiving RTP Media packets the NW PoC Box:

1. if the received PoC Session invitation indicated that the Inviting PoC Client is compliant only to the PoC version 1.0 specification and if the NW PoC Box has not sent the Media indicating recording yet,
 - a. SHALL discard the Media;
2. otherwise
 - a. SHALL store the Media;
 - b. SHALL associate the PoC Address or Nick Name or both based on the SSRC of the sending PoC Client with the stored Media, if mapping between those exists in NW PoC Box and if privacy is not requested and,
 - c. SHALL associate with the stored Media the timestamp that was stored when the Media Burst Taken message was received.

NOTE: In the event that the Media Burst Taken message is not received the timestamp associated with the stored Media can be based upon the time that the first RTP Media packet is received.

3. SHALL restart/start the optional timer T13 (end of RTP Media); and,
 4. SHALL remain in the 'N: has no permission' state.

6.7.4.2.4 Send MBCP Media Burst Request message (S: MB_Request)

Upon receiving an indication to request permission to send Media and if timer T12 (Retry after) is not running the NW PoC Box:

1. in the case of a 1-1 PoC Session
 - a. SHALL send the MBCP Media Burst Request message toward the PoC Server;
 - b. SHALL stop the timer T13 (end of RTP Media), if it is running;
 - c. SHALL start timer T11 (Media Burst Request); and,
 - d. SHALL enter the 'U: pending MB_Request' state.
2. in the case of PoC Group Session with more than one Participant
 - a. SHALL ignore the indication to send Media; and,
 - b. SHALL remain in the 'N: has no permission' state.

NOTE: In this Release of the specification the PoC Box is not allowed to request permission to send Media unless it is a 1-1 PoC Session.

6.7.4.2.5 T13 (end of RTP Media) timer fired

On firing of T13 (end of RTP Media) timer, the NW PoC Box:

1. if the received PoC Session invitation indicates that the Inviting PoC Client is compliant only to the PoC version 1.0 specification, if the NW PoC Box has not finished sending the Media indicating the recording yet and if timer T12 (PoC Client retry-after) is not running,
 - a. SHALL send the MBCP Media Burst Request message toward the PoC Server;
 - b. SHALL start timer T11 (Media Burst Request); and,
 - c. SHALL enter the 'N: pending MB_Request' state.
2. otherwise
 - a. SHALL remain in the 'N: has no permission' state.

6.7.4.2.6 Receiving a MSRP SEND request (R: MSRP SEND)

Upon receiving an MSRP SEND request the NW PoC Box:

1. SHALL generate and send a MSRP 200 "OK" response according to rules and procedures of [OMA-PoC-IM];
2. SHALL store the received content of the MSRP SEND request;
3. SHALL store the PoC Address or Nick Name or both if they are included in the message retrieved from the message/cpim From header in the MSRP SEND body as described in subclause 8.4 "*Sender Identification in the PoC Box*" and associate with the content of the MSRP SEND request if privacy is not requested;
4. SHALL associate with the stored content of the MSRP SEND request the timestamp that was stored when the Media Burst Taken message was received; and,

NOTE: In the event that the Media Burst Taken message is not received the timestamp associated with the stored Media can be based upon the time that the first MSRP SEND request is received.

5. SHALL remain in the 'N: has no permission' state.

6.7.4.2.7 T12 (PoC Client retry-after) timer fired

On firing of timer T12 (PoC Client retry-after), the NW PoC Box:

1. if the received PoC Session invitation indicates that the Inviting PoC Client is compliant only to the PoC version 1.0 specification, if the NW PoC Box has not finished sending the Media indicating the recording yet and if timer T13 (end of RTP Media) is not running,
 - a. SHALL send the MBCP Media Burst Request message toward the PoC Server;
 - b. SHALL start timer T11 (Media Burst Request); and,
 - c. SHALL enter the 'N: pending MB_Request' state.
2. otherwise
 - a. SHALL remain in the 'N: has no permission' state.

6.7.4.3 State: 'N: pending MB request'

The 'N: pending MB_Request' state is a transition state and can only be used in 1-1 PoC Session. The NW PoC Box uses this state when the NW PoC Box is waiting for response to an MBCP Media Burst Request message.

This state is optional and only supported if the NW PoC Box supports the PoC Sessions initiated by Inviting PoC Client compliant only to the PoC version 1.0 specification.

In this state the NW PoC Box can receive RTP Media packets or MBCP Media Burst Control messages when Continuous Media is bound to the Media-floor Control Entity.

Timer T11 (Media Burst Request) is running in this state.

In this state the NW PoC Box can receive MSRP SEND requests when Discrete Media is bound to the Media-floor Control Entity.

6.7.4.3.1 Receive MBCP Media Burst Granted message (R: MB_Granted)

Upon receiving an MBCP Media Burst Granted message from the PoC Server, the NW PoC Box:

1. SHALL initiate procedures for sending message(s) e.g. a voice announcement;
2. SHALL stop timer T11 (Media Burst Request); and,
3. SHALL enter the 'N: has permission' state.

6.7.4.3.2 Receive MBCP Media Burst Taken message (R: MB_Taken)

Upon receiving an MBCP Media Burst Taken message from the PoC Server, the NW PoC Box:

1. if the received PoC Session invitation indicated that the Inviting PoC Client is compliant only to the PoC version 1.0 specification and if the NW PoC Box has already sent the Media indicating recording or if the received PoC Session invitation did not indicate that the Inviting PoC Client is compliant only to the PoC version 1.0 specification,
 - a. SHALL store the PoC Address or Nick Name or both if they are included in the message; of the PoC User granted permission to send a Media Burst as described in subclause 8.4 "*Sender Identification in the PoC Box*", if privacy is not requested;
 - b. SHALL store the mapping between the SSRC of the PoC Client granted a permission to send a Media Burst and the PoC Address or Nick Name or both, if they are included in the message; and,
 - c. SHALL store a timestamp containing the date and time the MBCP Media Burst Taken message was received.
2. SHALL stop timer T11 (Media Burst Request);
3. SHALL start the optional timer T13 (end of RTP Media) if Continuous Media is bound to the Media-floor Control Entity; and,
4. SHALL enter the 'N: has no permission' state.

6.7.4.3.3 Receive MBCP Media Burst Deny message (R: MB_Deny)

Upon receiving an MBCP Media Burst Deny message from the PoC Server, the NW PoC Box:

1. SHALL stop timer T11 (Media Burst Request); and,
2. SHALL enter the 'N: has no permission' state.

6.7.4.3.4 T11 (Media Burst request) timer fired

On firing of timer T11 (Media Burst Request), the NW PoC Box:

1. SHALL send an MBCP Media Burst Request message towards the PoC Server.
2. SHALL restart timer T11 (Media Burst Request); and,

3. SHALL remain in the 'N: pending MB_Request' state.

6.7.4.3.5 T11 (Media Burst request) timer fired N times

On the N:th firing of timer T11 (Media Burst Request), the NW PoC Box:

1. SHALL enter the 'N: has no permission' state.

6.7.4.3.6 Receive RTP Media packets (R: Media)

Upon receiving RTP Media packets the NW PoC Box:

1. if the received PoC Session invitation indicated that the Inviting PoC Client is compliant only to the PoC version 1.0 specification and if the NW PoC Box has not sent the Media indicating recording yet
 - a. SHALL discard the Media;
2. otherwise
 - a. SHALL store the Media;
 - b. SHALL associate the PoC Address or Nick Name or both based on the SSRC of the sending PoC Client, with the stored Media if mapping between those exists in NW PoC Box and if privacy is not requested; and,
 - c. SHALL associate with the stored Media the timestamp that was stored when the Media Burst Taken message was received.

NOTE: In the event that the Media Burst Taken message is not received the timestamp associated with the stored Media can be based upon the time that the first RTP Media packet is received.

3. SHALL stop timer T11 (Media Burst Request);
4. SHALL start the timer T13 (end of RTP Media); and,
5. SHALL enter the 'N: has no permission' state.

6.7.4.3.7 Send MBCP Media Burst Release message (S: MB_Release)

Upon receiving an indication to release permission to send Media, the NW PoC Box:

1. SHALL send an MBCP Media Burst Release message towards the PoC Server.

The MBCP Media Burst Release message:

- a. SHALL set the sequence number ignore field to 1, because no RTP Media packets were sent.
2. SHALL start timer T10 (Media Burst Release); and,
 3. SHALL enter the 'N: pending MB_Release' state.

6.7.4.3.8 Receiving a MSRP SEND request (R: MSRP SEND)

Upon receiving MSRP SEND request the NW PoC Box:

1. SHALL generate and send a MSRP 200 "OK" response according to rules and procedures of [OMA-PoC-IM];
2. SHALL store the received content of the MSRP SEND request;
3. SHALL store the PoC Address or Nick Name or both if they are included in the message retrieved from the message/cpim From header in the MSRP SEND body as described in subclause 8.4 "*Sender Identification in the PoC Box*" and associate with the content of the MSRP SEND request if privacy is not requested;

4. SHALL associate with the stored content of the MSRP SEND request the timestamp that was stored when the Media Burst Taken message was received;

NOTE: In the event that the Media Burst Taken message is not received the timestamp associated with the stored Media can be based upon the time that the first MSRP SEND request is received.

5. SHALL stop timer T11 (Media Burst Request); and,
6. SHALL enter the 'N: has no permission' state.

6.7.4.4 State: 'N: has permission'

The 'N: has permission' state is a stable state and the NW PoC Box uses this state when the NW PoC Box is permitted to send Media.

This state is optional and only supported if the NW PoC Box supports the PoC Sessions initiated by Inviting PoC Client compliant only to the PoC version 1.0 specification.

In this state the NW PoC Box is allowed to send RTP Media packets if Continuous Media is bound to the Media-floor Control Entity and can receive MBCP Media Burst Control messages.

6.7.4.4.1 Send RTP Media packets (S: Media)

NOTE: This subclause applies when the NW PoC Box is sending Media indicating NW PoC Box recording.

When sending encoded Media, the NW PoC Box:

1. SHALL create and send an RTP Media packet toward the PoC Server.

The RTP Media packet SHALL include:

- a. The SSRC of the NW PoC Box; and,
 - b. Other Media packets and payload attributes as defined in subclause 7.2 "*Media Parameter negotiation*".
2. SHALL remain in the 'N: has permission' state.

6.7.4.4.2 Send MBCP Media Burst Release message (S: MB_Release)

Upon receiving an indication to release the permission to send Media, the NW PoC Box:

1. SHALL send an MBCP Media Burst Release message towards the PoC Server.

The MBCP Media Burst Release message:

- a. SHALL include the sequence number of the last RTP Media packet that was sent, if at least 1 RTP Media packet was sent and if Continuous Media is bound to the Media-floor Control Entity; or,
 - b. SHALL set the sequence number ignore field to 1 if only Discrete Media is bound to the Media-floor Control Entity.
2. SHALL start timer T10 (Media Burst Release); and,
 3. SHALL enter the 'N: pending MB_Release' state.

6.7.4.4.3 Receive MBCP Media Burst Revoke message (R: MB_Revoke)

Upon receiving an MBCP Media Burst Revoke message from the PoC Server, the NW PoC Box:

1. SHALL stop sending Media;

NOTE: Media can be buffered in transport layer, in which case it's sending can be impossible to stop.

2. SHALL start the timer T12 (PoC Client retry-after), if a retry after time is contained in the MBCP Media Burst Revoke message;
3. If the reason code is 'Media Burst too long' or 'Media Burst pre-empted' or "Media-floor occupied too long", the NW PoC Box SHALL enter the 'N: pending MB_Revoke' state;
4. If the reason code is 'Only one PoC User' or 'No permission to send a Media Burst', the NW PoC Box:
 - a. SHOULD discard any remaining buffered Media; and,
5. SHALL perform the action in 6.7.4.6.5 "*Send MBCP Media Burst Release message (S: MB_Release)*".

6.7.4.5 State: 'N: pending MB Release'

The 'N: pending MB_Release' state is a transition state and the NW PoC Box uses this state when the NW PoC Box is waiting for response to an MBCP Media Burst Release message.

This state is optional and only supported if the NW PoC Box supports the PoC Sessions initiated by Inviting PoC Client compliant only to the PoC version 1.0 specification.

In this state the NW PoC Box can receive MBCP Media Burst Control messages and RTP Media packets if Continuous Media is bound to the Media-floor Control Entity and MSRP SEND requests if Discrete Media is bound to the Media-floor Control Entity.

Timer T10 (Media Burst release) is running and the optional timer T12 (NW PoC Box retry-after) can be running in this state.

6.7.4.5.1 T10 (Media Burst release) timer fired

On firing of timer T10 (Media Burst Release), the NW PoC Box:

1. SHALL send an MBCP Media Burst Release message towards the PoC Server.

The MBCP Media Burst Release message:

- a. SHALL include the SSRC of the NW PoC Box;
 - b. SHALL include the sequence number of the last RTP Media packet that was sent, if at least 1 RTP Media packet was sent;
 - c. SHALL set the sequence number ignore field to 1 no RTP Media packet was sent and if Continuous Media is bound to the Media-floor Control Entity; and
 - d. SHALL set the sequence number ignore field to 1 if only Discrete Media is bound to the Media-floor Control Entity.
2. SHALL restart timer T10 (Media Burst Release); and,
 3. SHALL remain in state 'N: pending MB_Release'.

6.7.4.5.2 T10 (Media Burst release) timer fired N times

On the N:th firing of timer T10 (Media Burst Release), the NW PoC Box:

1. SHALL enter the 'N: has no permission' state.

6.7.4.5.3 Receive MBCP Media Burst Idle (R: MB_Idle)

Upon receiving an MBCP Media Burst Idle message the NW PoC Box:

1. SHALL stop the timer T12 (PoC Client retry-after) if it is running;
2. SHALL stop timer T10 (Media Burst Release);
3. if the received PoC Session invitation indicates that the Inviting PoC Client is compliant only to the PoC version 1.0 specification and if the NW PoC Box has not finished sending the Media indicating the recording yet,
 - a. SHALL send the MBCP Media Burst Request message toward the PoC Server;
 - b. SHALL start timer T11 (Media Burst Request); and,
 - c. SHALL enter the 'N: pending MB_Request' state.
4. otherwise
 - a. SHALL enter the 'N: has no permission' state.

6.7.4.5.4 Receive MBCP Media Burst Taken message (R: MB_Taken)

Upon receiving an MBCP Media Burst Taken message the NW PoC Box:

1. SHALL send an MBCP Media Burst Acknowledgement message if the MBCP Media Burst Taken indicates an acknowledgement reply;
2. if the received PoC Session invitation indicated that the Inviting PoC Client is compliant only to the PoC version 1.0 specification and if the NW PoC Box has already sent the Media indicating recording or if the received PoC Session invitation did not indicate that the Inviting PoC Client is compliant only to the PoC version 1.0 specification,
 - a. SHALL store the PoC Address or Nick Name or both if they are included in the message; of the PoC User granted permission to send a Media Burst as described in subclause 8.4 "*Sender Identification in the PoC Box*", if privacy is not requested;
 - b. SHALL store the mapping between the SSRC of the PoC Client granted a permission to send a Media Burst and the PoC Address or Nick Name or both, if they are included in the message; and,
 - c. SHALL store a timestamp containing the date and time the MBCP Media Burst Taken message was received.
3. SHALL start the timer T13 (end of RTP Media) if Continuous Media is bound to the Media-floor Control Entity;
4. SHALL stop the timer T12 (PoC Client retry-after) if it is running;
5. SHALL stop timer T10 (Media Burst Release); and,
6. SHALL enter the 'N: has no permission' state.

6.7.4.5.5 Receive RTP Media packets (R: Media)

Upon receiving RTP Media packets the NW PoC Box:

1. If the received PoC Session invitation indicated that the Inviting PoC Client is compliant only to the PoC version 1.0 specification and if the NW PoC Box has not sent the Media indicating recording yet,
 - a. SHALL discard the Media;
2. otherwise
 - a. SHALL store the Media;
 - b. SHALL associate the PoC Address or Nick Name or both based on SSRC of the sending PoC Client, with the stored Media if mapping between those exists in NW PoC Box and if privacy is not requested; and,

- c. SHALL associate with the stored Media the timestamp that was stored when the Media Burst Taken message was received.

NOTE: In the event that the Media Burst Taken message is not received the timestamp associated with the stored Media can be based upon the time that the first RTP Media packet is received.

3. SHALL start the timer T13 (end of RTP Media);
4. SHALL stop timer T10 (Media Burst Release); and,
5. SHALL enter the 'N: has no permission' state.

6.7.4.5.6 Receive MBCP Media Burst Revoke message (R: MB_Revoke)

Upon receiving an MBCP Media Burst Revoke message from the PoC Server, the NW PoC Box:

1. SHALL start the timer T12 (PoC Client retry-after), if a retry after time is contained in the MBCP Media Burst Revoke message; and,
2. SHALL remain in the 'N: pending MB_Release' state.

6.7.4.5.7 Receiving a MSRP SEND request (R: MSRP SEND)

Upon receiving MSRP SEND request the NW PoC Box:

1. SHALL generate and send a MSRP 200 "OK" response according to rules and procedures of [OMA-PoC-IM];
2. SHALL store the received content of the MSRP SEND request;
3. SHALL store the PoC Address or Nick Name or both if they are included in the message retrieved from the message/cpim From header in the MSRP SEND body as described in subclause 8.4 "*Sender Identification in the PoC Box*" and associate with the content of the MSRP SEND request if privacy is not requested;
4. SHALL associate with the stored content of the MSRP SEND request the timestamp that was stored when the Media Burst Taken message was received;

NOTE: In the event that the Media Burst Taken message is not received the timestamp associated with the stored Media can be based upon the time that the first MSRP SEND request is received.

5. SHALL stop timer T11 (Media Burst Request); and,
6. SHALL enter the 'N: has no permission' state.

6.7.4.6 State: 'N: pending MB_Revoke'

The 'N: pending MB_Revoke' state is a transition state and the NW PoC Box uses this state when the NW PoC Box has received an MBCP Media Burst Revoke message and is waiting for any remaining buffered Media to be sent.

This state is optional and only supported if the NW PoC Box supports the PoC Sessions initiated by Inviting PoC Client compliant only to the PoC version 1.0 specification.

In this state the NW PoC Box is sending Media and can receive MBCP Media Burst Control messages.

6.7.4.6.1 Send RTP Media (S: Media)

NOTE: This subclause applies when the NW PoC Box is sending Media indicating NW PoC Box recording.

If the NW PoC Box has encoded Media remaining in the buffer, the NW PoC Box:

1. SHOULD create and send an RTP Media packet toward the PoC Server.

The RTP Media packet SHALL include:

- a. The SSRC of the PoC Client; and,
 - b. Other Media and payload attributes as defined in subclause 7.2 "*Media Parameter negotiation*".
2. If the sent RTP Media packet has not been the last packet from the NW PoC Box's buffer, the NW PoC Box SHALL remain in the 'N: pending MB_Revoke' state.
 3. If the sent RTP Media packet has been the last packet from the NW PoC Box's buffer, the NW PoC Box SHALL perform the action in 6.7.4.6.5 "*Send MBCP Media Burst Release message*".

6.7.4.6.2 Receive MBCP Media Burst Idle message (R: MB_Idle)

Upon receiving an MBCP Media Burst Idle message the NW PoC Box:

1. SHALL stop sending Media;
2. if the received PoC Session invitation indicates that the Inviting PoC Client is compliant only to the PoC version 1.0 specification, if the NW PoC Box has not finished sending the Media indicating the recording yet and if timer T12 (PoC Client retry-after) is not running,
 - a. SHALL send the MBCP Media Burst Request message toward the PoC Server;
 - b. SHALL start timer T11 (Media Burst Request); and,
 - c. SHALL enter the 'N: pending MB_Request' state.
3. otherwise
 - a. SHALL enter the 'N: has no permission' state.

6.7.4.6.3 Receive MBCP Media Burst Taken message (R: MB_Taken)

Upon receiving an MBCP Media Burst Taken message the NW PoC Box:

1. SHALL stop sending Media;
2. if the received PoC Session invitation indicated that the Inviting PoC Client is compliant only to the PoC version 1.0 specification and if the NW PoC Box has already sent the Media indicating recording or if the received PoC Session invitation did not indicate that the Inviting PoC Client is compliant only to the PoC version 1.0 specification,
 - a. SHALL store the PoC Address or Nick Name or both if they are included in the message; of the PoC User granted permission to send a Media Burst, as described in subclause 8.4 "*Sender Identification in the PoC Box*" if privacy is not requested;
 - b. SHALL store the mapping between the SSRC of the PoC Client granted a permission to send a Media Burst and the PoC Address or Nick Name or both, if they are included in the message; and,
 - c. SHALL store a timestamp containing the date and time the MBCP Media Burst Taken message was received.
3. SHALL start the optional timer T13 (end of RTP Media) if Continuous Media is bound to the Media-floor Control Entity; and,
4. SHALL enter the 'N: has no permission' state.

6.7.4.6.4 Receive RTP Media packets (R: Media)

Upon receiving RTP Media packets the NW PoC Box:

1. SHALL stop sending Media;
2. if the received PoC Session invitation indicated that the Inviting PoC Client is compliant only to the PoC version 1.0 specification and if the NW PoC Box has not sent the Media indicating recording yet,
 - a. SHALL discard the Media.
3. otherwise
 - a. SHALL store the received Media;
 - b. SHALL associate the PoC Address or Nick Name or both based on SSRC of the sending PoC Client, with the stored Media if mapping between those exists in NW PoC Box and if privacy is not requested; and,
 - c. SHALL associate with the stored Media the timestamp that was stored when the Media Burst Taken message was received.

NOTE: In the event that the Media Burst Taken message is not received the timestamp associated with the stored Media can be based upon the time that the first RTP Media packet is received.

4. SHALL start the timer T13 (end of RTP Media); and,
5. SHALL enter the 'N: has no permission' state.

6.7.4.6.5 Send MBCP Media Burst Release message (S: MB_Release)

The NW PoC Box:

1. SHALL send an MBCP Media Burst Release message towards the PoC Server.

The MBCP Media Burst Release message:

- a. SHALL include the SSRC of the NW PoC Box;
 - b. SHALL include the sequence number of the last RTP Media packet that was sent if Continuous Media is bound to the Media-floor Control Entity; and,
 - c. SHALL set the sequence number ignore field to 1 if only Discrete Media is bound to the Media-floor Control Entity.
2. SHALL start timer T10 (Media Burst Release); and,
 3. SHALL enter the 'N: pending MB_Release' state.

6.7.4.6.6 Receiving a MSRP SEND request (R: MSRP SEND)

Upon receiving MSRP SEND request the NW PoC Box:

1. SHALL generate and send a MSRP 200 "OK" response according to rules and procedures of [OMA-PoC-IM];
2. SHALL store the received content of the MSRP SEND request;
3. SHALL store the PoC Address or Nick Name or both if they are included in the message retrieved from the message/cpim From header in the MSRP SEND body as described in subclause 8.4 "*Sender Identification in the PoC Box*" and associate with the content of the MSRP SEND request if privacy is not requested;
4. SHALL associate with the stored content of the MSRP SEND request the timestamp that was stored when the Media Burst Taken message was received;

NOTE: In the event that the Media Burst Taken message is not received the timestamp associated with the stored Media can be based upon the time that the first MSRP SEND request is received.

5. SHALL stop timer T11 (Media Burst Request); and,
6. SHALL
 - a. enter the 'N: has no permission' state if the MSRP SEND request has been the last chunk of the MSRP message; or,
 - b. remain in the 'N: pending MB_Revoke' state, if the MSRP SEND request has not been the last chunk of the MSRP message.

6.7.4.7 Any state

This subclause describes the events in all states except the events in the 'Start-stop' state. The subclause 6.7.4.1 "*State 'Start-stop'*" describes the events in the 'Start-stop' state.

6.7.4.7.1 Receive PoC Session release – 1 (R: PoC Session release - 1)

Upon receiving a PoC Session release stage 1 request from the Control Plane when the PoC Session is released or when the Media-floor Control Entity is terminated as specified in [OMA-PoC-CP] "*NW PoC Box specific procedures*", the NW PoC Box:

1. SHALL stop sending MBCP messages and Media packets towards the PoC Server; and,
2. SHALL enter the 'Releasing' state.

6.7.4.8 State: 'Releasing'

The 'Releasing' state is a transition state. The NW PoC Box uses this state while waiting for Control Plane to finalize the disconnection of a PoC Session.

6.7.4.8.1 Receive PoC Session release – 2 (R: PoC Session release - 2)

Upon receiving a PoC Session release stage 2 request from the Control Plane, the NW PoC Box:

1. SHALL release all resources including any running timers associated with the PoC Session; and,
2. SHALL enter the 'Start-stop' state and terminate the PoC Session control state machine.

6.7.5 NW PoC Box procedures for Media Stream not bound to Media-floor Control Entity

NOTE: The Discrete Media can also be recorded by the [OMA-PoC-CP] "*NW PoC Box receiving a SIP MESSAGE request*" if received in the SIP MESSAGE request.

6.7.5.1.1 Receiving a MSRP SEND request

Upon receiving an MSRP SEND request in the Media Stream not bound to a Media-floor Control Entity, the NW PoC Box:

1. SHALL generate and send a MSRP 200 "OK" response according to rules and procedures of [OMA-PoC-IM];
2. SHALL store the received content of the MSRP SEND request;
5. SHALL store the PoC Address or Nick Name or both if they are included in the message retrieved from the message/cpim From header in the MSRP SEND body as described in subclause 8.4 "*Sender Identification in the PoC Box*"; and,
3. SHALL store a timestamp containing the date and time the MSRP SEND request message was received.

NOTE: The sending of reports related to Discrete Media is described in subclauses 7.12 "*Discrete Media Transfer Final Report*" and 7.13 "*Discrete Media Transfer Progress Report*".

7. Media control

7.1 Quality feed back

7.1.1 General

The PoC Client, the PoC Server performing the Controlling PoC Function and the PoC Box MAY send quality feedback reports for the Continuous Media packet transmission. If the PoC Client supports sending multiple synchronized Continuous Media, the PoC Client SHALL send the quality feedback reports for the Continuous Media packet transmission.

The quality feedback SHALL be done according to rules and procedures of [RFC3550] with the clarifications in this subclause. If supported, the quality feedback reporting:

- SHALL be performed by the transmission of RTCP Receiver Reports (RR) packets and Sender Reports (SR) packets; and,
- SHALL send the SR packets and the RR packets as RTCP SR compound packets and RTCP RR compound packets.

7.1.2 Procedures at the PoC Client

The PoC Client:

- SHALL act as an RTP endpoint according to [RFC3550];
- MAY support the transmission of RTCP SR/RR compound packets; and,

NOTE 1: Some PoC Clients can utilize radio bearers that prohibit the possibility to collect sender and reception statistics. Such PoC Client doesn't have to send any RTCP SR/RR compound packets, e.g. Service Option 60, see [3GPP2 C.S0047-0].

- SHALL support the reception of RTCP SR/RR compound packets.

The PoC Client when sending PoC Speech not synchronized with other Continuous Media:

- SHOULD NOT schedule transmission of RTCP SR compound packets during a Media Burst (to reduce potential degradation of the quality of the RTP Media packet transmission); and,
- SHOULD NOT schedule the transmission of RTCP RR compound packets during a Media Burst (to save bandwidth).

NOTE 2: Periodic transmission of RTCP RR compound packets during RTP Media packet transfer can be used as 'heart beat' indication from the receiving PoC Clients to the PoC Server. One of the functions RTCP SR compound packets perform is synchronize multiple data streams, e.g. Audio and Video, and if synchronization is performed the transmission of RTCP SR compound packets during the RTP Media packet transfer is required.

The PoC Client sending multiple Continuous Media that are synchronized:

- SHALL send a RTCP SR compound packet and RTCP RR compound packet according to rules and procedures of [RFC3550].

NOTE 3: If the PoC Client sends multiple Continuous Media that are synchronized, the PoC Client needs to send the RTCP SR compound packet as soon as possible after being granted permission to send Media in order to allow the receiving PoC Client to synchronize the Media Bursts.

The PoC Client MAY apply the PoC Speech specific rules and procedures of this subclause to other Continuous Media, when not synchronized.

7.1.2.1 PoC Client sending RTP Media packets

A PoC Client that supports quality feedback and has sent RTP Media packets of PoC Speech:

- SHALL send a RTCP SR compound packet, when it ends the Media Burst by sending the MBCP Media Burst Release message.

The PoC Client MAY apply the PoC Speech specific rules and procedures of this subclause to other Continuous Media, when not synchronized.

7.1.2.2 PoC Client receiving RTP Media packets

A PoC Client that supports quality feedback and has received RTP Media packets of PoC Speech:

- SHALL send a RTCP RR compound packet, when it gets an indication to trigger the transmission of the RTCP RR compound packet; and,

NOTE 1: Which indication the PoC Client uses to trigger the transmission of the RTCP RR compound packet is an implementation option but it can be the reception of a RTCP SR compound packet, an indication that the Media Burst has ended, i.e. the reception of a MBCP Media Burst Idle message or the expiry of the 'PoC Client end of RTP Media timer'.

- SHOULD use the reception of the RTCP SR compound packet as an indication to trigger the transmission of the RTCP RR compound packet.

NOTE 2: Quality feedback is an implementation option and a PoC Client cannot rely on the other PoC Clients in the PoC Session to send RTCP SR compound packets. Therefore, a PoC Client that waits for a RTCP SR compound packet before sending a RTCP RR compound packet must have a fallback option.

A PoC Client using the reception of the RTCP SR compound packet of PoC Speech as indication to trigger the transmission of the RTCP RR compound packet:

- SHOULD implement a timer that supervises the reception of the RTCP SR compound packet.

NOTE 3: This timer should be started when the PoC Client gets an indication that the Media Burst has ended. On expiry of the timer the PoC Client should conclude that the RTCP SR compound packet is not sent or is lost. On expiry the PoC Client should send the RTCP RR compound packet to the PoC Server even though it hasn't received the RTCP SR compound packet.

NOTE 4: Specification of this timer is outside the scope of this specification.

The PoC Client MAY apply the PoC Speech specific rules and procedures of this subclause to other Continuous Media, when not synchronized.

7.1.3 Procedures at the PoC Server performing the Participating PoC Function

The PoC Server performing the Participating PoC Function:

- SHALL be a 'translator' according to [RFC3550] for the RTP/RTCP flows;
- SHALL forward all RTCP compound packets from the PoC Client(s) to the PoC Server performing the Controlling PoC Function;

- SHALL forward all RTCP compound packets from the PoC Server performing the Controlling PoC Function to the PoC Client(s);
- SHALL modify the content of the RTCP compound packets if it is required by the translation, e.g. due to repacketizing;
- MAY modify the content of the RTCP SR compound packet send by the PoC Client in an interrupted PoC Session to reflect that the PoC Server has discarded RTP Media packets (if the ongoing Media Burst in a PoC Session was interrupted due to a Media Burst from the another PoC Session); and,
- SHALL forward RTCP SR compound packets only to those PoC Clients that received any RTP Media packets of the previously sent Media Burst in the PoC Session or which are receiving RTP Media packets of the currently sent Media Burst in the PoC Session.

NOTE: The previous bullet does not apply in case the PoC Client did not receive the Media Burst due to receiving or sending RTP Media packets in another PoC Session (in a Simultaneous PoC Session case).

7.1.4 Procedures at the PoC Server performing the Controlling PoC Function

The PoC Server performing the Controlling PoC Function:

- SHALL be a 'translator' according to [RFC3550] for the RTP/RTCP flows;
- SHALL forward (and in a PoC Group communication, multiply) the RTCP SR compound packet sent from the PoC Client that transmitted the most recent Media Burst or from the PoC Client that has permission to send Media to all other PoC Clients in the PoC Session;
- SHALL modify the content of the RTCP SR compound packets if it is required by the translation, e.g. due to repacketizing;
- SHALL NOT forward RTCP RR compound packets sent from a PoC Client to all other PoC Clients in the PoC Session;
- MAY be implemented as a 'monitor' according to [RFC3550] for the RTP flow and use the reported statistics to estimate the current quality of service for fault diagnosis, User Plane adaptation and charging purposes;
- MAY generate and send a RTCP RR compound packet for the Media Burst that it recently received from a PoC Client; and,

NOTE 1: [RFC3550] states that a translator can require an SSRC identifier of its own for the purpose of sending reception reports about what it has received. These would be multicast to all PoC Clients in the Session.

- SHALL forward RTCP SR compound packets only to those PoC Clients that received any RTP Media packets of the previously sent Media Burst in a PoC Session or which are receiving RTP Media packets of the currently sent Media Burst in the PoC Session.

NOTE 2: The previous bullet does not apply for the PoC Client which put the RTP Media packets component on hold.

7.1.5 Procedures at the PoC Box

7.1.5.1 Procedures at the NW PoC Box

The PoC Box:

- SHALL act as an RTP endpoint according to [RFC3550];
- MAY support the transmission of RTCP SR/RR compound packets;

- SHALL support the reception of RTCP SR/RR compound packets;
- SHOULD NOT schedule transmission of RTCP SR compound packets during a Media Burst (to reduce potential degradation of the quality of the RTP Media packet transmission); and,
- SHOULD NOT schedule the transmission of RTCP RR compound packets during a Media Burst (to save bandwidth).

NOTE: Periodic transmission of RTCP RR compound packets during RTP Media packet transfer can be used as 'heart beat' indication from the receiving NW PoC Box to the PoC Server. One of the functions RTCP SR compound packets perform is synchronize multiple data streams, e.g. Audio and Video, and if synchronization is performed the transmission of RTCP SR compound packets during the RTP Media packet transfer is required.

7.1.5.2 Procedures at the UE PoC Box

The PoC Box:

- SHALL act as an RTP endpoint according to [RFC3550];
- MAY support the transmission of RTCP SR/RR compound packets;
- SHALL support the reception of RTCP SR/RR compound packets; and,
- SHOULD NOT schedule the transmission of RTCP RR compound packets during a Media Burst (to save bandwidth).

NOTE: Periodic transmission of RTCP RR compound packets during RTP Media packet transfer can be used as 'heart beat' indication from the receiving UE PoC Box to the PoC Server.

7.2 Media Parameter negotiation

This subclause contains additional information to the Media Parameter negotiation specified in [OMA-PoC-CP].

PoC Speech Media Parameters in addition to the codec(s) are:

- reference to the Media-floor Control Entity to which the PoC Speech is bound;
- codec modes which are indicated in the preferred order as specified in [RFC 3264], [RFC3267] and [RFC3558];
- bandwidth parameter used to indicate the maximum desired data rate supported by the PoC Client for the PoC Session as specified in [RFC3264]; and,
- ptime and maxptime parameters as specified in [RFC4566], [RFC3267] and [RFC 3558].

The Media Parameters of the Continuous Media apart from PoC Speech in addition to the codec(s) are

- reference to the Media-floor Control Entity to which the Continuous Media is bound;
- band width parameter used to indicate the maximum desired data rate supported by the PoC Client for the PoC Session as specified in [RFC3264];
- ptime and maxptime parameters as specified in [RFC4566], [RFC3267] and [RFC 3558]; and,
- other Media Parameters defined for the codecs used for the Continuous Media.

The Media Parameters of the Discrete Media are

- optional reference to the Media-floor Control Entity to which the Discrete Media is bound; and,

- the Media Parameters as defined in [OMA-IM-TS] and endorsed in [OMA-PoC-IM].

7.3 User Plane adaptation

User Plane adaptation is a re-negotiation of the Media Parameters during a PoC Session. The initiation of the User Plane adaptation is optional for the PoC Client, NW PoC Box, UE PoC Box and the PoC Server performing the Controlling PoC Function.

User Plane adaptation can be triggered e.g. by roaming or when a new PoC Client with lower Media Parameters enters the PoC Session.

During the PoC Session the voice frame packetization or voice codec mode by out-band signalling can be changed.

When a new PoC Client enters a PoC Group Session the new PoC Client sends a SIP message as specified in [OMA-PoC-CP] "*PoC Client procedures*" with SDP payload that indicates the initial Media Parameters of the PoC Client to the PoC Server performing the Controlling PoC Function.

7.3.1 Procedures at the PoC Client

The PoC Client SHALL re-negotiate the Media Parameters, if initiated by the PoC Server, as specified in [OMA-PoC-CP] "*PoC Client receiving a request for User Plane adaptation*".

The PoC Client MAY initiate the User Plane adaptation (out-band) as specified in [OMA-PoC-CP] "*User Plane adaptation*" triggered by e.g. roaming to the system with different Media Parameters.

7.3.2 Procedures at the PoC Server performing the Participating PoC Function

The PoC Server SHALL support the Media Parameter re-negotiation, when initiated by the PoC Server performing the Controlling PoC Function or the PoC Client and SHALL forward the SIP/SDP payloads between the PoC Server performing the Controlling PoC Function and the PoC Client as specified in [OMA-PoC-CP] "*Participating PoC Function procedures*".

7.3.3 Procedures at the PoC Server performing the Controlling PoC Function

The PoC Server SHALL re-negotiate the Media Parameters, when initiated by the PoC Client (out-band).

The PoC Server MAY initiate the User Plane adaptation (Media Parameter re-negotiation during a PoC Session) when a new PoC Client with lower Media Parameters enters or leaves the PoC Session.

When determining the Media Parameters the PoC Server SHOULD take into account the highest common Media Parameters provided by both the new and the existing Participants in the PoC Session (i.e. the negotiation procedure can make all Participants of the PoC Session adapted to the common highest denominator in terms of bandwidth usage).

In the case that the Media Parameters of the new Participant force the PoC Server to update all other PoC Session Participants, the PoC Server SHALL update the Media Parameters in the Control Plane as specified in [OMA-PoC-CP] "*Controlling PoC Function Procedures*" to all other PoC Clients in the PoC Session.

7.3.4 Procedures at the PoC Box

The NW PoC Box SHALL re-negotiate the Media Parameters, as specified in [OMA-PoC-CP] "*NW PoC Box receiving a request for User Plane adaptation*" if initiated by the PoC Server.

The UE PoC Box SHALL re-negotiate the Media Parameters, as specified in [OMA-PoC-CP] "*UE PoC Box receiving a request for User Plane adaptation*" if initiated by the PoC Server ".

NOTE: The UE PoC Box or the NW PoC Box never initiates User Plane adaptation.

7.4 Media on and off hold

7.4.1 Procedures at the PoC Client

The PoC Client MAY place the Media on hold as specified in [OMA-PoC-CP] "*PoC Client placing Media on hold*".

When Media is on hold the Media Bursts are not transferred to the PoC Client, but the PoC Client SHALL be able to receive MBCP messages when on hold.

The PoC Client MAY send Media Bursts, when the Media is on hold.

The PoC Client MAY place the Media off hold as specified in [OMA-PoC-CP] "*PoC Client placing Media off hold*".

When Media is placed off hold the PoC Client SHALL be able to send and receive Media Bursts and send and receive MBCP messages.

7.4.2 Procedures at the PoC Server performing the Participating PoC Function

The PoC Server SHOULD forward the Media Bursts and MBCP messages between the PoC Client and the PoC Server performing the Controlling PoC Function.

7.4.3 Procedures at the PoC Server performing the Controlling PoC Function

When the Media Stream is put on hold by a PoC Client or when the Media Stream is set to unidirectional Media transfer for PoC Media Traffic Optimisation purposes, the PoC Server:

- SHALL NOT transfer Media to the PoC Client;
- SHALL NOT buffer Media for the PoC Client, but SHALL discard it;
- SHALL send MBCP messages to the PoC Client;
- MAY send RTCP SR/RR messages to the PoC Client;
- SHALL be able to receive Media and MBCP messages from the PoC Client;
- SHALL send Discrete Media reports to the PoC Client, if requested; and,
- SHALL abort ongoing Discrete Media transfer to the PoC Client and report error, if requested.

When Media Stream is placed off hold and the PoC Client's Media Stream is not set to unidirectional transmission for PoC Media Traffic Optimisation purposes, the PoC Server:

- SHALL resume Media transfer to the PoC Client; and,
- SHALL NOT include the PoC Client in the ongoing Discrete Media Transfer.

7.4.4 Procedures at the PoC Box

Placing Media on Hold is not defined for the NW PoC Box or the UE PoC Box.

7.5 Simultaneous PoC Sessions

7.5.1 Procedures at the PoC Client

If the PoC Client supports Simultaneous PoC Sessions the following SHALL apply:

- The PoC Client SHALL be able to receive the RTP Media packets of any Simultaneous PoC Sessions sent by the PoC Server.
- The PoC Client SHALL be able to receive the MBCP messages of any of the Simultaneous PoC Sessions sent by the PoC Server.
- The received MBCP messages SHOULD be indicated to the PoC User.
- PoC Client SHOULD be able to send RTP Media packets to any of the Simultaneous PoC Sessions according to the PoC User selection.

When the PoC Client participates in Simultaneous PoC Sessions and there are Continuous Media packets transferred in several PoC Sessions, the PoC Client SHALL expect the PoC Session it receives the RTP Media packets from, is selected by the Participating PoC Function according to principles described in the subclause 7.5.2 "*Procedures at the PoC Server performing the Participating PoC Function*". When changing reception from one PoC Session to another the PoC Client SHALL release the Media Burst if requested, granted or queued.

7.5.2 Procedures at the PoC Server performing the Participating PoC Function

If the PoC Server supports Simultaneous PoC Sessions the following SHALL apply:

The PoC Server SHALL send Continuous Media packets to the PoC Box independent of the procedures described in this subclause.

When there are Continuous Media packets in more than one PoC Session in which the PoC Client is a Participant at the same time, the Participating PoC Function of the Home PoC Server SHALL filter the Media Bursts so that the PoC User hears a single Conversation.

For each PoC Session the PoC Server performing the Participating PoC Function SHALL either send all Continuous Media Streams (i.e. PoC Speech, Audio, Video) to the PoC Client or discard all Continuous Media Streams according to principles, in the order presented below:

1. select the PoC Session where the PoC Client has the permission to send Media.
2. select the PoC Session where the PoC User is locked.
3. select the Primary PoC Session if RTP Media packets are received.
4. select the PoC Session where the PoC Client has transmitted within the inactivity period (in order to maintain a Conversation).
5. select the PoC Session which starts first.
6. select among the on-going PoC Sessions according to the PoC Server local policy.

When started to forward Media Bursts of one PoC Session to the PoC Client the PoC Server SHALL continue forwarding Media Bursts of this same PoC Session until any of the following happens:

- PoC Session is released;
- PoC Session is put on hold;
- Higher priority PoC Session is activated;
- User locks himself to another PoC Session;
- The PoC Client is granted the permission to send Media in another PoC Session; or,

- Conversation timer expires (see the "Conversation timer (T14)" in subclause 9.2 "*Timers in the PoC Server performing the Participating PoC Function*").

The PoC Server SHOULD forward the MBCP messages of all PoC Sessions from the PoC Server(s) performing the Controlling PoC Function to PoC Client.

The PoC Server MAY send a RTCP SR message to the PoC Client concerning the PoC Session, which was interrupted due to activity in another PoC Session. The PoC Server MAY modify the RTCP RR and SR messages sent between the PoC Client and the PoC Server performing Controlling PoC Function to improve the accuracy of the quality feedback in the case of interrupted Media Burst.

In the case of changing from one PoC Session to another and starting to transfer RTP Media packets during an on-going Media Burst the PoC Server MAY send a MBCP Media Burst Taken message prior to the first RTP Media packet being sent to the PoC Client.

NOTE: Media filtering is not affected to Discrete Media.

7.5.3 Procedures at the PoC Server performing the Controlling PoC Function

There are no related Simultaneous PoC Session procedures in the PoC Server performing the Controlling PoC Function.

7.5.4 Procedures at the PoC Box

Simultaneous PoC Sessions does not apply for the NW PoC Box or the UE PoC Box.

7.6 RTP Session release of the Pre-established Session

RTP Session release on the User Plane is made either by PoC Server sending the MBCP Disconnect message to the PoC Client as specified in subclauses 6.2.6 "*PoC Session control state diagram – Pre-established Session*" and 6.3.6 "*Pre-established Session state diagram –basic*" or by the PoC Client sending the SIP REFER request to the PoC Server as specified in the [OMA-PoC-CP] "*Leaving a PoC Session – Pre-established case*".

7.7 Media transfer

7.7.1 Procedures at the PoC Client

The PoC Client SHALL transfer RTP Media packets according to rules and procedures specified in [RFC3550].

7.7.2 Procedures at the PoC Server performing the Participating PoC Function

The PoC Server performing the Participating PoC Function SHALL transfer RTP Media according to rules and procedures specified in [RFC3550].

In case of Simultaneous PoC Sessions the PoC Server SHALL discard RTP Media of the PoC Sessions not selected for transmitting to the PoC Client.

The PoC Server MAY determine a risk of congestion exists. How the PoC Server determines the risk of congestion is out of the scope of this specification.

The PoC Server MAY discard RTP Media packets from or to PoC Users based on the Local QoE Profile assigned to the PoC User, if the PoC Server has determined that risk of congestion exists.

7.7.3 Procedures at the PoC Server performing the Controlling PoC Function

The PoC Server performing the Controlling PoC Function SHALL transfer RTP Media packets according to rules and procedures specified in [RFC3550].

The PoC Server MAY also buffer the RTP Media packets as specified in the subclause 7.8. "Media buffering".

The PoC Server MAY determine that a risk of congestion exists. How the PoC Server determines the risk of congestion is out of the scope of this specification.

The PoC Server MAY discard RTP Media packets of PoC Sessions based on the QoE Profile of the PoC Session, if the PoC Server has determined that a risk of congestion exists. If RTP Media packets of the PoC Session are discarded due to risk of congestion, the PoC Server MAY either perform the actions specified in subclause 6.4.4.3.9 "Congestion exists" or MAY release the PoC Session as specified in [OMA-PoC-CP].

The PoC Server performing the Controlling PoC Function SHOULD send the RTP Media packets with the bit rate not higher than the maximum bit rate indicated by the PoC Client as described in [OMA-PoC-CP].

7.7.4 Procedures at the NW PoC Box

If the NW PoC Box supports sending RTP Media and support compatibility with PoC 1.0 PoC Clients the NW PoC Box SHALL transfer RTP Media packets according to rules and procedures of [RFC3550].

7.7.5 Procedures at the UE PoC Box

Not applicable.

7.8 Media buffering

7.8.1 Procedures at the PoC Client

The PoC Client SHOULD cope with the variable latency in the incoming RTP Media packets to achieve acceptable QoS. The PoC Client MAY indicate limitations in its receive Media buffering capabilities by indicating its maximum received bit rate for any specific Media, as described in [OMA-PoC-CP] "Talk Burst Control Protocol MIME registrations".

The PoC Client MAY buffer Media before receiving a MBCP Media Burst Granted message.

The PoC Client MAY buffer Media before or after receiving a SIP 200 "OK" response.

If the PoC Client buffers Media prior to receiving a SIP 200 "OK" response the PoC Client SHALL continue to buffer Media after receiving a SIP 200 "OK" response. When a MBCP Media Burst Granted message is received, the PoC Client SHALL send the buffered Media as RTP Media packets and continue buffering Media until all buffered Media has been sent.

If the PoC Client supports Limited Segment Media Buffer Preload and receives in the SIP 200 "OK" response the SDP parameter `tb_seg_preload` the PoC Client SHALL send an amount of Media limited by the value of the SDP parameter `tb_seg_preload`, see [OMA-PoC-CP] and then SHALL continue buffering the Media. When a MBCP Media Burst Granted message is received, the PoC Client SHALL send the buffered Media as RTP Media packets and continue buffering Media until all buffered Media has been sent.

7.8.2 Procedures at the PoC Server performing the Participating PoC Function

Not applicable.

7.8.3 Procedures at the PoC Server performing the Controlling PoC Function

The PoC Server MAY support Media buffering.

If the PoC Server supports Media buffering and sends Media Burst granted to the originating PoC Client after it has received an Unconfirmed Indication for one or more terminating PoC Clients or if the PoC Server supports Limited Segment Media Buffer Preload, the PoC Server SHALL support Media buffering until at least one PoC Client has responded accepting the invitation. There SHALL only be one buffer for a PoC Session and when the PoC Server begins to forward the RTP Media packets to the PoC Clients, it SHALL discard the RTP Media packets after they have been forwarded. The buffer details including the buffer depth are out of scope of this specification. When transmitting buffered RTP Media packets, the PoC Server SHOULD transmit the packets at a bit rate that avoids overloading the receiving PoC Client(s). If PoC Client has indicated its receive Media buffering capabilities as specified in [OMA-PoC-CP], the PoC Server performing the Controlling PoC Function SHOULD send the RTP Media packets with a bit rate not higher than the maximum bit rate indicated by the PoC Client.

NOTE 1: The PoC Server can initiate User Plane adaptation procedure (e.g. codec negotiation) with the PoC Client in order to meet the maximum bit rate indicated by the PoC Client.

If the PoC Server supports allowing the PoC Client to buffer Media the PoC Server MAY allow the PoC Client to continue to buffer Media after sending the SIP 200 "OK" unconfirmed response by delaying sending the MBCP Media Burst Granted message up until at least one PoC Client has responded accepting the invitation.

If the PoC Server supports Limited Segment Media Buffer Preload and the PoC Client has indicated support for Limited Segment Media Buffer Preload using the `tb_seg_preload` parameter in the SDP the PoC Server MAY indicate to the PoC Client to send a limited segment of the buffered Media using the `tb_seg_preload` parameter in the SDP of the SIP 200 "OK" response see [OMA-PoC-CP] "*Controlling PoC Function procedures*".

NOTE 2: In the case of manual answer, the PoC Server begins sending RTP Media packets when the first PoC Client answers and does not retain those RTP Media packets for PoC Clients that answer later.

7.8.4 Procedures at the PoC Box

Not applicable.

7.9 Codecs

3GPP2 mandates the EVRC speech codec as the default speech codec for PoC see [3GPP2 S.R0100-0]. Therefore, the PoC Server and the NW PoC Box SHALL support the usage of EVRC specific Media Parameters.

The Media Parameters and the RTP payload format for the EVRC speech codec are described in [RFC3558].

3GPP mandates the AMR narrowband speech codec as the default speech codec for PoC see [TS26.235]. Further, 3GPP mandates support of the AMR wideband speech codec, if the terminal on which the PoC Client is implemented uses 16 kHz sampling frequency of the speech see [TS26.235]. Therefore, the PoC Server and the NW PoC Box SHALL support the usage of both AMR narrowband and AMR wideband specific Media Parameters.

The Media Parameters for the AMR narrowband speech codec and the AMR wideband speech codec are described together with the RTP payload format for the speech codecs in [RFC3267]. The AMR and AMR-WB RTP payload format offers a number of options that can be used for the RTP Media packet transport. The options that should be used in PoC are specified in [TS26.236], with the exception of the explicit requirement in Appendix D "*RTP Session description parameters*".

NOTE: In addition to the 3GPP and 3GPP2 recommended codec, PoC Clients, UE PoC Box and NW PoC Box and PoC Servers can support other codecs. Transcoding support by the PoC Server is beyond the scope of PoC specification.

7.10 PoC Media Traffic Optimisation

PoC Media Traffic Optimisation is a mechanism for reducing PoC Media traffic via the PoC-4 reference point. The usage of PoC Media Traffic Optimisation is optional for both the PoC Server performing the Controlling PoC Function and the PoC Server performing the Participating PoC Function.

The PoC Server performing the Controlling PoC Function and the PoC Server performing the Participating PoC Function MAY negotiate unidirectional Media Stream transmission for PoC Media Traffic Optimisation purposes. The PoC Server performing the Participating PoC Function MAY forward Media Streams from the PoC Server performing the Controlling PoC Function to PoC Clients or PoC Boxes with unidirectional Media Stream transmission and Media Stream set off hold.

The PoC Server performing the Participating PoC Function MAY re-negotiate directions of Media Stream transmissions for PoC Media Traffic Optimisation purposes when PoC Clients or PoC Boxes served by the PoC Server performing the Participating PoC Function leave the PoC Session or when PoC Clients set their Media Stream on hold.

NOTE: The PoC Media Traffic Optimisation cannot be negotiated for PoC Session, in which the 1-many-1 communication method is used.

7.11 Media Burst Control Schemes

During a PoC Session establishment, the PoC Server performing Controlling PoC Function MAY apply specific Media Burst Control Scheme in the PoC Session. These Media Burst Control Schemes provide some policy how the PoC Server grants Media Burst permissions to Participants.

Indication of Media Burst Control Scheme is negotiated in the Control Plane as describing in [OMA-PoC-CP] "*Talk Burst Control Protocol MIME registration*".

7.12 Discrete Media Transfer Final Report

7.12.1 General

The PoC Client, NW PoC Box and UE PoC Box that supports Discrete Media using MSRP and the PoC Server SHALL support the Discrete Media Transfer Final Report functionality.

The Discrete Media Transfer Final Report is not recommended for Discrete Media of small size e.g. chat with text/plain or files of small size.

The PoC Client MAY request Discrete Media Transfer Final Report functionality from the PoC Server performing the Controlling PoC Function when sending Discrete Media using MSRP. If the PoC User wishes to know whether Discrete Media has been delivered to recipient(s) successfully or not, the PoC Client SHALL request for the Discrete Media Transfer Final Report from the PoC Server performing the Controlling PoC Function.

For the Final-Report functionality this specification defines:

1. A new namespace for the definition of new headers in message/cpim bodies to request Discrete Media Transfer Final Report. This namespace is identified by the URN <urn:oma:xml:poc:final-report>;
2. A new header field in message/cpim body. The name of this header is 'Final-Report' and belongs to the above mentioned namespace. According to the procedures of [RFC 3862], the header field is prefixed by a prefix that is linked to the mentioned namespace. The 'Final-Report' header field can have a value of 'yes' or 'no'; and,
3. A new MIME body of type "application/vnd.oma.poc.final-report" to identify a Discrete Media Transfer Final Report XML document that carries the Discrete Media Transfer Final Report information.

7.12.2 Procedures at the originating PoC Client

When the PoC Client requests for the Discrete Media Transfer Final Report, the PoC Client creates an MSRP SEND request that contains a message/cpim body according to [RFC3862].

The PoC Client:

1. SHALL include an NS header in the message/cpim body that links a prefix of the PoC Client chose with the well known URN of <urn:oma:xml:poc:final-report>;

NOTE 1: Although the PoC Client is able to choose any prefix of its choice, it is recommended to use a meaningful prefix, such as 'FR'.

2. SHALL include a 'Final-Report' header in the message/cpim body, prefixed with earlier defined prefix. The value of the 'Final-Report' header SHALL be set to 'yes'; and,
3. MAY include in the MSRP SEND request a Success-Report header and a Failure-Report header set to value 'yes'.

Upon receiving the MSRP SEND or MSRP REPORT request containing the MIME body of type "application/vnd.oma.poc.final-report+xml", the PoC Client:

1. SHOULD extract the delivery status(es) of Participant(s) from the body; and,
2. MAY render the information about delivery status to the PoC User.

NOTE 2: The PoC Client can receive more than one Discrete Media Transfer Final Report depending on the PoC Server aggregation of the Discrete Media Transfer Final Reports. In this case, in the Discrete Media Transfer Final Report there can be the final delivery status of one or more PoC Client(s), but not the status of all receiving PoC Clients.

NOTE 3: The correlation of the messages sent and the Discrete Media Transfer Final Reports received are performed with the Message-ID. It is PoC Client implementation issue how long PoC Client maintains the Message-ID stored.

Upon receiving a MSRP non 2xx response for the MSRP SEND request requesting the Final Report, the PoC Client:

1. MAY render the failure information to the PoC User.

7.12.3 Procedures at the PoC Server performing the Controlling PoC Function

The PoC Server performing the Controlling PoC Function MAY be requested to provide the Discrete Media Transfer Final Report about the delivery of Discrete Media.

If Discrete Media Transfer Final Report is requested, the PoC Server performing the Controlling PoC Function:

1. SHALL include in MSRP SEND request a Success-Report header and Failure-Report header with value set to 'yes'; and,
2. SHALL send the MSRP SEND request to the terminating PoC Client(s) according to rules and procedures of [RFC4975].

When receiving MSRP REPORT requests or an MSRP non 2xx response from the terminating PoC Clients, the PoC Server:

1. SHALL cache the received delivery status information with information received from the other PoC Client(s) receiving the Discrete Media.

When composing the Discrete Media Transfer Final Report, the PoC Server:

1. SHALL compose the Discrete Media Transfer Final Report XML document that contains the delivery information of one or more Participants.

NOTE 1: The PoC Server can either send multiple Discrete Media Transfer Final Reports containing the delivery status of one or more Participants or it can send one Discrete Media Transfer Final Report at the end, containing the delivery statuses of all Participants.

When sending the Discrete Media Transfer Final Report to the originating PoC Client, the PoC Server:

1. SHALL in case the PoC Client requested MSRP REPORTs,

- a. generate a MSRP REPORT request according to rules and procedures of [RFC4975];
- b. add an MSRP Content-Type header field set to the value "application/vnd.oma.poc.final-report+xml";
- c. include a Discrete Media Transfer Final Report XML document as previously indicated; and,
- d. send the MSRP REPORT request to the originating PoC Client according to rules and procedures of [RFC4975].

or,

2. SHALL, in case the originating PoC Client did not request MSRP REPORT,
 - a. generate an MSRP SEND request according to rules and procedures of [RFC4975];
 - b. add an MSRP Content-Type header field set to the value "application/vnd.oma.poc.final-report+xml";
 - c. include a Discrete Media Transfer Final Report XML document as previously indicated; and,
 - d. send the MSRP REPORT request to the originating PoC Client according to rules and procedures of [RFC4975].

When the PoC Server performing the Controlling PoC Function has been requested a Discrete Media Transfer Final Report, the PoC Server SHALL send one or more Discrete Media Transfer Final Report(s) in a way that the final delivery status of each Participant is reported. If the PoC Server sends multiple Discrete Media Transfer Final Reports, the PoC Server SHALL indicate the delivery status of each Participant in one Discrete Media Transfer Final Report only.

NOTE 2: A received MSRP SEND request containing the MIME type "application/vnd.oma.poc.final-report+xml" body is transparently distributed to other Participants according to the normal Controlling PoC Function procedures.

7.12.4 Procedures at the PoC Server performing the Participating PoC Function

The PoC Server performing the Participating PoC Function SHALL transparently pass the MSRP SEND requests, the MSRP SEND responses and MSRP REPORT requests, if applicable.

7.12.5 Procedures at the terminating PoC Client

Upon receiving a MSRP SEND request and if a MSRP REPORT have been requested and if receiving Discrete Media using MSRP is supported the PoC Client:

1. SHALL generate and send the MSRP REPORT requests according to rules and procedures of [RFC4975].

NOTE: The terminating PoC Client can respond with 413 MSRP response if the terminating PoC Client wishes the PoC Server performing the Controlling PoC Function to stop sending the particular message for any reason.

7.12.6 Procedures at the terminating PoC Box

Upon receiving a MSRP SEND request and if a MSRP REPORT have been requested and if receiving Discrete Media using MSRP the UE PoC Box or the NW PoC Box:

1. SHALL generate and send the MSRP REPORT requests according to rules and procedures of [RFC4975].

NOTE: The terminating NW PoC Box or the UE PoC Box can respond with 413 MSRP response if the terminating NW PoC Box wishes the PoC Server performing the Controlling PoC Function to stop sending the particular message for any reason.

7.13 Discrete Media Transfer Progress Report

7.13.1 General

The PoC Client that sends Discrete Media using MSRP MAY request Discrete Media Transfer Progress Reports from the PoC Server performing the Controlling PoC Function while initiating the Discrete Media transfer using MSRP, when the Discrete Media Transfer Progress Reports have been negotiated as specified in [OMA-PoC-CP]. The PoC Server SHALL support detailed Discrete Media Transfer Progress Report and MAY support optimized Discrete Media Transfer Progress Report. The PoC Client MAY support the Discrete Media Transfer Progress Reports.

For the Discrete Media Transfer Progress Report functionality this specification defines:

1. A new namespace for the definition of new headers in message/cpim bodies to request Discrete Media Transfer Progress Report. This namespace is identified by the URN <urn:oma:xml:poc:det-progress-rep> and <urn:oma:xml:poc:opt-progress-rep>.
2. Two new header fields in message/cpim body. The names of these headers are 'Detailed-Progress-Report' and 'Optimized-Progress-Report' and they belong to the above mentioned namespace. According to the procedures of [RFC 3862], the header field is prefixed by a prefix that is linked to the mentioned namespace. The 'Detailed-Progress-Report' and 'Optimized-Progress-Report' header fields can have a value of 'yes' or 'no'.
3. Two new MIME bodies of type "application/vnd.oma.poc.detailed-progress-report+xml" and "application/vnd.oma.poc.optimized-progress-report+xml" to identify the XML document that carries the Discrete Media Transfer Progress Report information.

7.13.2 Procedures at the originating PoC Client

When PoC Client sending the Discrete Media over MSRP requests the Discrete Media Transfer Progress Report from the PoC Server performing the Controlling PoC Function, the PoC Client:

1. SHALL set the Success-Report header of MSRP SEND requests to value 'yes';
2. SHALL set the Failure-Report header of MSRP SEND request to value 'yes';
3. SHALL include in MSRP SEND request an NS header in the message/cpim body that links a prefix of the PoC Client chose with the well known URN of <urn:oma:xml:poc:det-progress-rep> or <urn:oma:xml:poc:opt-progress-rep>;

NOTE: Although the PoC Client is able to choose any prefix of its choice, it is recommended to use a meaningful prefix, such as 'PR'.

4. SHALL include either 'Detailed-Progress-Report' header in the message/cpim body or 'Optimized-Progress-Report' header in the message/cpim body, prefixed with earlier defined prefix. The value of the 'Detailed-Progress-Report' or 'Optimized-Progress-Report' header SHALL be set to 'yes'.
5. SHALL send the MSRP SEND request according to rules and procedures of [RFC4975].

If PoC Server has indicated support for detailed or optimized Discrete Media Transfer Progress Report as specified in [OMA-PoC-CP] and if PoC Client has requested either a detailed Discrete Media Transfer Progress Report or an optimized Discrete Media Transfer Progress Report from the PoC Server performing the Controlling PoC Function, the PoC Client on reception of MSRP REPORT request:

1. SHOULD extract the delivery progress information from the MIME body "application/vnd.oma.poc.detailed-progress-report+xml" or "application/vnd.oma.poc.optimized-progress-report+xml" contained in the MSRP REPORT request, if contained;
2. MAY render the delivery progress information to the PoC User; and,
3. MAY render the failure information to the PoC User.

7.13.3 Procedures at the terminating PoC Client

Upon receiving the Discrete Media using MSRP transport and if a MSRP REPORT have been requested and if Discrete Media is supported, the PoC Client:

1. SHALL generate the REPORT request according to rules and procedures of [RFC4975] if Success-Report is set to "yes" in the received MSRP SEND request with a chunk, complete message of which has not been received yet.

NOTE: The terminating PoC Client can respond with 413 MSRP response if the terminating PoC Client wishes the PoC Server performing the Controlling PoC Function to stop sending the particular message for any reason.

7.13.4 Procedures at the terminating PoC Box

Upon receiving the Discrete Media using MSRP transport and if a MSRP REPORT have been requested and if Discrete Media is supported, the UE PoC Box or the NW PoC Box:

1. SHALL generate the MSRP REPORT request according to rules and procedures of [MSERP] if Success-Report is set to "yes" in the received MSRP SEND request with a chunk, complete message of which has not been received yet; and,
2. SHALL send the MSRP REPORT request according to rules and procedures of [RFC4975].

NOTE: The terminating PoC Box can respond with 413 MSRP response if the terminating PoC Box wishes the PoC Server performing the Controlling PoC Function to stop sending the particular message for any reason.

7.13.5 Procedures at the PoC Server performing the Controlling PoC Function

If Discrete Media Transfer Progress Report has been requested by the originating PoC Client, the PoC Server performing the Controlling PoC Function SHALL provide the Discrete Media Transfer Progress Reports.

The PoC Server performing the Controlling PoC Function SHALL consider the Discrete Media Transfer Progress Report been requested if

1. the cpim/message in the MSRP SEND request contains a new namespace definition header "NS" pointing to <urn:oma.xml:poc:det-progress-rep> or <urn:oma.xml:poc:opt-progress-rep>;
2. the cpim/message in the MSRP SEND request contains either header 'Detailed-Progress-Report' or 'Optimized-Progress-Report' prefixed with earlier defined prefix set to value 'yes';
3. MSRP SEND requests contains Success-Report header with value 'yes'; and,
4. MSRP SEND requests contains Failure-Report header with value 'yes'.

If Discrete Media Transfer Progress Report has been requested, the PoC Server when sending the Discrete Media towards terminating PoC Clients:

1. SHALL set the Success-Report header of MSRP SEND requests to value 'yes'; and,
2. SHALL set the Failure-Report header of MSRP SEND requests to value 'yes'.

When PoC Server performing the Controlling PoC Function receives MSRP REPORT requests or a MSRP non-2xx response from the terminating PoC Client(s), the PoC Server:

1. SHALL cache the information on delivery progress from the MSRP REPORT request or the MSRP non-2xx response;
2. if the PoC Server determines that the Discrete Media Transfer Progress Report is to be sent,
 - a. SHALL generate an MSRP REPORT request according to rules and procedures of [RFC4975];

- b. SHALL compose the detailed Discrete Media Transfer Progress Report indicating the delivery progress status of all or subset of the Participants, whose delivery progress status has changed since the last detailed Discrete Media Transfer Progress Report, in the MIME body "application/vnd.oma.poc.detailed-progress-report+xml", if the detailed Discrete Media Transfer Progress Report is requested;
- c. SHALL compose the optimized Discrete Media Transfer Progress Report indicating the delivery progress status of the Participants, if delivery progress status has changed since the last optimized Discrete Media Transfer Progress Report, in the MIME body "application/vnd.oma.poc.optimized-progress-report+xml", if optimized Discrete Media Transfer Progress Report is requested and supported;
- d. SHALL include MIME body in the MSRP REPORT request; and,
- e. SHALL send the MSRP REPORT request according to rules and procedures of [RFC4975] to the originating PoC Client.

The PoC Server performing Controlling PoC Function:

1. SHALL send the Discrete Media Transfer Progress Report if complete message delivery status is already known for all the Participants;
2. SHOULD send the Discrete Media Transfer Progress Report if complete message delivery status became known for a Participant; and,
3. MAY send the Discrete Media Transfer Progress Report according to PoC Server local policy when a Participant's delivery status has changed since the previous Discrete Media Transfer Progress Report.

7.13.6 Procedures at the PoC Server performing the Participating PoC Function

The Discrete Media Transfer Progress Report does not require any additional support from the PoC Server performing the Participating PoC Function above the MSRP request and response relaying.

8. Sender Identification

This subclause describes the procedures to provide Sender Identification.

Sender Identification is the process of conveying the PoC Address or Anonymous PoC Address and the Nick Name from the PoC Server performing the Controlling PoC Function to the PoC Client or the PoC Box.

8.1 Sender Identification information in the PoC Server performing the Controlling PoC Function

The PoC Server SHALL collect and cache for each Participant the following:

1. the PoC Address of the Participant as specified in [OMA-PoC-CP] "*Authenticated Originator's PoC Address*";
2. the Anonymous PoC Address as specified in [OMA-PoC-CP] "*Anonymous PoC Address*", if the Participant requested privacy;
3. the Nick Name of the Participant as specified in [OMA-PoC-CP] "*Nick Name*", if the Nick Names are supported by the PoC Server;
4. whether the privacy was requested by the Participant;
5. whether the PoC Server performing the Participating PoC Function of the Participant stays on the Media path and acts as a back to back UA determined by receiving the URI parameter as specified in [OMA-PoC-CP] "*Back to back UA uri-parameter*"; and,
6. the SSRC identifier(s) of the RTP stream(s) used by the PoC Client of the Participant.

The SSRC identifier becomes known to the PoC Server when:

1. RTP Media packet is received from the PoC Client;
2. MBCP packet or TBCP packet is received from the PoC Client; or,
3. RTCP compound packet is received from the PoC Client.

The PoC Server SHALL include the PoC Address and Nick Name of the Participant who has been permitted to send a Media Burst in the MBCP Media Burst Taken message, if privacy is not requested and even if privacy is requested and the PoC Server performing Participating PoC Function has indicated to stay on the Media path.

The PoC Server SHALL include the Anonymous PoC Address and Nick Name of the Participant who has been permitted to send a Media Burst in the MBCP Media Burst Taken message, if the PoC Server performing Participating PoC Function has not indicated to stay on the Media path and if privacy is requested.

The PoC Server SHALL preserve the SSRC identifier, of the PoC Client sending the Media Burst, in the RTP Media packets sent to the PoC Clients that are receiving the Media Burst. This allows the receiving PoC Clients to use the SSRC identifier to identify the Participant sending the Media Burst in the case when the MBCP Media Burst Taken message is lost.

The PoC Server SHALL set the PoC Address or the Anonymous PoC Address and the Nick Name of the Participant in the outgoing MSRP SEND requests as specified in [OMA-POC-IM].

8.2 Sender Identification information in the PoC Client

For Continuous Media the PoC Client:

1. SHALL receive the PoC Address or Anonymous PoC Address and MAY receive the Nick Name of the Participant that has been permitted to send a Media Burst in the MBCP Media Burst Taken message and the PoC Client MAY display this information to the PoC User;

2. MAY collect information about the other Participants, their identities and the SSRC identifiers used by their PoC Clients in the PoC Session in order to be able to map a RTP Media packet in case the MBCP Media Burst Taken message is lost; and,
3. SHOULD keep itself updated with the information provided by the PoC Server performing the Controlling PoC Function if the PoC Client collects information about the other Participants.

NOTE: The PoC Client can for instance store the latest mapping between the Participants PoC Address or Anonymous PoC Address, the Nick Name and SSRC identifier.

For Discrete Media the PoC Client:

1. SHALL include the PoC Address or Anonymous PoC Address and MAY include the Nick Name in the MSRP SEND request as specified in [OMA-PoC-IM]; and,
2. SHALL receive the PoC Address or Anonymous PoC Address and MAY receive the Nick Name of the Participant that who has been permitted to send the Discrete Media in the MSRP SEND request as specified in [OMA-PoC-IM] unless privacy is requested.

8.3 Sender Identification information in the PoC Server performing the Participating PoC Function

This subclause describes the procedure for the PoC Server to deliver the information about Sender Identification to the receiving PoC Clients in case PoC Server performing Participating PoC Function stays on the Media path.

The PoC Server SHALL replace the PoC Address and Nick Name of the Participant who has been permitted to send a Media Burst in the MBCP Media Burst Taken message by an anonymous identity, if privacy is indicated in the MBCP Media Burst Taken message. The PoC Server SHOULD use the unique anonymous identity received in the Anonymous identity field, if included in the received MBCP Media Burst Taken message.

The PoC Server SHALL forward the PoC Address of the Participant who has been permitted to send a Media Burst in the MBCP Media Burst Taken message, if privacy is not indicated in the MBCP Media Burst Taken message.

The PoC Server MAY change the Nick Name of the Participant who has been permitted to send a Media Burst in the MBCP Media Burst Taken message as specified in [OMA-PoC-CP] "*Nick Name*" when used.

The PoC Server SHALL include in the outgoing MSRP SEND request the PoC Address or Anonymous PoC Address and Nick Name of the PoC User at the PoC Client if received in the incoming MSRP SEND request as specified in [OMA-PoC-IM].

8.4 Sender Identification in the PoC Box

This procedure applies to the UE PoC Box and the NW PoC Box.

When receiving Continuous Media the PoC Box:

1. SHALL store the PoC Address received in the MBCP Media Burst Taken message unless privacy is requested; and,
2. SHOULD store the Nick Name received in the MBCP Media Burst Taken message if a Nick Name is available.

When receiving Discrete Media the PoC Box:

1. SHALL store the PoC Address received in the Discrete Media in the MSRP SEND request as specified in [OMA-PoC-IM] unless privacy is requested; and,
2. SHOULD store the Nick Name received in the Discrete Media in the MSRP SEND request as specified in [OMA-PoC-IM] if a Nick Name is available.

9. Timers

9.1 Timers in the PoC Server performing the Controlling PoC Function

Table 15: Media Burst Control timers

TIMER	TIMER VALUE	CAUSE OF START	NORMAL STOP	ON EXPIRY
T1 'End of RTP Media timer'	Configurable Max 6 seconds Default value: 4 Seconds NOTE: The minimum value (Min) should be greater than the expected round trip delay from PoC Server to remote PoC Client. Special consideration should be given to over-the-air connections that introduce significant transmission latency due to low bandwidth. NOTE: The T1 can be set to higher value than normally when the queued PoC Client is granted the permission to send Media.	Transmission of either a SIP message that includes an optional <code>tb_granted</code> parameter, or a MBCP Media Burst Granted message to the PoC Client that are given permission to send a Media Burst. If the MBCP Media Burst Request message is re-transmitted from the PoC Client that has permission to send a Media Burst, a new MBCP Media Burst Granted message is sent to the PoC Client, then T1 is reset and started again. T1 restarts again every time a RTP packet from the PoC Client that has permission to send a Media Burst reaches the PoC Server performing the Controlling PoC Function.	The reception of the last RTP packet in a Media Burst and then a MBCP Media Burst Release message. NOTE: If the MBCP Media Burst Release message doesn't include the sequence number of the last RTP packet the T1 is stopped on the reception of the MBCP Media Burst Release message.	When T1 expires it is concluded that the Media Burst, which it was started for, has been completed.
T2 'Stop talking timer'	Configurable May be different for different PoC Users and thus dependent on subscription. Default value: 30 seconds.	Detection of the start of a Media Burst.	Detection of the completion of a Media Burst.	When T2 expires it is concluded that the PoC Client that has permission to send a Media Burst has talked too long.
T3 'Stop talking grace timer'	Configurable Dependent on T8 Default value: $T3 = T8 \times \text{'allowed number of retransmissions of the MBCP Media Burst Revoke message'}$. T3 shall only permit an allowed number of retransmissions of the MBCP Media Burst Revoke message. The value range for the counter is configurable between 1 ... 10. Default value: 3.	Expiry of T2.	Reception of a MBCP Media Burst Release message and the last RTP packet in a Media Burst from the PoC Client that has permission to send a Media Burst. NOTE: If the MBCP Media Burst Release message doesn't include the sequence number of the last RTP packet the T3 is stopped on the reception of the MBCP Media Burst Release message.	When T3 expires, the PoC Client that talked too long is penalized and put in a waiting state in which it cannot be granted the right to speak.
T4 'Inactivity timer'	Configurable May be different for different type of PoC Sessions. Default value: 30 seconds.	The current Media Bursts end and the PoC Server performing the Controlling PoC Function enters the 'G: MB_Idle' state.	A PoC Client requests the right to speak.	The PoC Session is released.

<p>T7 'Media Burst Idle timer'</p>	<p>Configurable Should use exponential back off mechanism Default value: The Fibonacci number series $F_1 = 1, F_2 = 1, F_{n+2} = F_n + F_{n+1}, 1 \leq n \leq 11$ This means that the time interval between the MBCP Media Burst Idle messages will be: 1, 1, 2, 3, 5, 8, 13, 21, 34, 55, 89 seconds. If the PoC Session still is running after the time series above has passed, it is recommended that MBCP Media Burst Idle message be transmitted every 89 second until the PoC Server performing the Controlling PoC Function detects a Media Burst request or start of a Media Burst.</p>	<p>The transmission of a MBCP Media Burst Idle message to the PoC Clients in the PoC Session.</p>	<p>Detection of start of a Media Burst. T7 is also stopped when the 'inactivity timer' expires.</p>	<p>When T7 expires the PoC Server performing the Controlling PoC Function sends another MBCP Media Burst Idle message to the PoC Clients.</p>
<p>T8 'Media Burst Revoke timer'</p>	<p>Configurable. Default value: 1 second.</p>	<p>A MBCP Media Burst Revoke message is sent to a PoC Client.</p>	<p>Expiry of T3 or reception of a MBCP Media Burst Release message from the PoC Client the MBCP Media Burst Revoke message was sent to.</p>	<p>Send another MBCP Media Burst Revoke message to the PoC Client and reset and start T8 again.</p>
<p>T9 'Retry-after timer'</p>	<p>Configurable. 5-30 seconds. Default value: 5 seconds.</p>	<p>The PoC Server performing the Controlling PoC Function enters the 'U: waiting MB_Revoke' state when either T3 expires or it receives a MBCP Media Burst Release message from the revoked PoC Client.</p>		<p>When T9 expires the PoC Server performing the Controlling PoC Function permits the PoC Client to have permission to send a Media Burst if the PoC Client sends a MBCP Media Burst Request message.</p>
<p>T18 'end of Media-floor time timer'</p>	<p>Configurable This is a system defined value.</p>	<p>When a PoC Client is granted permission to occupy the Media-floor.</p>	<p>When receiving a MBCP Release message from the granted PoC Client.</p>	<p>When T18 expires a MBCP Media Burst Revoke message is sent.</p>
<p>T19 'start of MSRP timer'</p>	<p>Configurable Max 6 seconds Default value: 4 seconds NOTE: The minimum value should be greater than the expected round trip delay from PoC Server to remote PoC Client. Special consideration should be given to over-the-air connections that introduce significant transmission latency due to low bandwidth. NOTE: The T19 can be set to higher value than normally when the queued PoC Client is granted the permission to send Media.</p>	<p>When a PoC Client is granted permission to occupy the Media-floor.</p>	<p>T19 is stopped when the first MSRP SEND request is received or when a MBCP Media Burst Release message is received.</p>	<p>When T19 expires it is concluded that the Media Burst, which it was started for, has been completed.</p>

T20 'Granted re-send'	Configurable. Default value: 1 second T20 shall only permit a certain number of retransmissions of the MBCP Media Burst Granted message. The total time during which the PoC Server retransmits MBCP Media Burst Granted messages is limited by lower of T1 and T19.	When the PoC Server grants the permission to send the Media to a PoC Client, which was queued and which negotiated "queuing". T20 is also started again when the PoC Server sends a MBCP Media Burst Granted message upon T20 firing.	The reception of a RTP Media packet, MSRP SEND request and loosing the permission to send Media.	When T20 expires, a new MBCP Media Burst Granted message is sent.
-----------------------	---	--	--	---

9.2 Timers in the PoC Server performing the Participating PoC Function

Table 16: Simultaneous PoC Session timers

TIMER	TIMER VALUE	CAUSE OF START	NORMAL STOP	ON EXPIRY
T14 'Conversation timer'	Configurable. 3-10 Seconds. May be different for different type of PoC Sessions. Default value: 5 seconds.	Reception of the MBCP Media Burst Release message from the PoC Client or a MBCP Media Burst Idle message from the PoC Server performing the Controlling PoC Function.	Reception of another Media Burst in the same PoC Session.	When T14 expires is concluded that the Conversation in the PoC Session has completed and PoC Server is allowed to reselect the RTP Media packet stream for forwarding to the PoC Client.

Table 17: Media Burst Control timers

TIMER	TIMER VALUE	CAUSE OF START	NORMAL STOP	ON EXPIRY
T15 'Connect message re-transmit timer'	Up to implementation T15 only permits a certain number of retransmissions of the MBCP Connect messages. The total time during which the PoC Server retransmits MBCP Connect messages shall be less than 6 seconds.	The PoC Server sends a MBCP Connect message that expect a MBCP Media Burst Acknowledgement message reply.	The reception of a MBCP Media Burst Acknowledgment message.	Repeat the sending of the MBCP Connect message to PoC Client.
T16 'Disconnect message re-transmit timer'	Up to implementation. T16 only permits a certain number of retransmissions of the MBCP Disconnect messages. The total time during which the PoC Server retransmits MBCP Disconnect messages shall be less than 6 seconds.	The PoC Server sends a MBCP Disconnect message.	The reception of a MBCP Media Burst Acknowledgement message.	When T16 expires, a new MBCP Disconnect message is sent.

9.3 Timers in the PoC Client

Table 18: Media Burst Control timers

TIMER	TIMER VALUE	CAUSE OF START	NORMAL STOP	ON EXPIRY
T10 'Media Burst Release timer'	Configurable as specified in [OMA-PoC-CP] "OMA PoC Device Management general". T10 shall only permit a certain number of retransmissions of the MBCP Media Burst Release message. The total time during which the PoC Client retransmits MBCP Media Burst Release messages shall be less than 6 seconds.	The PoC Client sends a MBCP Media Burst Release message.	The reception of a MBCP Media Burst Idle message or when the PoC Client detects the start of a Media Burst.	When T10 expires, a new MBCP Media Burst Release message is sent.
T11 'Media Burst Request timer'	Configurable as specified in [OMA-PoC-CP] "OMA PoC Device Management general". T11 shall only permit a certain number of retransmissions of the MBCP Media Burst Request message. The total time during which the PoC Client retransmits MBCP Media Burst Request messages should be less than 6 seconds.	The PoC Client initiates the PoC Session and sends a SIP message that serves as an implicit MBCP Media Burst Request message. T11 is also started when the PoC Client sends a MBCP Media Burst Request message.	The reception of a MBCP Media Burst Granted message, a MBCP Media Burst Taken message, a MBCP Media Burst Deny message, MBCP Media Burst Request Queue Status message or when the PoC Client detects the start of a Media Burst from another PoC Client.	When T11 expires, a new MBCP Media Burst Request message is sent.
T12 'PoC Client retry-after timer'	Delivered by PoC Server as specified in subclause 6.2.5.4.3 "Receive MBCP Media Burst Revoke message (R: MB_Revoke)". Dependent on T9 since the value should be as specified in the retry-after field of the received MBCP Media Burst Revoke message.	The PoC Server performing the Controlling PoC Function enters the 'U: waiting MB_Revoke' state and the possibility for the PoC Client to send a MBCP Media Burst Request message is disabled.	Reception of a MBCP Media Burst Idle message or a MBCP Media Burst Taken message.	When T12 expires the PoC Client enables the possibility to send a MBCP Media Burst Request message.
T13 'PoC Client end of RTP Media timer'	Configurable as specified in [OMA-PoC-CP] "OMA PoC Device Management general". Should be equal to T1.	Reception of a MBCP Media Burst Taken message or an RTP packet. T13 is reset and started again every time a RTP packet is received.	The reception of a MBCP Media Burst Idle message.	When T13 expires the PoC Client concludes that the Media Burst, which it was started for, has completed.
T17 'Revocation Alert timer'	Calculated from the Copy of the value of T2 and the Alert Margin, both delivered by PoC Server within MBCP Media Burst Granted message as specified in subclause 6.5.3 "MBCP Media Burst Granted message". The initial value of T17 equals T2 minus Alert-Margin.	When receiving the Media Burst Granted message containing the Alert-Margin parameter.	Detection of the completion of a Media Burst.	When T17 expires the PoC Client makes an Advanced Revocation Alert. NOTE: When the value of Alert Margin is '0' and T17 expires, MBCP Media Burst Release message or MBCP Media Burst Release message can be sent to the PoC Server.
T21 'Limited Media Segment Timer'	Configurable as specified in [OMA-PoC-CP] "OMA PoC Device Management general".	Entering state 'U: Permission to send limited segment'.	The reception of a MBCP Media Burst Grant message.	When T21 expires the PoC Client resends a MBCP Media Burst Request message and restarts the T21 timer.

9.4 Timers in the PoC Box

The NW PoC Box and the UE PoC Box SHALL use the timers defined for the PoC Client in the subclause 9.3 "*Timers in the PoC Client*" as specified in subclause 6.7 "*Procedures at the PoC NW Box*" and 6.6 "*Procedures at the PoC UE Box*".

Appendix A. Change History (Informative)

A.1 Approved Version History

Reference	Date	Description
n/a	n/a	No prior version

A.2 Draft/Candidate Version 2.0 History

Document Identifier	Date	Sections	Description
Draft Versions: OMA-TS-PoC_UserPlane-V2_0	11 Nov 2006	All	The initial version of this document.
	17 Feb 2006	Document front page, 6.2.5.4.3, 6.2.5.6.1, 6.2.5.6.5	Took the OMA-TS-PoC_UserPlane-V1_0-20060127-C as baseline and updated according to: Updated with agreed CR: OMA-POC-PoC2-2006-0043R01
	19 May 2006	Document front page, 6.2.5.4.3, 6.2.5.6.1, 6.2.5.6.5	Took the OMA-TS-PoC_UserPlane-V1_0-20060609-A as baseline and Updated with agreed CR: OMA-POC-PoC2-2006-0043R01
	22 May 2006	All	Created a version to used for contribution as agreed in the Kansas City meeting. Note that all references to subclauses are now unformatted and not hyperlinked any more.
	19 Jun 2006	Annex X	Updated with agreed CRs: OMA-POC-POCv2-2006-0499 OMA-POC-POCv2-2006-0444R03 OMA-POC-POCv2-2006-0361 OMA-POC-POCv2-2006-0334R03 OMA-POC-POCv2-2006-0537
Draft Versions: OMA-TS-PoC_UserPlane-V2_0	24 Jul 2006	3.2, 3.3, 4.1, 4.2, 5.2, 5.2.1, 5.3, 5.4, 5.5 (new), 6.2.5, 6.2.5.4.4, 6.3.7.2.6, 6.3.7.2.7, 6.3.7.3.3, 6.3.7.3.5, 6.3.8.1.1, 6.3.8.1.2, 6.3.8.2.7, 6.4.5.3.3, 6.5 (almost all subclauses) and editorials in many places.	Updated with agreed CRs: OMA-POC-POCv2-2006-0626 OMA-POC-POCv2-2006-0621R01 OMA-POC-POCv2-2006-0615 OMA-POC-POCv2-2006-0613 OMA-POC-POCv2-2006-0599R03 OMA-POC-POCv2-2006-0591R01 OMA-POC-POCv2-2006-0590R01 OMA-POC-POCv2-2006-0589 OMA-POC-POCv2-2006-0565
	31 Aug 2006	Editorials in many places, 6.2.1, 6.2.3, 2.1, 3.2, 4.1, 6.5.5, 6.4.3.1, 6.4.5.1.1, 6.4.5.3.4, 6.4.5.6.1, 6.4.5.7.3, 6.2.5.1.1, 3.2, 6.3.4, 7.2.2, 7.4.3, 7.4.10 (new), 6.5.1.2, 6.5.1.2.5, 9.3, 6.2.5.3.1, 6.2.5.4.4.	Updated with agreed CRs: OMA-POC-POCv2-2006-0647R01 OMA-POC-POCv2-2006-0745R01 OMA-POC-POCv2-2006-0654 OMA-POC-POCv2-2006-0650 OMA-POC-POCv2-2006-0649 OMA-POC-POCv2-2006-0633R02 OMA-POC-POCv2-2006-0587R03 OMA-PoC-PoCv2-2006-0469R04 OMA-PoC-PoCv2-2006-0636r02
	25 Sep 2006	Editorials in almost all subclauses, 5.4, 8.1, 8.3 (new), 6.5.7, 6.1.2.1, 6.1.2.1.6, 6.4.4.3.1, 6.4.5.1.1, 6.2.5.5, 6.2.5.5.3, 6.2.5.5.4, 6.4.5, 6.4.5.5.5, 6.4.5.5.6, 6.4.5.5.7 and 6.4.5.6.1, 6.4.4.3.7, 6.4.4.2.2, 7.2.2, 7.2.3, 6.3.7.2, 6.3.7.2.8	Updated with agreed CRs: OMA-POC-POCv2-2006-0769 OMA-POC-POCv2-2006-0868R01 OMA-POC-POCv2-2006-0669R02 OMA-POC-POCv2-2006-0852 OMA-POC-POCv2-2006-0851 OMA-PoC-PoCv2-2006-0842r01 OMA-PoC-PoCv2-2006-0841R01 OMA-POC-POCv2-2006-0830 OMA-POC-POCv2-2006-0829

Document Identifier	Date	Sections	Description
		(new), 6.4.4.3.6, 6.4.4.3.7, 6.4.5.4.1, 6.2.10 (new + subclauses), 6.3.1 – 6.3.6, 7.5, 6.5.1.2, 6.3.1, 6.4.1, 6.4.2,6.4.3 and 6.4.3A (new), 6.4.6 (new), A.2.4, A.3.4, 5.6, Appendix E (new), 6.2.5.4, 7.11 (new), 6.5.13, 6.4.4.1.1, 6.4.1.3.7, 6.4.2.1.1 and 6.4.1.1.2.	OMA-POC-POCv2-2006-0828 OMA-POC-POCv2-2006-0827R01 OMA-POC-POCv2-2006-0814R01 OMA-POC-POCv2-2006-0809r04 OMA-POC-POCv2-2006-0799R01 OMA-POC-POCv2-2006-0794R01 OMA-POC-POCv2-2006-0772r1 OMA-POC-POCv2-2006-0770 OMA-POC-POCv2-2006-0755 OMA-POC-POCv2-2006-0744R01 OMA-POC-POCv2-2006-0773r02 OMA-POC-POCv2-2006-0743R01 OMA-POC-POCv2-2006-0796R01 OMA-POC-POCv2-2006-0742R01 OMA-POC-POCv2-2006-0710R04 OMA-POC-POCv2-2006-0709R02 OMA-POC-POCv2-2006-0700R03 OMA-POC-POCv2-2006-0648R02
	24 Oct 2006	(Editorial all, 6.5.13, 3.2, 6.4.4, 6.4.4.2.2, 6.4.4.3.8 (new subclause), 7.7.2, 7.7.3, 6.5.13, 6.6 (New), 6.4.5.2.3, 6.4.4.2.2, 6.2.4A, 6.3.3A, 6.4.3A, 6.4.1, 9.4 (new), 6.4.6, 6.4.6.3.2, 6.7 (new), 5.4, 8, 5.2.1, 7.2, A.13, A.2.4, A.3.4, 1, 6.4.4, B.3.2, B.1.1.2, 6.2.10 (all), 6.2.10.6.3 (new), 4.1, 4.2, 6.1.3.1.6 (new)	OMA-POC-POCv2-2006-0918 OMA-POC-POCv2-2006-1076 OMA-POC-POCv2-2006-1072 OMA-POC-POCv2-2006-1071R01 OMA-POC-POCv2-2006-1064R01 OMA-POC-POCv2-2006-1047R02 OMA-POC-POCv2-2006-1038 OMA-POC-POCv2-2006-1011 OMA-POC-POCv2-2006-0950R01 OMA-POC-POCv2-2006-0948r01 OMA-POC-POCv2-2006-0936r01 OMA-POC-POCv2-2006-0928r01 OMA-POC-POCv2-2006-0927r01 OMA-POC-POCv2-2006-0926r01 OMA-POC-POCv2-2006-0923r01 OMA-POC-POCv2-2006-0922r02 OMA-POC-POCv2-2006-0921r01 OMA-POC-POCv2-2006-0920r01 OMA-POC-POCv2-2006-0919 OMA-POC-POCv2-2006-0917R01 OMA-POC-POCv2-2006-0916r01 OMA-POC-POCv2-2006-0915r01 OMA-POC-POCv2-2006-0715R03
	11 Nov 2006	All	OMA-POC-POCv2-2006-1099 OMA-PoC-PoCv2-2006-0843r01 OMA-POC-POCv2-2006-0961R03 OMA-POC-POCv2-2006-1088 OMA-POC-POCv2-2006-1090R02 OMA-POC-POCv2-2006-1091 OMA-POC-POCv2-2006-1093 OMA-POC-POCv2-2006-1094 OMA-POC-POCv2-2006-1095 OMA-POC-POCv2-2006-1096 OMA-POC-POCv2-2006-1097 OMA-POC-POCv2-2006-1098R01 OMA-POC-POCv2-2006-1100R01 OMA-POC-POCv2-2006-1101r01 OMA-POC-POCv2-2006-1103r01 OMA-POC-POCv2-2006-1104r01

Document Identifier	Date	Sections	Description
			OMA-POC-POCv2-2006-1105 OMA-POC-POCv2-2006-1106 OMA-POC-POCv2-2006-1110 OMA-POC-POCv2-2006-1111 OMA-POC-POCv2-2006-1112 OMA-POC-POCv2-2006-1124 OMA-POC-POCv2-2006-1126 OMA-POC-POCv2-2006-1139R01 OMA-POC-POCv2-2006-1162r01 OMA-POC-POCv2-2006-1166r01 OMA-POC-POCv2-2006-1078R02 OMA-POC-POCv2-2006-1143r01 OMA-POC-POCv2-2006-1160R02 OMA-POC-POCv2-2006-1161R01
	01 Dec 2006	All	Updated with agreed CRs: OMA-POC-POCv2-2006-0935R01 OMA-POC-POCv2-2006-1114R01 OMA-POC-POCv2-2006-1123R01 OMA-POC-POCv2-2006-1127R01
	19 Dec 2006	All	History box reformatted Transformed to English UK, Editorial cleanup (subclause numbering, spelling errors, etc). Removed Annex X disclaimer and moved History to the right place at the end. Updated with agreed CRs: OMA-POC-POCv2-2006-1294R01 OMA-POC-POCv2-2006-0924R06 OMA-POC-POCv2-2006-0925R03 OMA-POC-POCv2-2006-0929R04 OMA-POC-POCv2-2006-0954R01 OMA-POC-POCv2-2006-1081R02 OMA-POC-POCv2-2006-1102R02 OMA-POC-POCv2-2006-1109R03 OMA-POC-POCv2-2006-1206R03 OMA-POC-POCv2-2006-1240R02 OMA-POC-POCv2-2006-1242R02 OMA-POC-POCv2-2006-1281 OMA-POC-POCv2-2006-1283R01 OMA-POC-POCv2-2006-1284R01 OMA-POC-POCv2-2006-1286 OMA-POC-POCv2-2006-1287 OMA-POC-POCv2-2006-1290 OMA-POC-POCv2-2006-1291R01 OMA-POC-POCv2-2006-1293R02 OMA-POC-POCv2-2006-1295R01 OMA-POC-POCv2-2006-1296R02 OMA-POC-POCv2-2006-1298R01 OMA-POC-POCv2-2006-1299 OMA-POC-POCv2-2006-1316R01 OMA-POC-POCv2-2006-1318R01 OMA-POC-POCv2-2006-1333 OMA-POC-POCv2-2006-1334 OMA-POC-POCv2-2006-1342R01 OMA-POC-POCv2-2006-1353 OMA-POC-POCv2-2006-1405R02 OMA-POC-POCv2-2006-1408R01 OMA-POC-POCv2-2006-1415 OMA-POC-POCv2-2006-1419R01 OMA-POC-POCv2-2006-1420

Document Identifier	Date	Sections	Description
			OMA-POC-POCv2-2006-1428 OMA-POC-POCv2-2006-1434 OMA-POC-POCv2-2006-1435 OMA-POC-POCv2-2006-1470R01 OMA-POC-POCv2-2006-1477R01 OMA-POC-POCv2-2006-1478R04
	15 Feb 2007	All	OMA-POC-POCv2-2007-0013R03 OMA-POC-POCv2-2007-0005 OMA-POC-POCv2-2007-0047 OMA-POC-POCv2-2007-0062 OMA-POC-POCv2-2007-0104 OMA-POC-POCv2-2007-0224 OMA-POC-POCv2-2007-0247 OMA-POC-POCv2-2007-0042R02 OMA-POC-POCv2-2007-0225R01 OMA-POC-POCv2-2007-0222R01
	22 Mar 2007	All	Updated with agreed CRs with the following exception: According to PoC WG decision the definition of Inviting PoC Client shall be introduced by editors without CR. Agreed CRs: OMA-POC-POCv2-2007-0293r01 OMA-POC-POCv2-2007-0223R03 OMA-POC-POCv2-2007-0155R04 OMA-POC-POCv2-2007-0196R02 OMA-POC-POCv2-2007-0152R02 OMA-POC-POCv2-2007-0052R01 OMA-POC-POCv2-2007-0050R01 OMA-POC-POCv2-2007-0045R01 OMA-POC-POCv2-2007-0049R02 OMA-POC-POCv2-2007-0031R01 OMA-POC-POCv2-2007-0159R03
	30 Mar 2007	All	OMA-POC-POCv2-2007-0380 OMA-POC-POCv2-2007-0375 OMA-POC-POCv2-2007-0366 OMA-POC-POCv2-2007-0354 OMA-POC-POCv2-2007-0355R01 OMA-POC-POCv2-2007-0411R02 OMA-POC-POCv2-2007-0352 OMA-POC-POCv2-2007-0351R01 OMA-POC-POCv2-2007-0343 OMA-POC-POCv2-2007-0333 (relevant parts) OMA-POC-POCv2-2007-0329R03 OMA-POC-POCv2-2007-0328 OMA-POC-POCv2-2007-0327 OMA-POC-POCv2-2007-0321 OMA-POC-POCv2-2007-0326 OMA-POC-POCv2-2007-0325R01 OMA-POC-POCv2-2007-0324 OMA-POC-POCv2-2007-0323R03 OMA-POC-POCv2-2007-0322R02 OMA-POC-POCv2-2007-0319 OMA-POC-POCv2-2007-0313R02 OMA-POC-POCv2-2007-0311R02 OMA-POC-POCv2-2007-0310R03 OMA-POC-POCv2-2007-0309 OMA-POC-POCv2-2007-0305
	24 Apr 2007	All	OMA-POC-POCv2-2007-0238R03

Document Identifier	Date	Sections	Description
			OMA-POC-POCv2-2007-0353R01 OMA-POC-POCv2-2007-0403R03 OMA-POC-POCv2-2007-0486 OMA-POC-POCv2-2007-0489 OMA-POC-POCv2-2007-0492 OMA-POC-POCv2-2007-0493 OMA-POC-POCv2-2007-0538 OMA-POC-POCv2-2007-0549 OMA-POC-POCv2-2007-0550 OMA-POC-POCv2-2007-0551 OMA-POC-POCv2-2007-0571 OMA-POC-POCv2-2007-0586 OMA-POC-POCv2-2007-0589 OMA-POC-POCv2-2007-0590 OMA-POC-POCv2-2007-0591 OMA-POC-POCv2-2007-0593R01 OMA-POC-POCv2-2007-0239R02 OMA-POC-POCv2-2007-0263R04 OMA-POC-POCv2-2007-0433R04 OMA-POC-POCv2-2007-0456R01 OMA-POC-POCv2-2007-0487 OMA-POC-POCv2-2007-0554R01 OMA-POC-POCv2-2007-0610r01 OMA-POC-POCv2-2007-0619r01 OMA-POC-POCv2-2007-0633R01 OMA-POC-POCv2-2007-0657R02
	25 Apr 2007	All	OMA-POC-POCv2-2007-0616 OMA-POC-POCv2-2007-0497R04 OMA-POC-POCv2-2007-0588R01
	03 May 2007	All	OMA-POC-POCv2-2007-0410R03 OMA-POC-POCv2-2007-0491R01 OMA-POC-POCv2-2007-0592R02 OMA-POC-POCv2-2007-0609R01
	23 May 2007	All	OMA-POC-POCv2-2007-0384R01 OMA-POC-POCv2-2007-0490R01 OMA-POC-POCv2-2007-0744 OMA-POC-POCv2-2007-0782r01 OMA-POC-POCv2-2007-0783r01 OMA-POC-POCv2-2007-0788r01 OMA-POC-POCv2-2007-0789r01 OMA-POC-POCv2-2007-0750 OMA-POC-POCv2-2007-0751 OMA-POC-POCv2-2007-0613R03 OMA-POC-POCv2-2007-0656R03 OMA-POC-POCv2-2007-0756r01 OMA-POC-POCv2-2007-0714 OMA-POC-POCv2-2007-0494R03 OMA-POC-POCv2-2007-0593R01 (correction) OMA-POC-POCv2-2007-0657R04
	30 May 2007	All	OMA-POC-POCv2-2007-0756r01 (correction) OMA-POC-POCv2-2007-0808R02 OMA-POC-POCv2-2007-0765R01 OMA-POC-POCv2-2007-0675R02 OMA-POC-POCv2-2007-0680R03
	18 Jun 2007	All	OMA-POC-POCv2-2007-0832 OMA-POC-POCv2-2007-0942 OMA-POC-POCv2-2007-0781R03

Document Identifier	Date	Sections	Description
			OMA-POC-POCv2-2007-0829 OMA-POC-POCv2-2007-0830 OMA-POC-POCv2-2007-0858 OMA-POC-POCv2-2007-0828R02 OMA-POC-POCv2-2007-0833 OMA-POC-POCv2-2007-0834R01 OMA-POC-POCv2-2007-0835 OMA-POC-POCv2-2007-0836 OMA-POC-POCv2-2007-0837 OMA-POC-POCv2-2007-0838R01 OMA-POC-POCv2-2007-0861R01 OMA-POC-POCv2-2007-0865R01 OMA-POC-POCv2-2007-0867 OMA-POC-POCv2-2007-0868R03 OMA-POC-POCv2-2007-0869 OMA-POC-POCv2-2007-0870R01 OMA-POC-POCv2-2007-0871R01 OMA-POC-POCv2-2007-0887R01 OMA-POC-POCv2-2007-0888R01 OMA-POC-POCv2-2007-0940 OMA-POC-POCv2-2006-1435 (correction)
	16 Jul 2007	All	OMA-POC-POCv2-2007-0964R01 OMA-POC-POCv2-2007-0985 OMA-POC-POCv2-2007-0987 OMA-POC-POCv2-2007-0989R02 OMA-PoC-PoCv2-2007-1008 OMA-POC-POCv2-2007-1026R02
	06 Aug 2007	All	OMA-POC-POCv2-2007-0972R03 OMA-POC-POCv2-2007-0979R03 OMA-POC-POCv2-2007-0999R02 OMA-POC-POCv2-2007-1002 OMA-POC-POCv2-2007-1036R01 OMA-POC-POCv2-2007-1042R03 OMA-POC-POCv2-2007-1048 OMA-POC-POCv2-2007-1049
	21 Aug 2007	All	OMA-POC-POCv2-2007-1023 OMA-POC-POCv2-2007-1066R01 OMA-POC-POCv2-2007-1071R01 OMA-POC-POCv2-2007-1073R01
	22 Aug 2007	All	OMA-POC-POCv2-2007-1095r01
	23 Aug 2007	All	Editorial changes prior to sending the ERP to REL.
Candidate version: OMA-TS-PoC_UserPlane-V2_0	02 Oct 2007	All	Status changed to Candidate by TP TP ref # OMA-TP-2007-0343R01- INP_POC_V2_0_ERP_for_Candidate_Approval General editorial clean-up of styles for publication.
Draft versions: OMA-TS-PoC_UserPlane-V2_0	24 Oct 2007	All	Inclusion of CRs: OMA-POC-POCv2-2007-1101 OMA-POC-POCv2-2007-1102R01 OMA-POC-POCv2-2007-1103R01 OMA-POC-POCv2-2007-1104 OMA-POC-POCv2-2007-1105 OMA-POC-POCv2-2007-1107R01 OMA-POC-POCv2-2007-1108R01 OMA-POC-POCv2-2007-1111 OMA-POC-POCv2-2007-1112 OMA-POC-POCv2-2007-1113R01 OMA-POC-POCv2-2007-1114R01

Document Identifier	Date	Sections	Description
			OMA-POC-POCv2-2007-1124R01 OMA-POC-POCv2-2007-1125R01 OMA-POC-POCv2-2007-1126 OMA-POC-POCv2-2007-1129
	02 Nov 2007	6.4.4	Editorial change: Size of Figure 11 reduced to fit the page.
	12 Nov 2007	Sections 6 & 7	Inclusion of CR: OMA-POC-POCv2-2007-1136R02
Candidate version: OMA-TS-PoC_UserPlane-V2_0	11 Dec 2007	n/a	Status changed to Candidate by TP TP ref # OMA-TP-2007-0468- INP_PoC_V2_0_ERP_for_Notification
Draft version: OMA-TS-PoC_UserPlane-V2_0	20 Dec 2007	2.1, 5.3, 5.4, 6.5.1.2.7	Inclusion of CRs: OMA-POC-POCv2-2007-1157 OMA-POC-POCv2-2007-1165
Candidate version: OMA-TS-PoC_UserPlane-V2_0	26 Feb 2008	n/a	Status changed to Candidate by TP TP ref # OMA-TP-2008-0098- INP_Push_to_talk_over_Cellular_V2_0_ERP_for_Notification
Draft version: OMA-TS-PoC_UserPlane-V2_0	06 Mar 2008	6.3.7	Inclusion of CR: OMA-POC-POCv2-2007-1139
Candidate version: OMA-TS-PoC_UserPlane-V2_0	21 Apr 2008	n/a	Status changed to Candidate by TP TP ref # OMA-TP-2008-0169- INP_Push_to_talk_over_Cellular_V2_0_ERP_for_Notification
Draft version: OMA-TS-PoC_UserPlane-V2_0	22 April 2008	7.8.1	Inclusion of CR: OMA-POC-POCv2-2008-0043
Candidate version: OMA-TS-PoC_UserPlane-V2_0	07 May 2008	n/a	Status changed to Candidate by TP TP ref # OMA-TP-2008-0189- INP_Push_to_talk_over_Cellular_V2_0_ERP_for_Notification

Appendix B. Static Conformance Requirement (SCR) (Normative)

The SCRs defined in the following tables include SCRs for:

- The PoC Client; and,
- the PoC Server.

The SCRs are defined as described in [OMA_SCR_Rules].

Each SCR table identifies a list of supported features as:

- Item: Identifier for a feature. It MUST be of type ScrItem.
- Function: Short description of the feature.
- Reference: Section(s) of the specification(s) with more details on the feature.
- Requirement: Other features required by this feature, independent of whether those other features are mandatory or optional. The notation in the dependency grammar MUST be used for this column when other features are required, else the column MUST be left empty.

Dependency grammar used in this section is specified in [OMA_SCR_Rules]:

```

TerminalExpression =      ScrReference
                        / NOT TerminalExpression
                        / TerminalExpression LogicalOperator TerminalExpression
                        / "(" TerminalExpression ")"

ScrReference =          ScrItem
                        / ScrGroup

ScrItem =              SpecScrName "-" GroupType "-" DeviceType "-" NumericId "-" Status
                        / SpecScrName "-" DeviceType "-" NumericId "-" Status

ScrGroup =             SpecScrName ":" FeatureType
                        / SpecScrName "-" GroupType "-" DeviceType "-" FeatureType

SpecScrName = 1*Character;
GroupType = 1*Character;
DeviceType = "C" / "S"; C – client, S – server
NumericId = Number Number Number
Status = "M" / "O"; M - Mandatory, O - Optional
LogicalOperator = "AND" / "OR"; AND has higher precedence than OR and OR is inclusive
FeatureType = "MCF" / "OCF" / "MSF" / "OSF";
Character = %x41-5A;

```

NOTE: The following convention applies for the labels regarding the PoC version:

- PoCv1.0 - SCR Item that is the same in PoCv2.0 as it is in PoCv1.0.
- PoCv2.0 - SCR Item that is new in PoCv2.0.
- PoCv1.0mod - SCR Item that exists in PoCv1.0, but modifications in PoCv2.0.

B.1 PoC Session Initiation, Joining and Release (SJR)

This subclause describes the Static Conformance Requirement for functions needed to support PoC Session Initiation, Joining and Release.

B.1.1 PoC Client

Item	Function	Reference	Requirement
POC_UP-SJR-C-001-O	Support of Pre-established PoC Session PoCv1.0mod	6.2.6, 6.5.9, 6.5.12, 6.5.13	
POC_UPPOC_UP-SJR-C-002-O	A PoC Client supports several Pre-established PoC Sessions at a time. PoCv1.0	6.2.6	POC_UPPOC_UP-SJR-C-001-O
POC_UPPOC_UP-SJR-C-003-M	Support of RTP Media packets for PoC Speech, non-queuing PoCv1.0	5.1, 5.2, 5.3, 5.4, 6.2.5.2.3, 6.2.5.3.6, 6.2.5.4.1, 6.2.5.5.5, 6.2.5.6.1, 6.2.5.6.4	
POC_UP-SJR-C-004-O	Support of RTP Media packets for PoC Speech, queuing. PoCv1.0	6.2.9.3.6, 6.2.9.7.1 7.7.1	POC_UP-MBQ-C-001-O
POC_UP-SJR-C-005-O	Support of RTP Media packets for Audio and Video, non-queuing. PoCv2.0	5.1, 5.2, 5.3, 5.4, 6.2.5.2.3, 6.2.5.3.6, 6.2.5.4.1, 6.2.5.5.5, 6.2.5.6.1, 6.2.5.6.4	
POC_UP-SJR-C-006-O	Support of RTP Media packets for Audio and Video, queuing. PoCv2.0	6.2.9.3.6, 6.2.9.7.1 7.7.1	POC_UP-MBQ-C-001-O
POC_UP-SJR-C-007-O	Support of MSRP for Discrete Media bound to a Media-floor Control Entity. PoCv2.0	5.1, 5.4, 5.5, 6.2.10.2.3, 6.2.10.3.3, 6.2.10.4.1	POC_UP-MBN-C-002-O AND POC_UP-MBN-C-004-O AND POC_UP-MBN-C-007-O AND POC_UP-MBN-C-009-O AND POC_UP-MBN-C-011-O AND POC_UP-MBN-C-013-O AND POC_UP-MBN-C-015-O AND POC_UP-MBN-C-017-O
POC_UP-SJR-C-008-O	Provides notification to the PoC User when receiving Media Burst Idle message or when receiving a Media Burst Request timeout or when receiving a Media Burst Deny message PoCv1.0	6.2.5.2.1, 6.2.5.2.5, 6.2.10.3.1	
POC_UP-SJR-C-009-O	Provides information about the stop talking timer. PoCv1.0	6.2.5.3.1, 6.2.9.7.3, 6.2.10.3.1	
POC_UP-SJR-C-010-O	Support Media buffering capability. PoCv2.0	6.2.5.4.1	
POC_UP-SJR-C-011-O	Supports Limited Segment Media Buffering capability. PoCv2.0	6.2.5.1.1, 6.2.5.9	POC_UP-SJR-C-010-O

B.1.2 PoC Server

Item	Function	Reference	Requirement
POC_UP-SJR-S-001-O	Support of Pre-established PoC Sessions. (Participating PoC Function) PoCv1.0mod	6.3.6, 6.5.9, 6.5.12, 6.5.13	POC_UP-MBN-S-001-O
POC_UP-SJR-S-002-O	Support for PoC Speech. (Participating PoC Function) PoCv1.0	5.1, 5.2, 5.3, 5.4, 6.3.5, 7.7.2	POC_UP-MBN-S-001-O
POC_UP-SJR-S-003-M	Support for PoC Speech. (Controlling PoC Function) PoCv1.0	5.1, 5.2, 5.3, 5.4, 7.7.3	
POC_UP-SJR-S-004-O	Supports buffering of RTP Media packets, Unconfirmed Indication. (Controlling PoC Function) PoCv1.0	7.8.3	
POC_UP-SJR-S-005-O	Support for Audio and Video. (Participating PoC Function) PoCv2.0	5.1, 5.2, 5.3, 5.4, 6.3.5, 7.7.2	POC_UP-MBN-S-001-O
POC_UP-SJR-S-006-M	Support for Audio and Video. (Controlling PoC Function) PoCv2.0	5.1, 5.2, 5.3, 5.4, 7.7.3	
POC_UP-SJR-S-007-O	Support for Discrete Media bound to a Media-floor Control Entity. (Participating PoC Function) PoCv2.0	5.1, 5.4, 5.5, 6.3.5	POC_UP-MBN-S-001-O
POC_UP-SJR-S-008-O	Support for Discrete Media bound to a Media-floor Control Entity. (Controlling PoC Function) PoCv2.0	5.1, 5.4, 5.5	POC_UP-MBN-S-025-O AND POC_UP-MBN-S-021-O AND POC_UP-MBN-S-019-O AND POC_UP-MBN-S-017-O AND POC_UP-MBN-S-014-O AND POC_UP-MBN-S-012-O
POC_UP-SJR-S-009-O	Supports buffering of RTP Media packets. (Controlling PoC Function) PoCv2.0	6.4.4.3.4	
POC_UP-SJR-S-010-O	Supports Limited Segment Media Buffering capability. (Controlling PoC Function) PoCv2.0	6.4.4.3.1, 6.4.4.3.2, 6.4.4.3.7, 6.4.4.3.9	POC_UP-SJR-S-009-O

B.2 Media Burst Control, no queuing (MBN)

This subclause describes the basic Static Conformance Requirements for Media Burst Control when queuing of Media Burst requests is not negotiated.

B.2.1 PoC Client

Item	Function	Reference	Requirement
POC_UP-MBN-C-001-M	Media Burst request during a PoC Session: Request when floor is idle -> Media Burst granted. (Continuous Media) PoCv1.0	5.2.1, 5.4, 6.2.5.2.1, 6.2.5.2.4, 6.2.5.3.1, 6.2.5.2.2, 6.5.2, 6.5.3, 6.5.7.	
POC_UP-MBN-C-002-O	Media Burst request during a PoC Session: Request when floor is idle -> Media Burst granted. (Discrete Media) PoCv2.0	5.2.1, 5.4, 6.2.10.2.1, 6.2.10.22, 6.2.10.2.4, 6.2.10.3.1, 6.5.2, 6.5.3, 6.5.7.	POC_UP-SJR-C-007-O
POC_UP-MBN-C-003-M	Media Burst request during a PoC Session Request when floor is not idle -> Media Burst deny. (Continuous Media) PoCv1.0	5.2.1, 5.4, 6.2.5.2.4, 6.2.5.3.3, 6.5.2, 6.5.4, 6.5.4.1.1	
POC_UP-MBN-C-004-O	Media Burst request during a PoC Session Request when floor is not idle -> Media Burst deny. (Discrete Media) PoCv2.0	5.2.1, 5.4, 6.2.10.2.4, 6.2.10.3.2, 6.5.2, 6.5.4, 6.5.4.1.1	POC_UP-SJR-C-007-O
POC_UP-MBN-C-005-M	Implicit Media Burst request (INVITE) in the beginning of a PoC Session (1-1, Ad-hoc or Pre-arranged PoC Session): Request when floor is idle -> Media Burst granted. (PoC Speech) PoCv1.0	5.2.1, 5.4, 6.2.5.1.1, 6.2.5.3.1, 6.2.5.1.2, 6.2.5.2.2, 6.5.3, 6.5.7	

Item	Function	Reference	Requirement
POC_UP-MBN-C-006-M	Re-joining a PoC Group Session or joining a Chat PoC Group Session. Request when floor is idle -> Media Burst Idle. (Continuous Media) PoCv1.0	5.2.1, 5.4, 6.2.5.1.1, 6.2.5.2.1, 6.5.6	
POC_UP-MBN-C-007-O	Re-joining a PoC Group Session or joining a Chat PoC Group Session. Request when floor is idle -> Media Burst Idle. (Discrete Media) PoCv2.0	5.2.1, 5.4, 6.2.10.1.1, 6.2.10.2.2, 6.5.6	POC_UP-SJR-C-007-O
POC_UP-MBN-C-008-M	Re-joining a PoC Group Session or joining a Chat PoC Group Session. Request when floor is not idle -> Media Burst Taken (Continuous Media) PoCv1.0	5.2.1, 5.4, 6.2.5.1.1, 6.2.5.3.2, 6.5.7	
POC_UP-MBN-C-009-O	Re-joining a PoC Group Session or joining a Chat PoC Group Session. Request when floor is not idle -> Media Burst Taken (Discrete Media) PoCv2.0	5.2.1, 5.4, 6.2.10.1.1, 6.2.10.2.1, 6.5.7	POC_UP-SJR-C-007-O
POC_UP-MBN-C-010-M	Media Burst release. (Continuous Media) PoC1.0	5.2.1, 5.4, 6.2.5.2.1, 6.2.5.4.2, 6.2.5.5.3, 6.5.5, 6.5.6	
POC_UP-MBN-C-011-O	Media Burst release. (Discrete Media) PoCv2.0	5.2.1, 5.4, 6.2.10.2.2, 6.2.10.4.2, 6.2.10.5.1, 6.5.5, 6.5.6	POC_UP-SJR-C-007-O
POC_UP-MBN-C-012-M	Media Burst revoke. (Continuous Media) PoCv1.0	5.2.1, 5.4, 6.2.5.2.1, 6.2.5.4.3, 6.2.5.6.5, 6.2.5.5.3, 6.5.5, 6.5.6, 6.5.8	
POC_UP-MBN-C-013-O	Media Burst revoke. (Discrete Media) PoCv2.0	5.2.1, 5.4, 6.2.10.2.2, 6.2.10.4.3, 6.2.10.4.2, 6.2.10.5.1, 6.5.5, 6.5.6, 6.5.8	POC_UP-SJR-C-007-O

Item	Function	Reference	Requirement
POC_UP-MBN-C-014-M	Media Burst request not received by PoC Server or the response to the Media Burst request is not received. (Continuous Media) PoCv1.0	5.2.1, 5.4, 6.2.5.3.4, 6.2.5.3.5, 6.5.2	
POC_UP-MBN-C-015-O	Media Burst request not received by PoC Server or the response to the Media Burst request is not received. (Discrete Media) PoCv2.0	5.2.1, 5.4, 6.2.10.3.4, 6.2.10.3.5, 6.5.2	POC_UP-SJR-C-007-O
POC_UP-MBN-C-016-M	Media Burst release not received by PoC Server. (Continuous Media) PoCv1.0	5.2.1, 5.4, 6.2.5.5.1, 6.2.5.5.2, 6.5.5	
POC_UP-MBN-C-017-O	Media Burst release not received by PoC Server. (Discrete Media) PoCv2.0	5.2.1, 5.4, 6.2.10.5.2, 6.2.10.5.3	POC_UP-SJR-C-007-O
POC_UP-MBN-C-018-O	Supports Media Burst permission confirmation of PoC User and release permission before sending Media. PoCv2.0	6.2.5.4	

B.2.2 PoC Server

Item	Function	Reference	Requirement
POC_UP-MBN-S-001-O	The Participating PoC Function is in the Media path. (Participating PoC Function) PoCv1.0	4.2	POC_UP-SJR-S-002-O AND POC_UP-SJR-S-005-O AND POC_UP-SJR-S-007-O AND POC_UP-MBN-S-002-O AND POC_UP-MBN-S-003-O AND POC_UP-MBN-S-004-O AND POC_UP-MBN-S-005-O AND POC_UP-MBN-S-006-O AND POC_UP-MBN-S-007-O AND POC_UP-MBN-S-008-O AND POC_UP-MBN-S-009-O AND POC_UP-MBN-S-010-O
POC_UP-MBN-S-002-O	Media Burst request during a PoC Session. Request when floor is idle -> Media Burst granted. (All Media Types) (Participating PoC Function) PoCv1.0	5.2.1, 5.4, 6.3.5, 6.5.2, 6.5.3, 6.5.7.	POC_UP-MBN-S-001-O

Item	Function	Reference	Requirement
POC_UP-MBN-S-003-O	Media Burst request during a PoC Session. Request when floor is not idle -> Media Burst deny. (Participating PoC Function) (All Media Types) PoCv1.0	5.2.1, 5.4, 6.3.5, 6.5.2, 6.5.2.1, 5.4, 6.5.4.1.1	POC_UP-MBN-S-001-O
POC_UP-MBN-S-004-O	Re-joining an PoC Group Session. Request when floor is idle -> Media Burst Idle. (Participating PoC Function) (All Media) PoCv1.0	5.2.1, 5.4, 6.3.5, 6.5.6	POC_UP-MBN-S-001-O
POC_UP-MBN-S-005-O	Re-joining a PoC Group Session or joining a Chat PoC Group Session. Request when floor is not idle -> Media Burst Taken (Participating PoC Function) (All Media) PoCv1.0	5.2.1, 5.4, 6.3.5, 6.5.7	POC_UP-MBN-S-001-O
POC_UP-MBN-S-006-O	Media Burst release (All Media Types) (Participating PoC Function) PoCv1.0	5.2.1, 5.4, 6.3.5, 6.5.5, 6.5.6	POC_UP-MBN-S-001-O
POC_UP-MBN-S-007-O	Media Burst revoke. (All Media Types) (Participating PoC Function) PoCv1.0	5.2.1, 5.4, 6.3.5, 6.5.5, 6.5.6, 6.5.8	POC_UP-MBN-S-001-O
POC_UP-MBN-S-008-O	Media Burst request not received by PoC Server. (Participating PoC Function) (All Media Types) PoCv1.0	5.2.1, 5.4, 6.3.5, 6.5.2	POC_UP-MBN-S-001-O

Item	Function	Reference	Requirement
POC_UP-MBN-S-009-O	Media Burst Control (granted or deny) not received by PoC Client (Participating PoC Function) (All Media Types) PoCv1.0	5.2.1, 5.4, 6.3.5, 6.5.2, 6.5.3, 6.5.4	POC_UP-MBN-S-001-O
POC_UP-MBN-S-010-O	Media Burst release not received by PoC Server. (Participating PoC Function) (All Media Types) PoCv1.0	5.2.1, 5.4, 6.3.5, 6.5.2, 6.5.5	POC_UP-MBN-S-001-O
POC_UP-MBN-S-011-M	Media Burst request during a PoC Session. Request when floor is idle -> Media Burst granted. (Controlling PoC Function) (Continuous Media) PoCv1.0	5.2.1, 5.4, 6.4.4.2.2, 6.4.4.3.1, 6.4.5.2.2, 6.4.5.2.3, 6.4.5.4.1, 6.5.2, 6.5.3, 6.5.7	
POC_UP-MBN-S-012-O	Media Burst request during a PoC Session. Request when floor is idle -> Media Burst granted. (Controlling PoC Function) (Discrete Media) PoCv2.0	5.2.1, 5.4, 6.4.6.2.2 and 6.4.6.3.1, 6.5.2, 6.5.3, 6.5.7	POC_UP-SJR-S-008-O
POC_UP-MBN-S-013-M	Media Burst request during a PoC Session. Request when floor is not idle -> Media Burst deny. (Controlling PoC Function) (Continuous Media) PoCv1.0	5.2.1, 5.4, 6.4.4.2.2, 6.4.5.3.3, 6.5.2, 6.5.2.1, 5.4, 6.5.4.1.1	
POC_UP-MBN-S-014-O	Media Burst request during a PoC Session. Request when floor is not idle -> Media Burst deny. (Controlling PoC Function) (Discrete Media) PoCv2.0	5.2.1, 5.4, 6.4.6.3.7, 6.5.2, 6.5.2.1, 5.4, 6.5.4.1.1	POC_UP-SJR-S-008-O

Item	Function	Reference	Requirement
POC_UP-MBN-S-015-M	<p>Implicit Media Burst request (INVITE) in the beginning of a PoC Session (1-1, Ad-hoc or Pre-arranged PoC Session).</p> <p>Request when floor is idle -> Media Burst granted.</p> <p>(Controlling PoC Function)</p> <p>(PoC Speech)</p> <p>PoCv1.0</p>	5.2.1, 5.4, 6.4.4.1.1, 6.4.4.2.2, 6.4.4.3.1, 6.4.5.1.1, 6.4.5.4.1, 6.5.3, 6.5.7	
POC_UP-MBN-S-016-M	<p>Re-joining an PoC Group Session:</p> <p>Request when floor is idle -> Media Burst Idle.</p> <p>(Controlling PoC Function)</p> <p>(Continuous Media)</p> <p>PoCv1.0</p>	5.2.1, 5.4, 6.4.1.1, 6.4.4.2.1, 6.4.5.1.1, 6.4.5.4.1, 6.5.6	
POC_UP-MBN-S-017-O	<p>Re-joining an PoC Group Session.</p> <p>Request when floor is idle -> Media Burst Idle.</p> <p>(Controlling PoC Function)</p> <p>(Discrete Media)</p> <p>PoCv2.0</p>	5.2.1, 5.4, 6.4.6.1.1, 6.4.6.2.1, 6.5.6	POC_UP-SJR-S-008-O
POC_UP-MBN-S-018-M	<p>Re-joining a PoC Group Session or joining a Chat PoC Group Session.</p> <p>Request when floor is not idle -> Media Burst Taken.</p> <p>(Controlling PoC Function)</p> <p>(Continuous Media)</p> <p>PoCv1.0</p>	5.2.1, 5.4, 6.4.5.1.1, 6.4.5.3.1, 6.5.7	
POC_UP-MBN-S-019-O	<p>Re-joining a PoC Group Session or joining a Chat PoC Group Session.</p> <p>Request when floor is not idle -> Media Burst Taken.</p> <p>(Controlling PoC Function)</p> <p>(Discrete Media)</p> <p>PoCv2.0</p>	5.2.1, 5.4, 6.5.7	POC_UP-SJR-S-008-O
POC_UP-MBN-S-020-M	<p>Media Burst release.</p> <p>(Controlling PoC Function)</p> <p>(Continuous Media)</p> <p>PoCv1.0mod</p>	5.2.1, 5.4, 6.4.4.3.5, 6.4.4.2.1, 6.4.4.5, 6.5.5, 6.5.6	

Item	Function	Reference	Requirement
POC_UP-MBN-S-021-O	Media Burst release. (Controlling PoC Function) (Discrete Media) PoCv2.0	5.2.1, 5.4, 6.4.6.3.3, 6.4.6.2.1, 6.4.6.5, 6.5.5, 6.5.6	POC_UP-SJR-S-008-O
POC_UP-MBN-S-022-M	Media Burst revoke. (Controlling PoC Function) (Continuous Media) PoCv1.0	5.2.1, 5.4, 6.4.4.3.3, 6.4.4.5.1, 6.4.4.5.3, 6.4.4.2.1, 6.4.5.4.4, 6.4.5.5.1, 6.4.5.5.5, 6.5.5, 6.5.6, 6.5.8, 6.5.8.1.2	
POC_UP-MBN-S-023-O	Media Burst revoke. (Controlling PoC Function) (Discrete Media) PoCv2.0	5.2.1, 5.4, 6.4.6.3.4, 6.4.6.4.1, 6.4.6.4.2, 6.4.6.2.1, 6.5.5, 6.5.6, 6.5.8, 6.5.8.1.5	POC_UP-SJR-S-008-O
POC_UP-MBN-S-024-M	Media Burst Control (granted or deny) not received by PoC Client. (Controlling PoC Function) (Continuous Media) PoCv1.0	5.2.1, 5.4, 6.4.5.4.6, 6.4.5.2.1, 6.4.5.3.3, 6.4.5.5.2, 6.4.5.5.3, 6.4.5.6.1, 6.4.5.6.2, 6.4.5.6.3, 6.4.4.3.7, 6.4.4.3.2, 6.4.4.2.1, 6.4.4.5.1, 6.4.4.5.5, 6.5.2, 6.5.3, 6.5.2.1, 5.4, 6.5.6, 6.5.8	
POC_UP-MBN-S-025-O	Media Burst Control (granted or deny) not received by PoC Client. (Controlling PoC Function) (Discrete Media) PoCv2.0	5.2.1, 5.4, 6.4.6.3.5, 6.4.6.3.6, 6.4.6.3.7, 6.4.6.4.1, 6.4.6.4.3, 6.5.2, 6.5.3, 6.5.2.1, 5.4, 6.5.6, 6.5.8	POC_UP-SJR-S-008-O
POC_UP-MBN-S-026-M	Request when no other Participants in the PoC Session or if no other Participant is connected to the Media- floor Control Entity -> Media Burst deny. (Controlling PoC Function) (Continuous Media) PoCv1.0	5.2.1, 5.4, 6.4.5.2.3	
POC_UP-MBN-S-027-M	Request when no other Participants is in the PoC Session or if no other Participant is connected to the Media- floor Control Entity -> Media Burst deny. (Controlling PoC Function) (Discrete Media) PoCv2.0	6.4.6.2.2	POC_UP-SJR-S-008-O

B.3 Multiple Session Sessions (MUS)

This subclause describes the Static Conformance Requirement (SCR) for Simultaneous PoC Sessions.

B.3.1 PoC Client

Item	Function	Reference	Requirement
POC_UP-MUS-C-001-O	Support of Simultaneous PoC Sessions. PoCv1.0	6.2.7, 6.2.8	POC_UP-MUS-C-002-O
POC_UP-MUS-C-002-O	Participant in more than one PoC Session is able to monitor the MBCP traffic of all PoC Sessions, he participates in. (Continuous Media) PoCv1.0	7.5.1	POC_UP-MUS-C-001-O
POC_UP-MUS-C-003-O	Participant in more than one PoC Sessions is able to monitor the MBCP traffic of other PoC Sessions, when talking or receiving Media to the selected PoC Session. (Continuous Media) PoCv1.0	6.2.7.3, 6.2.7.4, 7.5.1	POC_UP-MUS-C-001-O
POC_UP-MUS-C-004-O	Sends RTP Media packets to any of the Simultaneous PoC Sessions according to the PoC User selection. (Continuous Media) PoCv1.0	5.3, 7.5.1	POC_UP-MUS-C-001-O
POC_UP-MUS-C-004-O	The PoC Client can have more than one PoC Sessions established at a time. PoCv1.0	6.2.7	POC_UP-MUS-C-001-O

B.3.2 PoC Server

Item	Function	Reference	Requirement
POC_UP-MUS-S-001-O	Support of simultaneous PoC Sessions (Participating PoC Function) PoCv1.0	6.3.7, 6.3.8	POC_UP-MUS-S-002-O AND POC_UP-MUS-S-004-O
POC_UP-MUS-S-002-O	Participant in more than one PoC Session is able to monitor the MBCP traffic of all PoC Sessions, he participates in. (Participating PoC Function) (Continuous Media) PoCv1.0	7.5.2	POC_UP-MUS-S-001-O

Item	Function	Reference	Requirement
POC_UP-MUS-S-003-O	Participant in more than one PoC Sessions is able to monitor the MBCP traffic of other PoC Sessions, when talking or listening to the selected PoC Session. (Participating PoC Function) (Continuous Media) PoCv1.0	7.5.2	POC_UP-MUS-S-001-M
POC_UP-MUS-S-004-O	Discard RTP Media packets of the PoC Sessions not selected for transmitting to the PoC Client. (Participating PoC Function) PoCv1.0	7.7.2	POC_UP-MUS-S-001-M
POC_UP-MUS-S-005-O	Sends a RTCP SR message to the PoC Client concerning the PoC Session, which was interrupted due to activity in another PoC Session. (Participating PoC Function) PoCv1.0	7.5.2	POC_UP-MUS-S-001-M
POC_UP-MUS-S-006-O	Modifies the RTCP RR and SR messages sent between the PoC Client and the PoC Server to improve the accuracy of the quality feedback in the case of interrupted Media Burst. (Participating PoC Function) PoCv1.0	5.2.1, 5.4, 7.5.2	POC_UP-MUS-S-001-M
POC_UP-MUS-S-007-O	In the case of changing from one PoC Session to another and starting to transfer Media packets during an on-going Media Burst the PoC Server sends a MBCP Media Burst Taken message prior to the first Media packet being sent to the PoC Client. (Participating PoC Function) PoCv1.0	7.5.2	POC_UP-MUS-S-001-M

B.4 PoC Box (PBO)

B.4.1 PoC Client

Item	Function	Reference	Requirement
POC_UP-PBO-C-001-O	Support of PoC Box. PoCv2.0	6.2	SJR:MCF AND MBN:MCF

B.4.2 PoC Server

Not applicable

B.4.3 NW PoC Box

Item	Function	Reference	Requirement
POC_UP-PBO-S-001-O	Support of NW PoC Box. PoCv2.0	6.7	POC_UP-PBO-S-002-O AND POC_UP-PBO-S-003-O AND POC_UP-PBO-S-004-O AND POC_UP-PBO-S-006-O AND POC_UP-PBO-S-014-O
POC_UP-PBO-S-002-O	Media Burst request during a PoC Session. Request when floor is idle -> Media Burst granted (Only allowed in a 1-1 PoC Session) (Continuous Media) PoCv2.0	5.2.1, 5.4, 6.7.4.2.1, 6.7.4.2.2, 6.7.4.2.4, 6.7.4.3.1, 6.5.2, 6.5.3, 6.5.7	POC_UP-PBO-S-001-O
POC_UP-PBO-S-003-O	Media Burst request during a PoC Session. Request when floor is idle -> Media Burst granted (Only allowed in a 1-1 PoC Session) (Discrete Media) PoCv2.0	5.2.1, 5.4, 6.7.5.2.4, 7.7.5.3.1, 6.5.2, 6.5.3, 6.5.7	POC_UP-PBO-S-001-O
POC_UP-PBO-S-004-O	Media Burst request during a PoC Session. Request when floor is not idle -> Media Burst deny (Continuous Media) PoCv2.0	5.2.1, 5.4, 6.7.4.2.4, 6.7.4.3.3, 6.5.2, 6.5.2.1, 5.4, 6.5.4.1.1	POC_UP-PBO-S-001-O
POC_UP-PBO-S-005-O	Media Burst request during a PoC Session. Request when floor is not idle -> Media Burst deny (Discrete Media) PoCv2.0	5.2.1, 5.4, 6.7.5.2.4, 6.7.5.3.2, 6.5.2, 6.5.2.1, 5.4, 6.5.4.1.1	POC_UP-PBO-S-001-O
POC_UP-PBO-S-006-O	Media Burst release. (Continuous Media) PoCv2.0	5.2.1, 5.4, 6.7.4.2.1, 6.7.4.4.2, 6.7.4.5.3, 6.5.5, 6.5.6	POC_UP-PBO-S-001-O
POC_UP-PBO-S-007-O	Media Burst release. (Discrete Media) PoCv2.0	5.2.1, 5.4, 6.7.5.2.2, 6.7.5.4.2, 6.7.5.5.1, 6.5.5, 6.5.6	POC_UP-PBO-S-001-O

Item	Function	Reference	Requirement
POC_UP-PBO-S-008-O	Media Burst revoke. (Continuous Media) PoCv2.0	5.2.1, 5.4, 6.7.4.4.3, 6.7.4.6.1, 6.7.4.6.5, 6.7.4.5.3, 6.5.5, 6.5.6, 6.5.8, 6.5.8.1.2	POC_UP-PBO-S-001-O
POC_UP-PBO-S-009-O	Media Burst revoke. (Discrete Media) PoCv2.0	5.2.1, 5.4, 6.7.5.4.3, 6.7.5.4.2, 6.7.5.5.1, 6.5.5, 6.5.6, 6.5.8, 6.5.8.1.5	POC_UP-PBO-S-001-O
POC_UP-PBO-S-010-O	Media Burst request not received by PoC Server or the response to the Media Burst request is not received. (Continuous Media) PoCv2.0	5.2.1, 5.4, 6.7.4.3.4, 6.7.4.3.5, 6.5.2	POC_UP-PBO-S-001-O
POC_UP-PBO-S-011-O	Media Burst request not received by PoC Server or the response to the Media Burst request is not received. (Discrete Media) PoCv2.0	5.2.1, 5.4, 6.7.5.3.4, 6.7.5.3.5, 6.5.2	POC_UP-PBO-S-001-O
POC_UP-PBO-S-012-O	Media Burst release not received by PoC Server. (Continuous Media) PoCv2.0	5.2.1, 5.4, 6.7.4.5.1, 6.7.4.5.2, 6.5.5	POC_UP-PBO-S-001-O
POC_UP-PBO-S-013-O	Media Burst release not received by PoC Server. (Discrete Media) PoCv2.0	5.2.1, 5.4, 6.7.5.5.2, 6.7.5.5.3	POC_UP-PBO-S-001-O
POC_UP-PBO-S-014-O	Support for PoC Speech. PoCv2.0	5.1, 5.2, 5.3, 5.4, 6.7.4.2.3, 6.7.4.3.6, 6.7.4.4.1, 6.7.4.5.5, 6.7.4.6.4	POC_UP-PBO-S-001-O
POC_UP-PBO-S-015-O	Support for Audio and Video. PoCv2.0	5.1, 5.2, 5.3, 5.4, 6.7.4.3.6, 6.7.4.4.1, 6.7.4.5.5, 6.7.4.6.4	POC_UP-PBO-S-001-O
POC_UP-PBO-S-016-O	Support for Discrete Media bound to a Media-floor Control Entity. PoCv2.0	5.1, 5.4, 5.5, 6.7.5.2.3, 6.7.5.3.3, 6.7.5.4.1	POC_UP-PBO-S-001-O
POC_UP-PBO-S-017-O	Support Talker Identification PoCv2.0	8.4, 6.5.7	POC_UP-PBO-S-001-O

B.4.4 UE PoC Box

Item	Function	Reference	Requirement
POC_UP-PBO-C-001-O	Support of UE PoC Box. PoCv2.0	6.6	POC_UP-PBO-C-002-M AND POC_UP-PBO-C-007-M
POC_UP-PBO-C-002-M	Media Burst request during a PoC Session. Request when floor is idle -> Media Burst granted (Continuous Media) PoCv2.0	5.2.1, 5.4, 6.6.4.2.1, 6.6.4.2.2, 6.5.2, 6.5.3, 6.5.7	POC_UP-PBO-C-001-O
POC_UP-PBO-C-003-O	Media Burst request during a PoC Session. Request when floor is idle -> Media Burst granted (Discrete Media) PoCv2.0	5.2.1, 5.4, 6.6.5.2.1, 6.6.5.2.2, 6.5.2, 6.5.3, 6.5.7	POC_UP-PBO-C-001-O
POC_UP-PBO-C-004-O	Media Burst release. (Continuous Media) PoCv2.0	5.2.1, 5.4, 6.6.4.2.1, 6.5.6	POC_UP-PBO-C-001-O
POC_UP-PBO-C-005-O	Media Burst release. (Discrete Media) PoCv2.0	5.2.1, 5.4, 6.6.5.2.2, 6.5.6	POC_UP-PBO-C-001-O
POC_UP-PBO-C-006-O	Perform the mapping between the SSRC of the PoC Client granted a permission to send a Media Burst and the PoC Address or Nick Name or both and displays the PoC Address and Nick Name to the PoC User. PoCv2.0	6.6.4.2.2	POC_UP-PBO-C-001-O
POC_UP-PBO-C-007-M	Support for PoC Speech. PoCv2.0	5.1, 5.2, 5.3, 5.4, 6.6.4.2.3	POC_UP-PBO-C-001-O
POC_UP-PBO-C-008-O	Support for Audio and Video. PoCv2.0	5.1, 5.2, 5.3, 5.4, 6.6.4.2.3	POC_UP-PBO-C-001-O
POC_UP-PBO-C-009-O	Support for Discrete Media bound to a Media-floor Control Entity. PoCv2.0	5.1, 5.4, 5.5, 6.6.5.2.3	POC_UP-PBO-C-001-O
POC_UP-PBO-C-010-O	Support Talker Identification. PoCv2.0	8.4, 6.5.7	POC_UP-PBO-C-001-O

B.5 Advanced Revocation Alert (ARA)

B.5.1 PoC Client

Item	Function	Reference	Requirement
POC_UP-ARA-C-001-O	Support of Advanced Revocation Alert. (Continuous Media) PoCv2.0	6.2.5.3.1, 6.5.1.2.5, 6.2.5.4.2, 6.2.5.4.4, 6.5.3	
POC_UP-ARA-C-002-O	Display remaining time before revocation of the granted Media Burst. (Continuous Media) PoCv2.0	6.5.1.2.5, 6.5.3	POC_UP-MBN-C-001-O

B.5.2 PoC Server

Item	Function	Reference	Requirement
POC_UP-ARA-S-001-O	Support of Advanced Revocation Alert. (Controlling PoC Function) PoCv2.0	6.4.4.3.1, 6.4.4.3.7, 6.5.1.2.5, 6.5.3	
POC_UP-ARA-S-002-O	Display remaining time before revocation of the granted Media Burst. (Controlling PoC Function) PoCv2.0	6.5.1.2.5, 6.5.3	POC_UP-MBN-S-050-O

B.6 Media Burst Control, queuing (MBQ)

The following subclauses describe the additional Static Conformance Requirements for Media Burst Control when queuing of Media Burst requests has been negotiated as specified in [OMA-PoC-CP].

B.6.1 PoC Client

Item	Function	Reference	Requirement
POC_UP-MBQ-C-001-O	Support of Queuing Media Burst requests. PoCv1.0	6.2	MBN:MCF AND POC_UP-MBQ-C-002-O AND POC_UP-MBQ-C-005-O AND POC_UP-MBQ-C-006-O AND POC_UP-MBQ-C-007-O AND POC_UP-MBQ-C-008-O
POC_UP-MBQ-C-002-O	Media Burst request during a PoC Session queue support. Request when floor is not idle -> Media Burst request queued -> Media Burst granted. (Continuous Media) PoCv1.0	5.2.1, 5.4, 6.2.9.2.1, 6.2.9.3.7, 6.2.9.7.3, 6.5.2, 6.5.3, 6.5.11	POC_UP-MBQ-C-001-O

Item	Function	Reference	Requirement
POC_UP-MBQ-C-003-O	Media Burst request during a PoC Session queue + priority support. Request when floor is not idle -> Media Burst request queued indication -> Media Burst granted according to priority. (Continuous Media) PoCv1.0	6.5.1.2.4	POC_UP-MBQ-C-001-O
POC_UP-MBQ-C-004-O	Media Burst request during a PoC Session queue + timestamp support. Request when no one has permission to send a Media Burst -> Media Burst request queued indication -> Media Burst granted according to a timestamp value at the same priority level. (Continuous Media) PoCv1.0	6.5.1.2.2	POC_UP-MBQ-C-001-O
POC_UP-MBQ-C-005-O	Cancel of queued request (Continuous Media) PoCv1.0	5.2.1, 5.4, 6.2.9.7.5, 6.5.5	POC_UP-MBQ-C-001-O
POC_UP-MBQ-C-006-O	Media Burst request not received by PoC Server. (Continuous Media) PoCv1.0	5.2.1, 5.4, 6.2.9.3.4, 6.2.9.3.5	POC_UP-MBQ-C-001-O
POC_UP-MBQ-C-007-O	Media Burst Control (granted, queued or deny) not received by PoC Client. (Continuous Media) PoCv1.0	5.2.1, 5.4, 6.2.9.3.4, 6.2.9.3.5	POC_UP-MBQ-C-001-O
POC_UP-MBQ-C-008-O	Media Burst release not received by PoC Server. (Continuous Media) PoCv1.0	5.2.1, 5.4, 6.2.9.5	POC_UP-MBQ-C-001-O
POC_UP-MBQ-C-009-O	Media Burst request queued -> Queue Statue changes (Grant, Cancel or pre-empt) -> Receive Media Burst Queue Status message. (Controlling PoC Function) PoCv1.0	6.2.9.2.7, 6.2.9.6.6	POC_UP-MBQ-C-001-O

B.6.2 PoC Server

Item	Function	Reference	Requirement
POC_UP-MBQ-S-001-O	Media Burst request during a PoC Session queue support. Request when floor is not idle -> Media Burst request queued -> Media Burst granted. (Participating PoC Function) (All Media Type) PoCv1.0	5.2.1, 5.4, 6.3.5, 6.5.2, 6.5.3, 6.5.5, 6.5.11	POC_UP-MBN-S-001-O
POC_UP-MBQ-S-002-O	Support of Queuing Media Burst requests. (Controlling PoC Function) PoCv1.0	6.4	MBN:MSF AND POC_UP-MBQ-S-003-O AND POC_UP-MBQ-S-006 AND POC_UP-MBQ-S-007
POC_UP-MBQ-S-003-O	Media Burst request during a PoC Session queue support. Request when floor is not idle -> Media Burst request queued -> Media Burst granted. (Controlling PoC Function) (Continuous Media) PoCv1.0	5.2.1, 5.4, 6.4.5.3.3, 6.4.5.2.3, 6.4.4.2.2, 6.4.4.3.1, 6.5.1.2.2, 6.5.2, 6.5.3, 6.5.11	POC_UP-MBQ-S-002-O
POC_UP-MBQ-S-004O	Media Burst request during a PoC Session queue + priority support: Request when floor is not idle -> Media Burst request queued indication -> Media Burst granted according to priority (Controlling PoC Function) (Continuous Media) PoCv1.0	6.5.1.2.4	POC_UP-MBQ-S-002-O
POC_UP-MBQ-S-005-O	Media Burst request during a PoC Session queue + timestamp support. Request when no one has permission to send a Media Burst -> Media Burst request queued indication -> Media Burst granted according to a timestamp value at the same priority level. (Controlling PoC Function) (Continuous Media) PoCv1.0	6.5.1.2.2	POC_UP-MBQ-S-002-O

Item	Function	Reference	Requirement
POC_UP-MBQ-S-006-O	Cancel of queued request (Controlling PoC Function) (Continuous Media) PoCv1.0	5.2.1, 5.4, 6.4.5.3.4, 6.5.5	POC_UP-MBQ-S-002-O
POC_UP-MBQ-S-007-O	Queued Media Burst cancel request not received by PoC Server. (Controlling PoC Function) PoCv1.0	5.2.1, 5.4, 6.4.4.2.5	POC_UP-MBQ-S-002-O
POC_UP-MBQ-S-008-O	Media Burst request queued -> Queue Statue changes (Grant, Cancel or pre-empt) -> Media Burst Queue Status message sent by PoC Server. (Controlling PoC Function) PoCv1.0	6.4.4.2.5, 6.4.4.3.6, 6.4.5.1.1, 6.4.5.3	POC_UP-MBQ-S-002-O

B.7 Traffic Optimisation (TOP)

B.7.1 PoC Client

Not applicable.

B.7.2 PoC Server

Item	Function	Reference	Requirement
POC_UP-TOP-S-001-O	Support of PoC Media Traffic Optimisation. (Participating PoC Function) PoCv2.0	6.3.5, 7.10	SJR:MSF
POC_UP-TOP-S-002-O	Support of PoC Media Traffic Optimisation. (Controlling PoC Function) PoCv2.0	7.10	SJR:MSF

B.8 Quality of Experience (QoE)

B.8.1 PoC Client

Not applicable.

B.8.2 PoC Server

Item	Function	Reference	Requirement
POC_UP-QOE-S-001-O	When congestion in the PoC Server with a mixture of prioritized and non-prioritized PoC Users/PoC Sessions the PoC Server discards Media packets for non-prioritized PoC Sessions. (Participating PoC Function) PoCv2.0	7.7.2	POC_UP-MBN-S-001-O
POC_UP-QOE-S-002-O	When congestion in the PoC Server with a mixture of prioritized and non-prioritized PoC Users/PoC Sessions the PoC Server discards Media packets for non-prioritized PoC Sessions. (Controlling PoC Function) PoCv2.0	6.4.4.2.2, 6.4.4.3.8, 6.5.2.1, 5.4, 6.5.4.1.6, 6.5.8, 7.7.3	SJR:MSF
POC_UP-QOE-S-003-O	When congestion in the PoC Server with a mixture of prioritized and non-prioritized PoC Users/PoC Sessions the PoC Server discards Media packets for non-prioritized PoC Sessions and releases the PoC Session. (Controlling PoC Function) PoCv2.0	7.7.3	SJR:MSF

B.9 Media Burst Control Scheme (MBC)

B.9.1 PoC Client

Not applicable.

B.9.2 PoC Server

Item	Function	Reference	Requirement
POC_UP-MBN-S-001-O	Support of Media Burst Control Scheme when not queuing Media Burst requests. (Controlling PoC Server) PoCv2.0	7.11	MBN:MSF
POC_UP-MBN-S-002-O	Support of Media Burst Control Scheme when queuing Media Burst requests. (Controlling PoC Server) PoCv2.0	7.11	MBQ:OSF

B.10 PoC Session-related Features (SRF)

B.10.1 PoC Client

Item	Function	Reference	Requirement
POC_UP-SRF-C-001-O	Session modification: Session on hold. PoCv1.0	7.4.1	SJR:MCF OR SJR:OCF
POC_UP-SRF-C-002-O	Support Sender Identification. PoCv1.0	6.2.5.2.2, 6.2.5.2.3, 6.2.5.3.2, 6.2.5.3.6, 6.2.5.5.4, 6.2.5.5.5, 6.2.5.6.3, 6.2.5.6.4, 6.2.6.2.5, 6.2.9.3.2, 6.2.9.3.6, 6.2.9.7.1, 6.2.9.7.2, 6.5.7, 8.2	SJR:MCF OR SJR:OCF
POC_UP-SRF-C-003-O	Support displaying Nick Name. PoCv1.0	6.2.5.2.2, 6.2.5.2.3, 6.2.5.3.2, 6.2.5.3.6, 6.2.5.5.4, 6.2.5.5.5, 6.2.5.6.3, 6.2.5.6.4, 6.2.6.2.5, 6.2.9.3.2, 6.2.9.3.6, 6.2.9.7.1, 6.2.9.7.2, 6.5.7 8.2	SJR:MCF OR SJR:OCF

B.10.2 PoC Server

Item	Function	Reference	Requirement
POC_UP-SRF-S-001-O	Session modification: Session on hold when staying on the Media path. (Participating PoC Function) PoCv1.0	7.4.2	POC_UP-MBN-S-001-O AND POC_UP-SRF-S-002-O
POC_UP-SRF-S-002-O	Support Sender Identification when staying on the Media path. (Participating PoC Function) PoCv1.0	8.3	POC_UP-SRF-S-001-O
POC_UP-SRF-S-003-O	Changes the Nick Name of the Participant who has been permitted to send a Media Burst in the MBCP Media Burst Taken message as specified in [OMA-PoC-CP] "Nick Name" when used and when staying on the Media path. (Participating PoC Function) PoC1.0	8.3	POC_UP-SRF-S-001-O
POC_UP-SRF-S-004-M	Session modification: Session on hold. (Controlling PoC Function) PoCv1.0	7.4.3	
POC_UP-SRF-S-005-O	Sends RTCP SR/RR message to the PoC Client on hold. (Controlling PoC Function) PoCv1.0	7.4.3	

Item	Function	Reference	Requirement
POC_UP-SRF-S-006-M	Support Sender Identification. (Controlling PoC Function) PoCv1.0	8.1, 6.5.7	

B.11 Quality feed back (QFB)

B.11.1 PoC Client

Item	Function	Reference	Requirement
POC_UP-QFB-C-001-O	Support of Quality feed back. PoCv1.0	7.1.2, 7.1.2.1, 7.1.2.2	
POC_UP-QFB-C-002-O	Supports the transmission of RTCP SR/RR compound packets. PoCv1.0	7.1.2	POC_UP-MBN-C-001-O
POC_UP-QFB-C-003-O	Uses the reception of the RTCP SR compound packet as an indication to trigger the transmission of the RTCP RR compound packet. PoCv1.0	7.1.2.2	POC_UP-MBN-C-001-O
POC_UP-QFB-C-004-O	Implements a timer that supervises the reception of the RTCP SR compound packet. PoCv1.0	7.1.2.2	POC_UP-MBN-C-003-O
POC_UP-QFB-C-005-O	Initiates User Plane adaptation. PoCv1.0	7.3.1	
POC_UP-QFB-C-006-O	During the PoC Session, the PoC Client changes the voice frame packetization or voice codec mode by Out-band signalling using SDP payload within SIP messages. PoCv1.0	7.3.1	
POC_UP-QFB-C-007-O	The PoC Client copes with the variable latency in the incoming RTP Media packets to achieve acceptable QoS. PoCv1.0	7.8.1	

B.11.2 PoC Server

Item	Function	Reference	Requirement
POC_UP-QFB-S-001-O	Forwards RTCP compound packets between the PoC Client and the PoC Server performing the Controlling PoC Function acting as a 'translator' according to [RFC3550] for the RTP/RTCP flows. (Participating PoC Function) PoCv1.0	7.1.3	POC_UP-MBN-S-001-O

Item	Function	Reference	Requirement
POC_UP-QFB-S-002-O	Modifies the content of the RTCP SR compound packet send by the PoC Client in an interrupted PoC Session to reflect that the PoC Server has discarded RTP Media packets (if the ongoing Media Burst in a PoC Session was interrupted due to a Media Burst from the another PoC Session). (Participating PoC Function) PoCv1.0	7.1.3	POC_UP-QFB-S-001-O
POC_UP-QFB-S-003-O	Support of Quality feed back. (Controlling PoC Function) PoCv1.0	7.1.1	SJR:MSF
POC_UP-QFB-S-004-O	Generates and sends a RTCP RR compound packet for the Media Burst that it recently received from a PoC Client. (Controlling PoC Function) PoCv1.0	7.1.4	SJR:MSF
POC_UP-QFB-S-005-M	Forwards (and in a Group communication, multiply) the RTCP SR compound packet sent from the PoC Client that transmitted the most recent Media Burst to all other PoC Clients in the PoC Session acting as a 'translator' according to [RFC3550] for the RTP/RTCP flows. (Controlling PoC Function) PoCv1.0	7.1.4	SJR:MSF
POC_UP-QFB-S-006-M	Modifies the content of the RTCP SR compound packets if it is required by the translation, e.g. due to repacketizing. (Controlling PoC Function) PoCv1.0	7.1.4	SJR:MSF
POC_UP-QFB-S-007-O	Acts as a 'monitor' according to [RFC3550] for the RTP flow and use the reported statistics to estimate the current quality of service for fault diagnosis, User Plane adaptation and charging purposes. (Controlling PoC Function) PoCv1.0	7.1.4	SJR:MSF
POC_UP-QFB-S-008-O	Generates and sends a RTCP RR compound packet for the Media Burst that it recently received from a PoC Client. (Controlling PoC Function) PoCv1.0	7.1.4	SJR:MSF
POC_UP-QFB-S-009-O	Initiates User Plane adaptation. (Controlling PoC Function) PoCv1.0	7.3.3	SJR:MSF

Item	Function	Reference	Requirement
POC_UP-QFB-S-010-O	The PoC Server MAY initiate the User Plane adaptation (Media Parameter re-negotiation during a PoC Session) when a new PoC Client with lower Media Parameters enters or leaves the PoC Session. (Controlling PoC Function) PoCv1.0	7.3.3	SJR:MSF
POC_UP-QFB-S-011-O	When determining the Media Parameters the PoC Server takes into account the highest common Media Parameters provided by both the new and the existing Participants in the PoC Session. (Controlling PoC Function) PoCv1.0	7.3.3	SJR:MSF

B.12 Invited parties identity information (IPI)

B.12.1 PoC Client

Item	Function	Reference	Requirement
POC_UP-IPI-C-001-O	Support of invited parties identity information. PoCv2.0	6.5.13	POC_UP-SJR-C-001-O

B.12.2 PoC Server

Item	Function	Reference	Requirement
POC_UP-IPI-S-001-O	Support of invited parties identity information. (Participating PoC Function) PoCv2.0	6.5.13	POC_UP-SJR-S-001-O

B.13 Backwards compatibility (XBC)

This subclause describes the SCRs for functions needed to support backwards compatibility.

B.13.1 PoC Client

Item	Function	Reference	Requirement
POC_UP-XBC-C-001-M	PoC Client support of backwards compatibility with earlier versions of PoC UP. PoCv2.0	[OMA-PoC-AD] 5.2	[OMA-PoC-1-UP]:MCF
POC_UP-XBC-C-001-O	PoC Client support of backwards compatibility with earlier versions of PoC UP. PoCv2.0	[OMA-PoC-AD] 5.2	[OMA-PoC-1-UP]:OCF

B.13.2 PoC Server

Item	Function	Reference	Requirement
PoC_UP-XBC-S-001-M	PoC Server support of backwards compatibility with earlier versions of PoC UP. PoCv2.0	[OMA-PoC-AD] 5.2	[OMA-PoC-1-UP]:MSF

Appendix C. Message flows (Informative)

This Annex shows some examples of MBCP message and Quality feedback message flows.

The PoC Client and the PoC Server performing the Controlling PoC Function and the PoC Server performing the Participating PoC Function are supporting the following Media Burst Control procedures, which are shown as example flows in the following subclauses:

- Media Burst request at PoC Session initialization;
- Media Burst idle procedure;
- Media Burst request during a PoC Session;
- Media Burst revoke procedure;
- Media Burst release procedure;
- Quality feedback flows;
- Sender Identification flow; and,
- PoC Session release in the Pre-established Session case.

C.1 Media Burst request at PoC Session initialization

A PoC Session is established as specified in the [OMA-PoC-CP].

As stated in subclause 6.4.2 "*Controlling PoC Function procedures at PoC Session initialization*" the PoC Server performing the Controlling PoC Function interprets the initial SIP INVITE request (in case of an On-demand Session) or the SIP REFER request (in case of an Pre-established Session) as an implicit Media Burst request.

C.1.1 Message flows in the originating PoC network

C.1.1.1 Media Burst request procedure at PoC Session establishment – On-demand Session case

This subclause describes what happens when a PoC User initiates a PoC Session using an On-demand Session.

Figure 15 "*Media Burst request procedure at PoC Session establishment – On-demand Session case*" shows the message flow for the scenario.

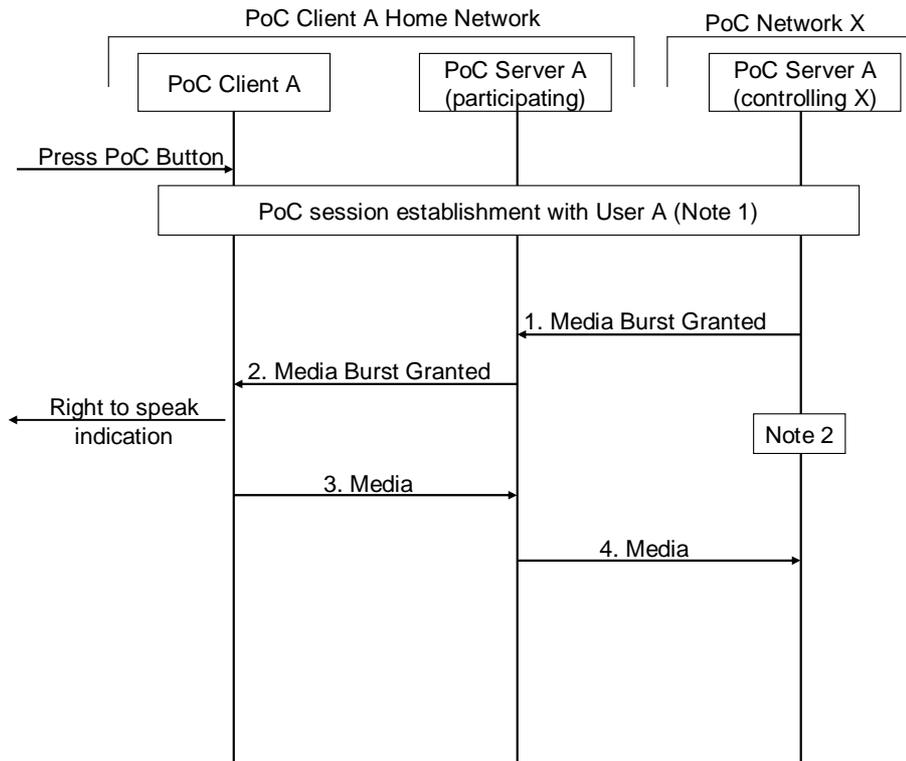

NOTE 1: The PoC Session establishment is an On-demand Session (initiated by a SIP INVITE request). While this scenario shows the MBCP Media Burst Granted message being sent after the PoC Session is established, the MBCP Media Burst Granted message can be transmitted before or during the PoC Session establishment depending on whether the PoC Session establishment is confirmed or unconfirmed.

NOTE 2: For MBCP message flow for Invited PoC Users see Figure 22 "Inviting a PoC User to a PoC Session using On-demand Session establishment".

Figure 15: Media Burst request procedure at PoC Session establishment – On-demand Session case

A PoC User A at a PoC Client A has pressed the PoC button and the PoC Client A has initiated a PoC Session with a PoC Server X (controlling). This creates an implicit MBCP Media Burst Request message at the PoC Server X (controlling).

A PoC Server A (participating) has inserted itself in the Media Stream and all MBCP messages and RTP Media packets will go thru the PoC Server A (participating).

The steps of the flow are as follows:

1. The PoC Server X (controlling) sends a MBCP Media Burst Granted message towards the PoC Client.
2. The PoC Server A (participating) modifies the IP address and port and sends the MBCP Media Burst Granted message to PoC Client A.
3. When PoC Client A receives the MBCP Media Burst Granted message, the PoC Client provides a Media Burst granted notification, including information about the stop talking timer, to the PoC User A. The PoC Client A then begins to send RTP Media packets towards the PoC Server X (controlling).
4. PoC Server (participating) A modifies the IP address and port and forwards the RTP Media packet to PoC Server X (controlling).

C.1.1.2 Media Burst request procedure at PoC Session establishment – Pre-established Session case

This subclause describes what happens when a PoC User initiates a PoC Session using Pre-established Session.

Figure 16 "Media Burst request procedure at PoC Session establishment- Pre-established Session case" shows the message flow for the scenario.

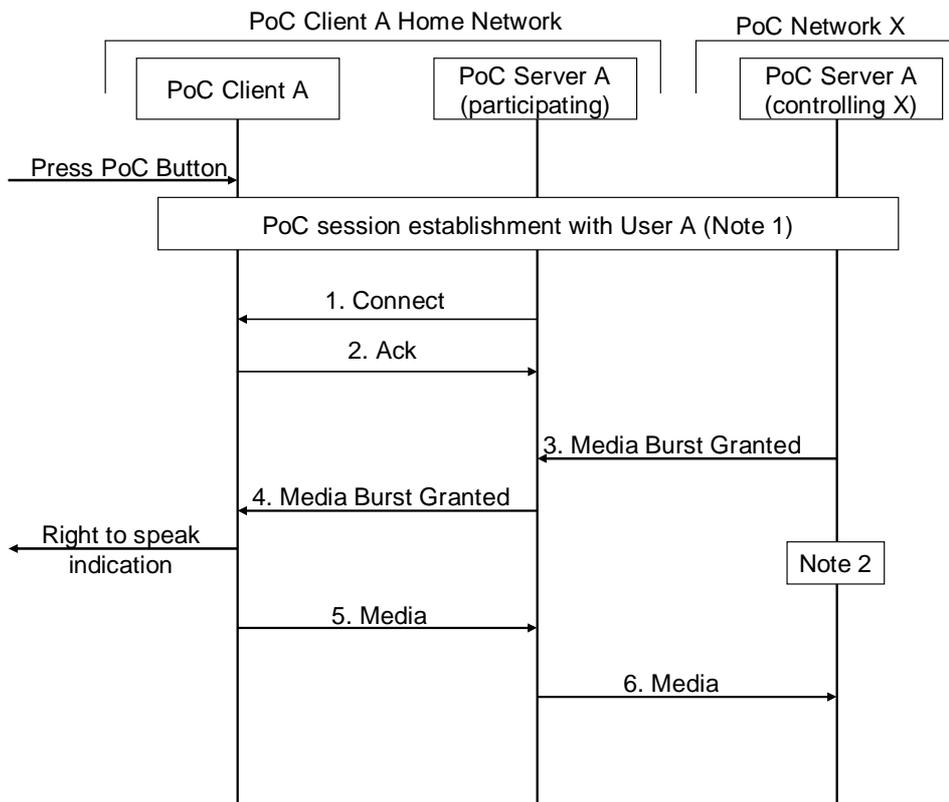

NOTE 1: The PoC Session is established over a Pre-established Session (initiated by a SIP REFER request). While this scenario shows the MBCP Media Burst Granted message being sent after the PoC Session is established, the MBCP Media Burst Granted message can be transmitted before or during the PoC Session establishment depending on whether the PoC Session establishment is confirmed or unconfirmed.

NOTE 2: For MBCP message flow for Invited PoC Users see Figure 23 "Inviting a PoC User to a PoC Session using Pre-established Session establishment".

Figure 16: Media Burst request procedure at PoC Session establishment – Pre-established Session case

A PoC User A at a PoC Client A has pressed the PoC button and the PoC Client A has initiated a PoC Session with a PoC Server X (controlling). This creates an implicit MBCP Media Burst Request message at the PoC Server X (controlling).

A PoC Server A (participating) has inserted itself in the Media Stream and all MBCP messages and RTP Media packets will go thru the PoC Server A (participating).

The steps of the flow are as follows:

1. The PoC Server A (participating) sends the MBCP Connect message to the PoC Client A to indicate the PoC Session establishment and to indicate the PoC Session Identity.

2. The PoC Client A sends MBCP Media Burst Acknowledgment to acknowledge the MBCP Connect.
3. The PoC Server X (controlling) sends a MBCP Media Burst Granted message, including information about the T2 (Stop talking) timer, to the PoC Client.

NOTE: MBCP Messages MBCP Connect and MBCP Media Burst Granted can be sent in the same IP message.

4. When PoC Client A receives the MBCP Media Burst Granted message, the PoC Client provides a Media Burst granted notification, including information about the stop talking timer, to the PoC User A. The PoC Client A then begins to send RTP Media packets towards the PoC Server X (controlling).
5. PoC Server (participating) A modifies the IP address and port and forwards the RTP Media packet to PoC Server X (controlling).

C.1.1.3 A PoC User joins a PoC Group during an ongoing Media Burst

This subclause describes what happens when a PoC User joins a PoC Group communication during an ongoing Media Burst.

Figure 17 "A PoC User joins a PoC Group during an ongoing Media Burst" shows the message flow for the scenario.

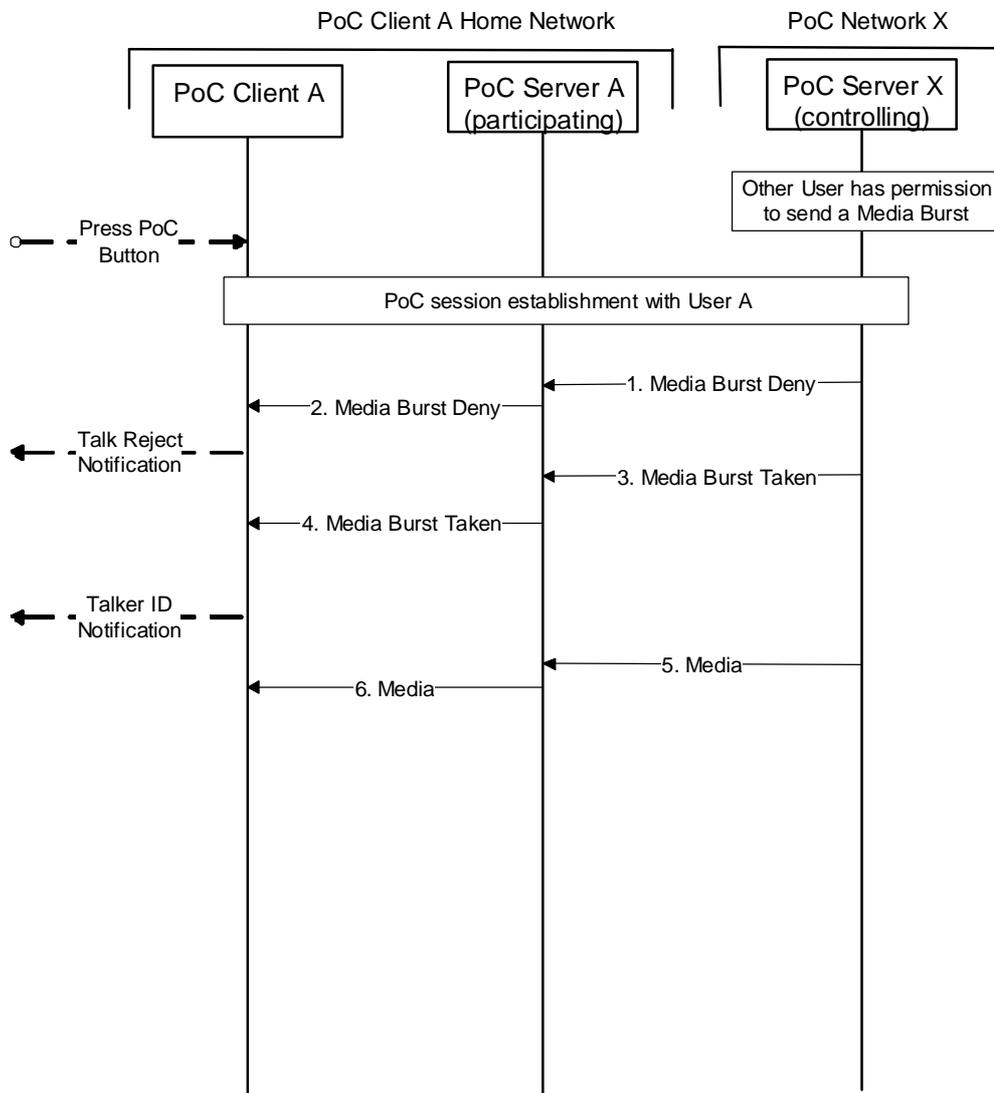

NOTE: The PoC Session can be an On-demand Session (initiated by a SIP INVITE request) or a PoC Session over a Pre-established Session (initiated by a SIP REFER request).

Figure 17: A PoC User joins a PoC Group during an ongoing Media Burst

The PoC User at a PoC Client A has pressed the PoC button and the PoC Client A has initiated a PoC Session with a PoC Server X (controlling). This creates an implicit MBCP Media Burst Request message at the PoC Server X (controlling).

A PoC Server A (participating) has inserted itself in the Media Stream and all MBCP messages and RTP Media packets will go thru the PoC Server A (participating).

The steps of the flow are as follows:

1. The PoC Server X (controlling) sends a MBCP Media Burst Deny message towards the PoC Client A.
2. The PoC Server A (participating) modifies the IP address and port and sends the MBCP Media Burst Deny message to PoC Client A. The PoC Client A sends a Media Burst deny notification to the PoC User A.

3. The PoC Server X (controlling) sends the MBCP Media Burst Taken message to the PoC Client A. The message includes the identity of the PoC User that currently has permission to send a Media Burst.

NOTE: The MBCP Media Burst Deny message and MBCP Media Burst Taken message can be sent in the same IP packet.

4. The PoC Server A (participating) modifies the IP address and port and sends the MBCP Media Burst Taken message to PoC Client A. PoC Client A presents the Sender Identification to the PoC User A.
5. The PoC Server X (controlling) begins to transmit RTP Media packets towards PoC Client A.
6. PoC Server A (participating) modifies the IP address and port of the RTP Media packet and sends the RTP Media packet to PoC Client A. The PoC Client A plays the Media to the PoC User A.

C.1.1.4 PoC User releases PoC button before the PoC Session establishment is completed

This subclause shows an example of when a PoC User wishes to start a PoC Session receiving Media, instead of sending Media.

Figure 18 "*PoC User releases PoC button before the PoC Session establishment is completed*" shows the message flow for the scenario.

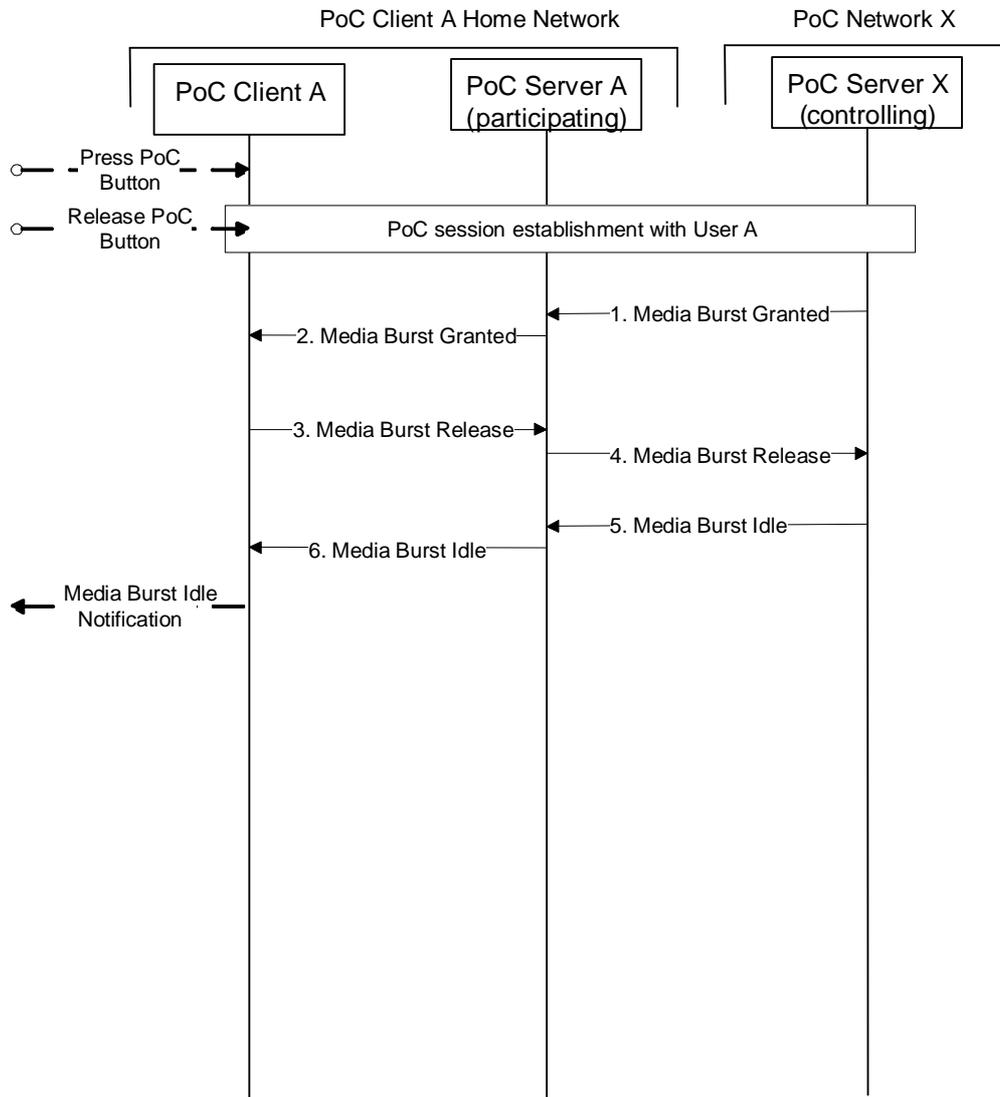

NOTE 1: The PoC Session can be an On-demand Session (initiated by a SIP INVITE request) or a PoC Session over a Pre-established Session (initiated by a SIP REFER request).

NOTE 2: While this scenario shows the MBCP Media Burst Granted message being sent after the PoC Session is established, the MBCP Media Burst Granted message can be transmitted before or during the PoC Session establishment depending on whether the PoC Session establishment is confirmed or unconfirmed.

Figure 18: PoC User releases PoC button before the PoC Session establishment is completed

A PoC User A at a PoC Client A has pressed the PoC button and the PoC Client A has initiated a PoC Session with the PoC Server X (controlling). This creates an implicit MBCP Media Burst Request message at the PoC Server X (controlling). The PoC Server X (controlling) grants the PoC Client A the permission to send a Media Burst when the PoC User A releases the PoC button.

A PoC Server A (participating) has inserted itself in the Media Stream and all MBCP messages and RTP Media packets will go thru the PoC Server A (participating).

The steps of the flow are as follows:

1. The PoC Server X (controlling) sends a MBCP Media Burst Granted message, including information about the stop talking timer, towards the PoC Client A.
2. The PoC Server A (participating) modifies the IP address and port and sends the message to PoC Client A.
3. When the PoC Client A receives the MBCP Media Burst Granted message, the PoC Client immediately sends a MBCP Media Burst Release message towards the PoC Server X (controlling).
4. The PoC Server A (participating) modifies the IP address and port and sends the MBCP Media Burst Release message to the PoC Server X (controlling).
5. The PoC Server X (controlling) sends a MBCP Media Burst Idle message towards all PoC Clients connected to the PoC Session.
6. The PoC Server A (participating) modifies the IP address and port and sends the MBCP Media Burst Idle message to PoC Client A.

C.1.1.5 PoC Session establishment failure – Pre-established Session case

This subclause describes what happens when a PoC User initiates a PoC Session using Pre-established Session and the PoC Server refuses the PoC Session.

Figure 19 "PoC Session establishment is rejected - Pre-established Session case" shows the message flow for the scenario.

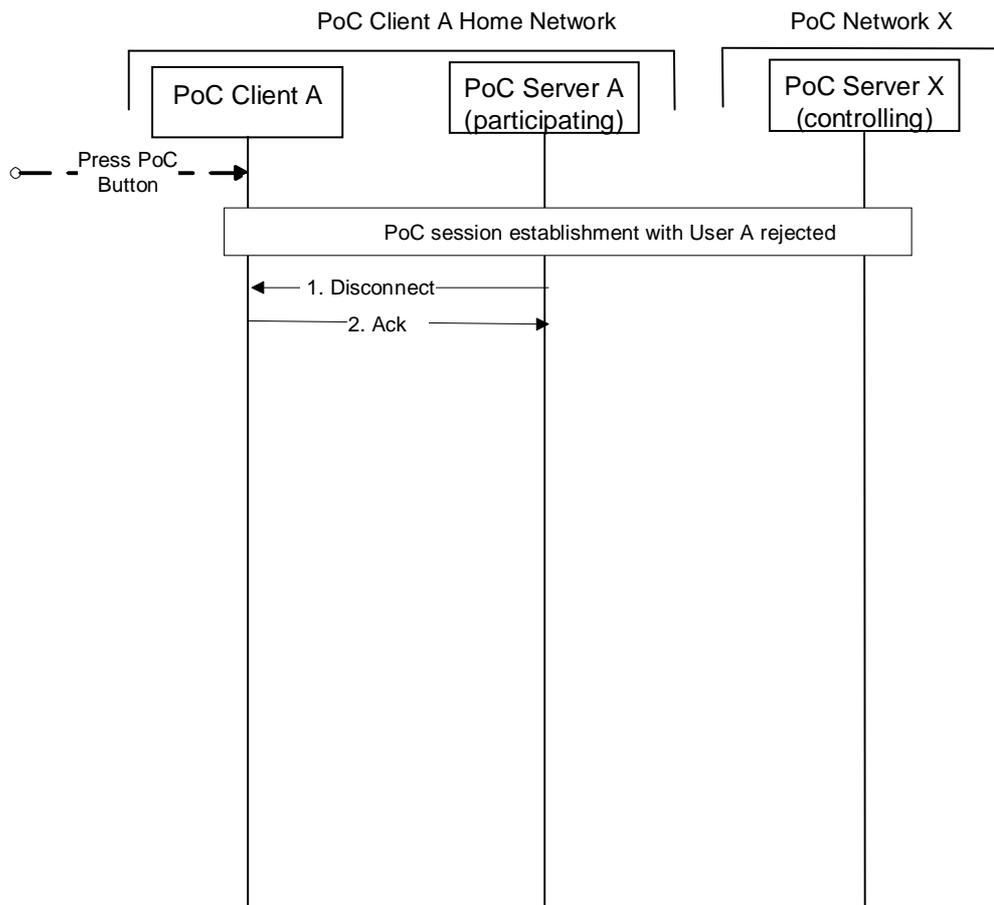

Figure 19: PoC Session establishment is rejected – Pre-established Session case

A PoC User A at a PoC Client A has pressed the PoC button and the PoC Client A has initiated a PoC Session with a PoC Server X (controlling). This creates an implicit MBCP Media Burst Request message at the PoC Server X (controlling).

The Controlling PoC Server has rejected the PoC Session.

The steps of the flow are as follows:

1. The PoC Server A (participating) receives a failed indication from PoC Server X (controlling) and sends the MBCP Disconnect message to the PoC Client A to indicate the PoC Session establishment is rejected.
2. The PoC Client A sends MBCP Media Burst Acknowledgment to acknowledge the MBCP Disconnect message.

C.1.1.6 PoC Session establishment– Limited Segment Media Buffer Preload Capability is used

This subclause describes what happens when a PoC User initiates a PoC Session using On-Demand Session and Limited Segment Media Buffer preload capability is used.

Figure 20 "*PoC Session establishment– Limited Segment Preload Capability is used*" shows the message flow for the scenario.

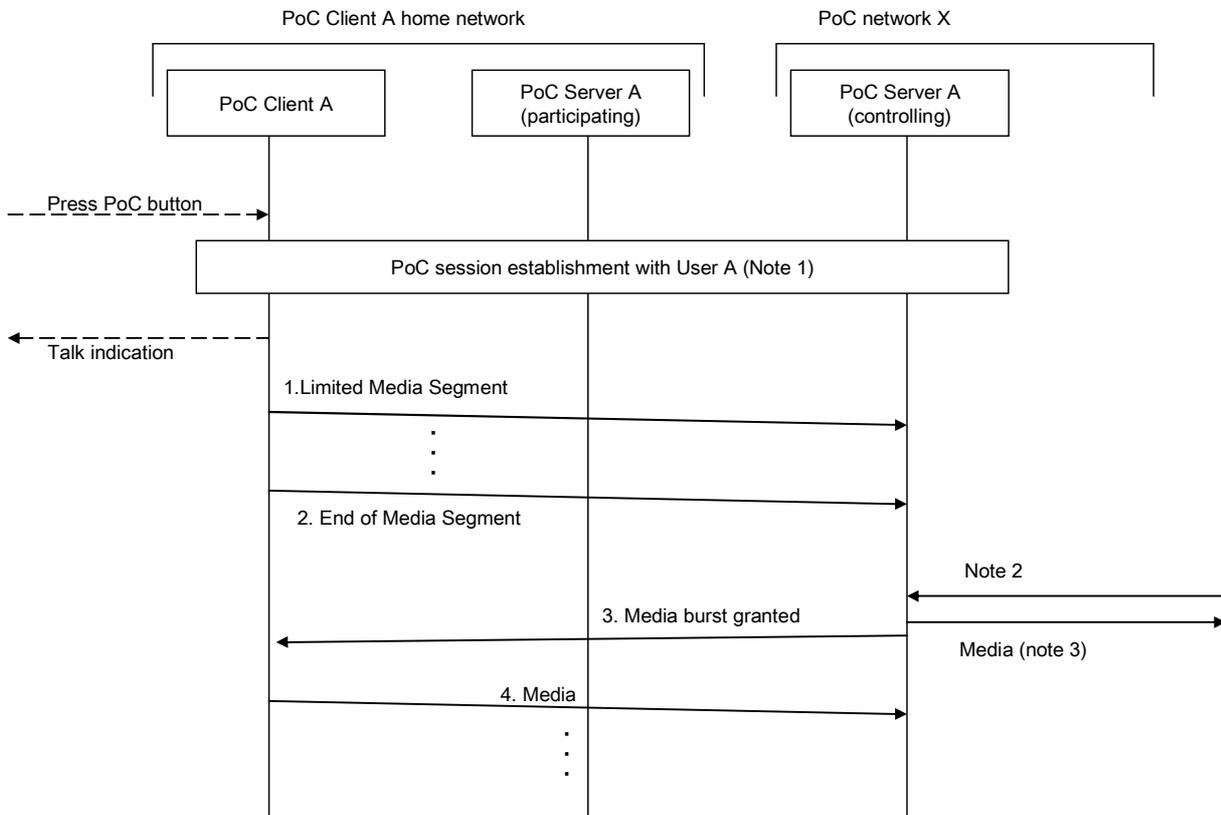

NOTE 1: The PoC Session establishment is an On-demand Session (initiated by a SIP INVITE request) and both PoC Client and PoC Server performing the Controlling PoC Function support Limited Segment Media Buffer Preload capability. The PoC Session establishment with User A is on the basis of Unconfirmed Indication, as defined in [OMA-PoC-CP].

NOTE 2: In the case illustrated, an Invited PoC Client provides a Confirmed Indication as defined in [OMA-PoC-CP].

Figure 20: PoC Session establishment– Limited Segment Preload Capability is used

A PoC User A at a PoC Client A has pressed the PoC button and the PoC Client A has initiated a PoC Session with a PoC Server X (controlling), and a talk indication is given to the User. This creates an implicit MBCP Media Burst Request message at the PoC Server X (controlling).

A PoC Server A (participating) has not inserted itself in the Media Stream and all MBCP messages and RTP Media packets will go directly to PoC Server X (controlling).

The steps of the flow are as follows:

1. After the PoC button is pressed an indication is given to the User and the PoC Client A begins to send a limited segment of RTP Media packets towards the PoC Server X (controlling).

2. The PoC Client A finishes sending a limited segment of RTP Media packets towards the PoC Server X (controlling).
3. The PoC Server X (controlling) sends a MBCP Media Burst Granted message towards the PoC Client.

NOTE: After receiving Confirmed Indication the PoC Server (controlling) also starts to send Media to Invited PoC Client(s). For MBCP message flow for Invited PoC Users see Figure 22 "Inviting a PoC User to a PoC Session using On-demand Session establishment".

4. When PoC Client A receives the MBCP Media Burst Granted message, the PoC Client A then begins to send remaining RTP Media packets towards the PoC Server X (controlling).

C.1.2 Media Burst Granted message from PoC Server performing the Controlling PoC Function is lost

This subclause shows an example of the scenario when the MBCP Media Burst Granted message, sent from the PoC Server performing the Controlling PoC Function during PoC Session establishment, is lost.

Figure 21 "MBCP Media Burst Granted message from PoC Server performing the Controlling PoC Function is lost" shows the message flow for the scenario.

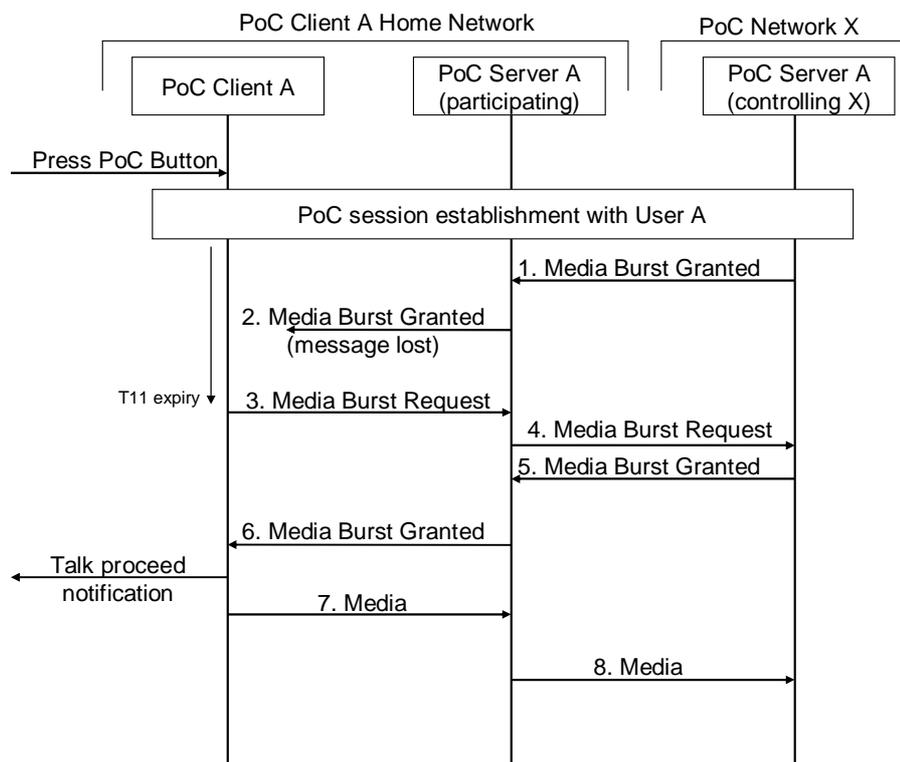

NOTE: The PoC Session can be an On-demand Session (initiated by a SIP INVITE request) or a PoC Session over a Pre-established Session (initiated by a SIP REFER request). While this scenario shows the MBCP Media Burst Granted message being sent after the PoC Session is established, the MBCP Media Burst Granted message can be transmitted before or during the PoC Session establishment depending on whether the PoC Session establishment is confirmed or unconfirmed.

Figure 21: MBCP Media Burst Granted message from PoC Server performing the Controlling PoC Function is lost

A PoC User A at a PoC Client A has pressed the PoC button and the PoC Client A has initiated a PoC Session with a PoC Server X (controlling). This creates an implicit MBCP Media Burst Request message at the PoC Server X (controlling). The

PoC Server X (controlling) grants the PoC Client to send one Media Burst but the PoC Client A does not receive the message.

The PoC Client is supervising the reception of a MBCP message (e.g. the MBCP Media Burst Granted message) by means of the timer T11 (Media Burst Request).

A PoC Server A (participating) has inserted itself in the Media Stream and all MBCP messages and RTP Media packets will go thru the PoC Server A (participating).

The steps of the flow are as follows:

1. When the PoC Server X (controlling) receives the PoC Session Initiation from PoC Client A, an implicit Media Burst request is created at the PoC Server X (controlling). The PoC Server X (controlling) then sends a MBCP Media Burst Granted message, including information about the stop talking timer, towards the PoC Client A.
2. The PoC Server A (participating) modifies the IP address and port and tries to send the MBCP Media Burst Granted message to PoC Client A. During transmission the message gets lost.
3. When the T11 (Media Burst Request) timer expires in the PoC Client A, the PoC Client sends a MBCP Media Burst Request message towards the PoC Server X (controlling).
4. The PoC Server A (participating) modifies the IP address and port and sends the MBCP Media Burst Request message to the PoC Server X (controlling). When the PoC Server (controlling) receives the MBCP Media Burst Request message, the PoC Server sends the same response to the PoC Client A that previously sent.
5. When the PoC Server X (controlling) receives the MBCP Media Burst Request message, the PoC Server sends the same response to the PoC Client A previously sent in step 1.
6. The PoC Server A (participating) modifies the IP address and port and sends the MBCP Media Burst Granted message to PoC Client A.
7. When PoC Client A receives the MBCP Media Burst Granted message, the PoC Client provides a Media Burst granted notification, including information about the stop talking timer, to the User A. PoC Client A then begins to send RTP Media packets towards the PoC Server X (controlling).
8. PoC Server (participating) A modifies the IP address and port and forwards the RTP Media packet to PoC Server X (controlling).

C.1.3 Message flows in the terminating PoC network

C.1.3.1 Inviting a PoC User to a PoC Session using On-demand Session establishment

This subclause shows an example of the scenario when a PoC User is invited to a PoC Session using On-demand Session establishment.

Figure 22 "*Inviting a PoC User to a PoC Session using On-demand Session establishment*" shows the message flow for the scenario.

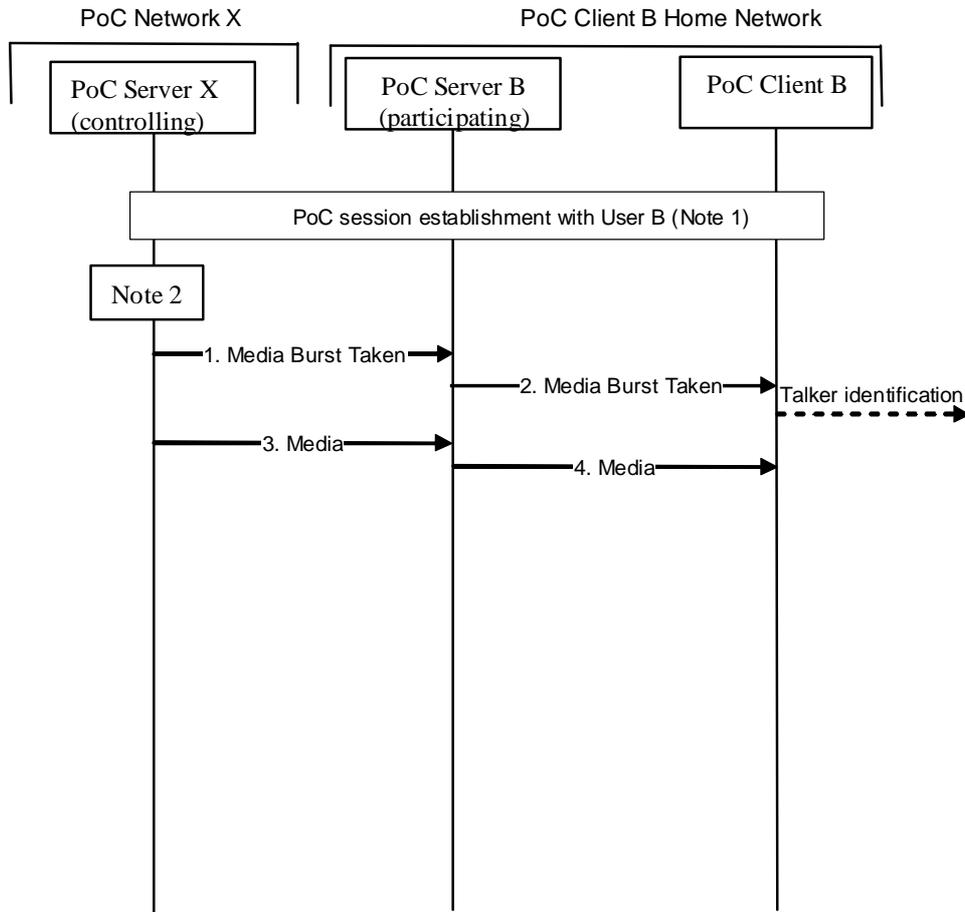

NOTE 1: While only 1 terminating PoC Client B is shown in the figure, this flow applies to all terminating PoC Clients where On-demand establishment is used for Inviting PoC Users to a PoC Session.

NOTE 2: The MBCP message flows for the Inviting PoC User see Figure 15 "*Media Burst request procedure at PoC Session establishment*".

Figure 22: Inviting a PoC User to a PoC Session using On-demand Session establishment

A PoC Session is established with an Invited PoC User B at the PoC Client B and a PoC Server X (controlling). The normal case results in that the Invited PoC Client has no permission to send a Media Burst.

A PoC Server B (participating) has inserted itself in the Media Stream and all MBCP messages and RTP Media packets will go thru the PoC Server B (participating).

The steps of the flow are as follows:

1. A PoC Server X (controlling) sends a MBCP Media Burst Taken message towards the PoC Client B. The message includes the identity of the PoC User that currently has permission to send a Media Burst.
2. The PoC Server B (participating) modifies the IP address and port and sends the MBCP Media Burst Taken message to PoC Client B. The PoC Client B presents the senders identity to PoC User B.
3. The PoC Server X (controlling) begins to transmit RTP Media packets towards the PoC Client B.

- The PoC Server A modifies the IP address and port of the RTP Media packet and sends the RTP Media packet to the PoC Client B. The PoC Client B plays the Media to the PoC User B.

C.1.3.2 Inviting a PoC User to a PoC Session using a Pre-established Session

This subclause shows an example of the scenario when a PoC User is invited to a PoC Session using a Pre-established Session.

Figure 23 "Inviting a PoC User to a PoC Session using a Pre-established Session" shows the message flow for the scenario.

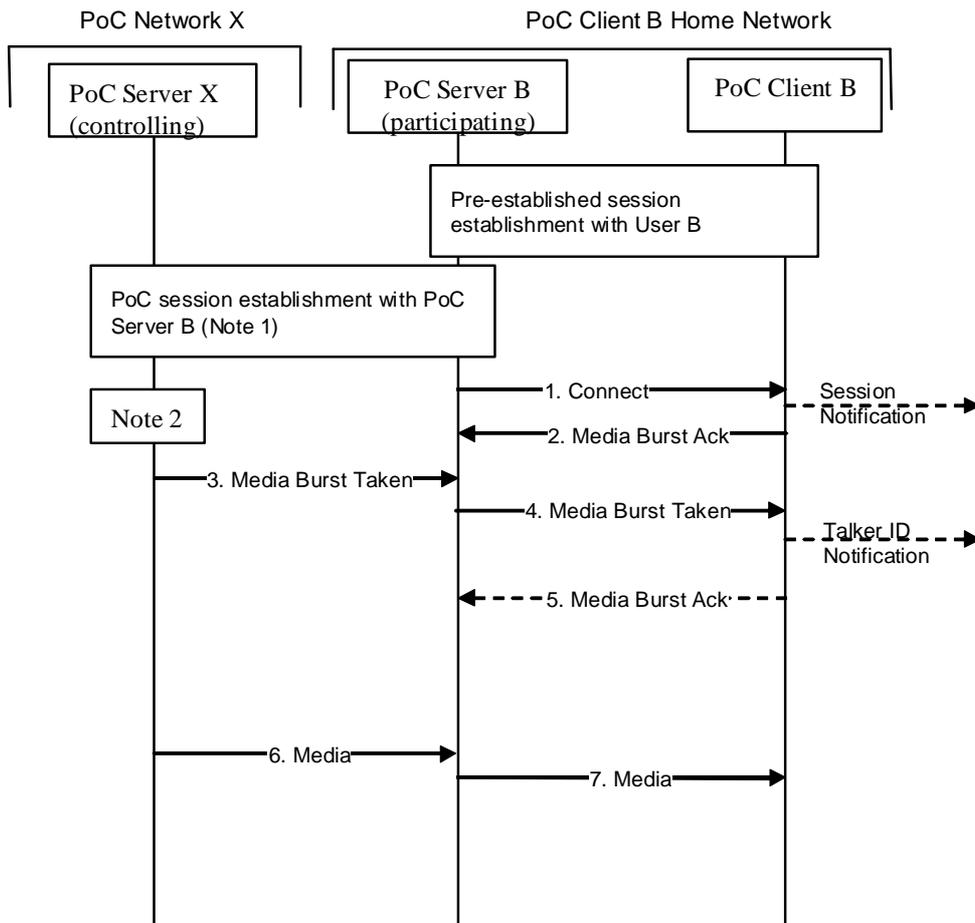

NOTE 1: While only 1 terminating PoC Client B is shown in the figure, this flow applies towards all terminating PoC Clients with a Pre-established Session invited to a PoC Session.

NOTE 2: The MBCP message flow for the Inviting PoC User see Figure 15 "Media Burst request procedure at PoC Session establishment".

Figure 23: Inviting a PoC User to a PoC Session using a Pre-established Session

A PoC Server B (participating) controls the Pre-established Session and all MBCP messages and RTP Media packets will go thru the PoC Server B (participating).

The steps of the flow are as follows:

1. The PoC Server B (participating) sends a MBCP Connect message to PoC Client B triggered by the SIP INVITE. The message includes the identity of the PoC User that initiated the PoC Session. The PoC Server B (participating) adds the identity of the PoC Group. The PoC Client B presents the Group Identity, if exists, to PoC User B.
2. The PoC Client B sends a MBCP Media Burst Acknowledgement message to PoC Server B (participating) to acknowledge the receipt of the MBCP Connect message.
3. The PoC Server X (controlling) sends a MBCP Media Burst Taken message to PoC Client B. The MBCP Media Burst Taken message includes the identity of the PoC User that currently has the permission to send a Media Burst.
4. The PoC Server B (participating) modifies the IP address and port and sends the MBCP Media Burst Taken message to PoC Client B.
5. The PoC Client B sends a MBCP Media Burst Acknowledgement message to Participating PoC Server B to acknowledge the receipt of the MBCP Media Burst Taken message, if requested.
6. Controlling PoC Server X begins to transmit RTP Media packets to the PoC Client B. While this is shown as beginning after the receipt of the MBCP Media Burst Acknowledgement message in this flow, the transmission of the RTP Media packets can begin at any time after the MBCP Media Burst Taken message has been sent.
7. The PoC Server A (participating) modifies the IP address and port of the RTP Media packet and sends the RTP Media packet to the PoC Client B.

C.2 Media Burst idle procedure

This subclause shows the scenario when another PoC Client has completed the sending of a Media Burst or if another PoC Client was revoked the permission to send a Media Burst.

Figure 24 "Media Burst idle procedure" shows the message flow for the scenario.

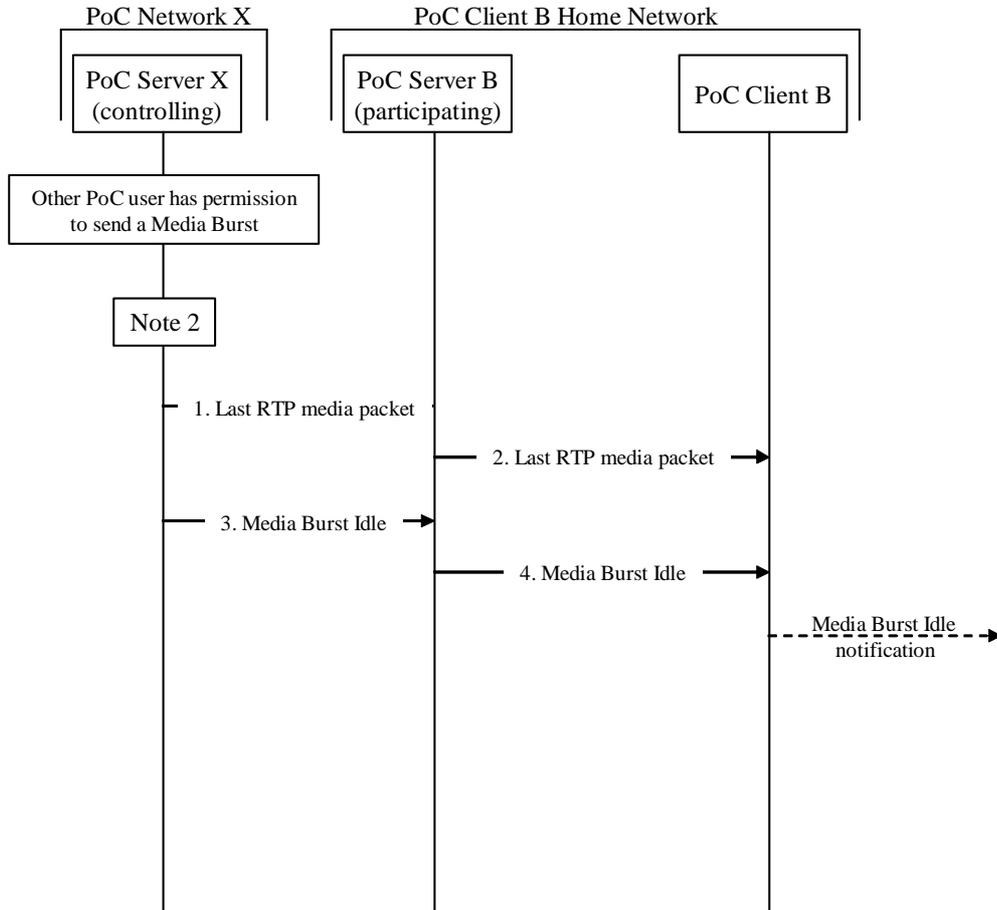

NOTE 1: While only 1 terminating PoC Client B is shown in the figure, this flow applies towards all receiving PoC Clients in a PoC Session.

NOTE 2: For the MBP message flows when the PoC User releases the PoC button, see Figure 26 "MBP Media Burst Release procedure", Figure 29 "Media Burst Revoke procedure in PoC Server performing the Controlling PoC Function" and Figure 30 "Media Burst release procedure".

Figure 24: Media Burst idle procedure

The PoC Server X (controlling) has received a MBP Media Burst Release message from the PoC Client that has been given permission to send a Media Burst.

A PoC Server B (participating) has inserted itself in the Media Stream and all MBP messages and RTP Media packet will go thru the PoC Server B (participating).

The steps of the flow are as follows:

1. The last RTP Media packet is sent from PoC Server X (controlling) towards all the PoC Clients in the PoC Session, including the PoC Client B.
2. The PoC Server B (participating) modifies the IP address and port of the last RTP packet and sends the packet to the PoC Client B.
3. The PoC Server X (controlling) sends a MBCP Media Burst Idle message to all PoC Clients in the PoC Session, including the PoC Client B.
4. The PoC Server B (participating) modifies the IP address and port and sends the message to PoC Client B. PoC Client B sends a Media Burst idle notification to PoC User B.

C.3 Media Burst request during a PoC Session

C.3.1 Sending a Media Burst request

This subclause shows the normal case when the PoC Client has received a MBCP Media Burst Idle message from the PoC Server performing the Controlling PoC Function and the PoC User at the PoC Client presses the PoC button in order to request permission to send a Media Burst.

Figure 25 "*Another PoC User request the permission to send a Media Burst*" shows the message flow for the scenario.

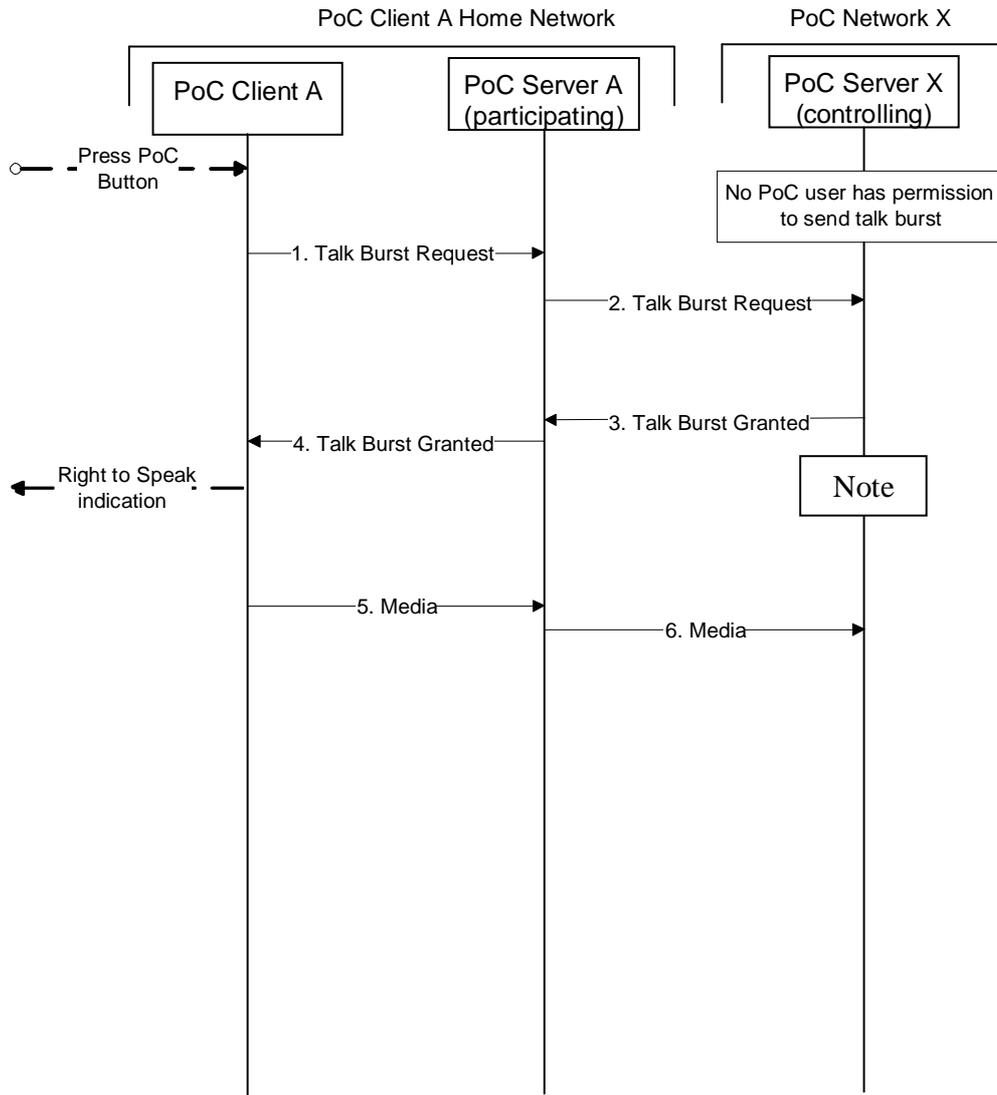

NOTE: For the MBCP message flows for PoC Users without permission to talk see Figure 27 "Another PoC User request the permission to send a Media Burst".

Figure 25: Sending a Media Burst request

A PoC User A at the PoC Client A presses the PoC button.

A PoC Server A (participating) has inserted itself in the Media Stream and all MBCP messages and RTP Media packet will go thru the PoC Server A (participating).

The steps of the flow are as follows:

1. The PoC Client A sends a MBCP Media Burst Request message towards the PoC Server X (controlling).
2. The PoC Server A (participating) modifies the IP address and port and sends the MBCP Media Burst Request message to PoC Server X (controlling).

3. The PoC Server X (controlling) determines that the PoC Client A can be given permission to send a Media Burst and sends a MBTCP Media Burst Granted message, including information about the stop talking timer, towards the PoC Client A.
4. The PoC Server A (participating) modifies the IP address and port and sends the MBTCP Media Burst Request message to the PoC Client A.
5. When the PoC Client A receives the MBTCP Media Burst Granted message, the PoC Client provides a Media Burst granted notification, including information about the stop talking timer, to the PoC User A. The PoC Client A then begins to send RTP Media packets towards the PoC Server X (controlling).
6. The PoC Server A (participating) modifies the IP address and port and forwards the RTP Media packets to the PoC Server X (controlling).

C.3.2 Media Burst request when other PoC User has the permission to send a Media Burst and queuing is not supported

This subclause describes the case when a PoC User request for permission to send a Media Burst when another PoC User already has the permission and queuing is not supported.

Figure 26 "*MBTCP Media Burst Request message when other PoC User has the permission to send a Media Burst*" shows the message flow for the scenario.

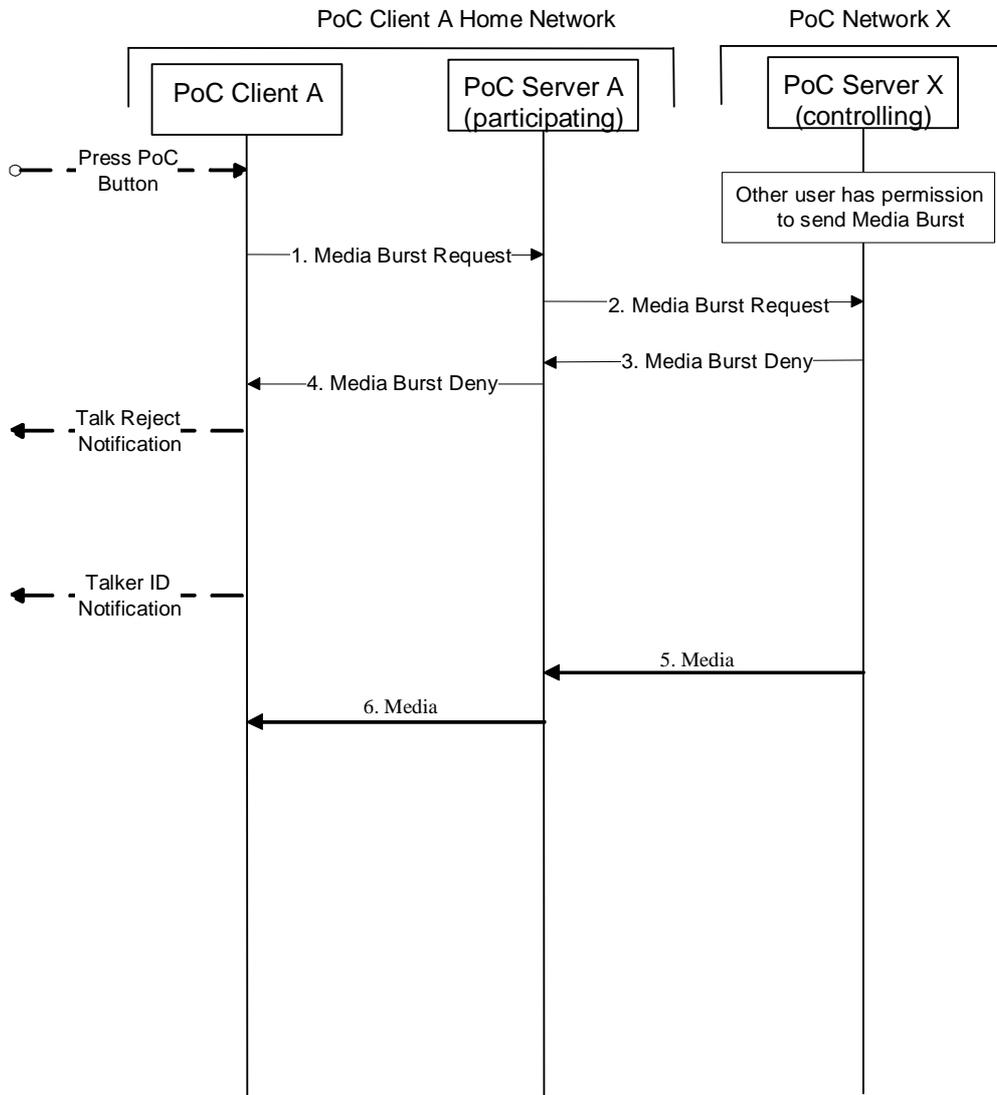

NOTE: The MBCP Media Burst Deny message and the MBCP Media Burst Taken message can be sent in the same IP packet.

Figure 26: MBCP Media Burst Request message when other PoC User has the permission to send a Media Burst

A PoC User A at a PoC Client A presses the PoC button.

A PoC Server A (participating) has inserted itself in the Media Stream and all MBCP messages and RTP Media packets will go thru the PoC Server A (participating).

The steps of the flow are as follows:

1. The PoC Client A sends a MBCP Media Burst Request message towards a PoC Server X (controlling).
2. The PoC Server A (participating) modifies the IP address and port and sends the MBCP Media Burst Request message to the PoC Server X (controlling).

3. The PoC Server X (controlling) determines that the PoC Client A cannot be given permission to send a Media Burst, because another PoC Client currently has permission and sends a MBCP Media Burst Deny message towards the PoC Client A. The message includes:
 - a. A reason code (Another PoC User has permission) for the rejection.
4. The PoC Server A (participating) modifies the IP address and port and sends the MBCP Media Burst Deny message to PoC Client A.
5. The PoC Server X (controlling) begins to transmit RTP Media packets towards PoC Client A.
6. The PoC Server A (participating) modifies the IP address and port and sends the RTP Media packets to PoC Client A. The PoC Client A plays the Media to PoC User A.

C.3.3 Another PoC User request the permission to send a Media Burst

This subclause shows an example of the case when another PoC Client is granted permission to send a Media Burst.

Figure 27 "Another PoC User request the permission to send a Media Burst" shows the message flow for the scenario.

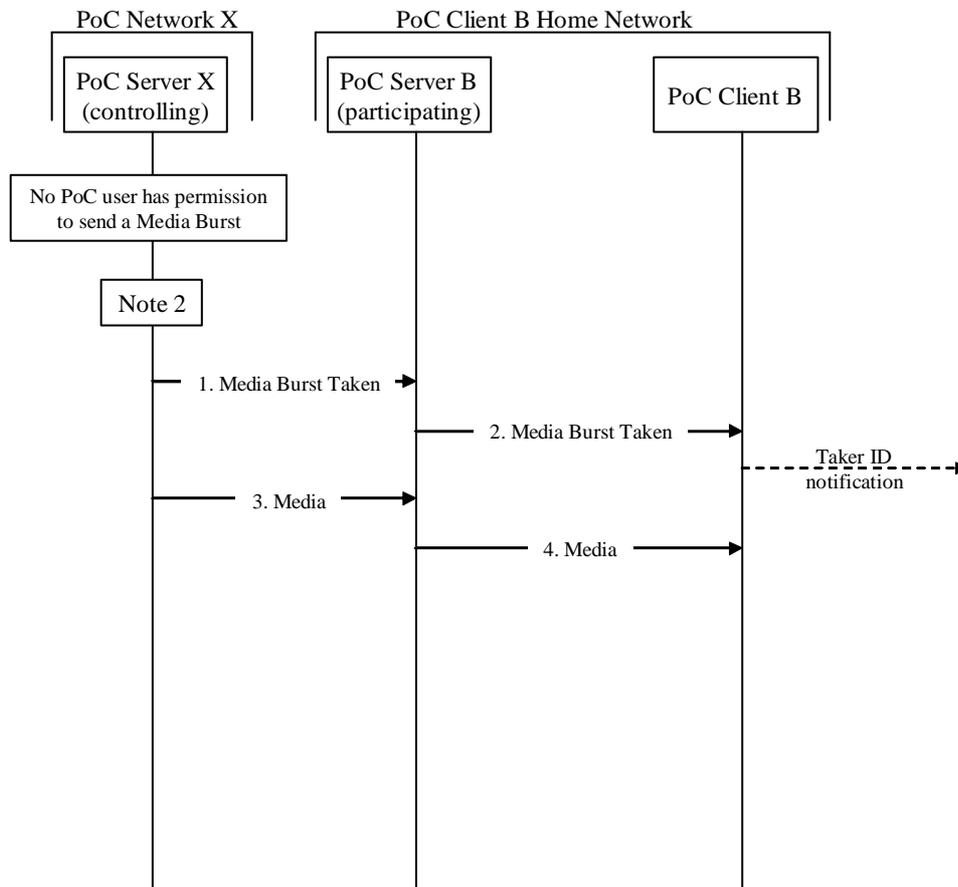

NOTE 1: The PoC Server X (controlling) executes this procedure for all PoC Clients that will be receiving.

NOTE 2: For the MBCP message flows for the granted PoC User see Figure 25 "Sending a Media Burst request".

Figure 27: Another PoC User request the permission to send a Media Burst

This procedure starts when no PoC Client has the permission to send a Media Burst. Prior to the start of the message flow another PoC Client has sent a MBCP Media Burst Request message to the PoC Server X (controlling) and the PoC Server has granted that PoC Client permission to send a Media Burst.

A PoC Server B (participating) has inserted itself in the Media Stream and all MBCP messages and RTP Media packet will go thru the PoC Server B (participating).

The steps of the flow are as follows:

1. The PoC Server X (controlling) sends a MBCP Media Burst Taken message towards PoC Client B. The message includes:
 - a. The identity of the PoC User that currently has the permission to send the Media Burst.
2. The PoC Server B (participating) modifies the IP address and port and sends the message to the PoC Client B. The PoC Client B presents the Sender Identification to the PoC User B.
3. The PoC Server X (controlling) begins to transmit RTP Media packet towards the PoC Client B.
4. The PoC Server B (participating) modifies the IP address and port of the RTP Media packet and sends the RTP Media packet to PoC Client B. The PoC Client B plays Media to the PoC User B.

C.3.4 Local Granted Mode

This subclause shows an example of the case when the Local Granted Mode is used. The Local Grant mode is negotiated as specified in [OMA-PoC-CP].

Figure 28 "A PoC Client request permission to send Media using the Local Granted Mode" shows the message flow for the scenario.

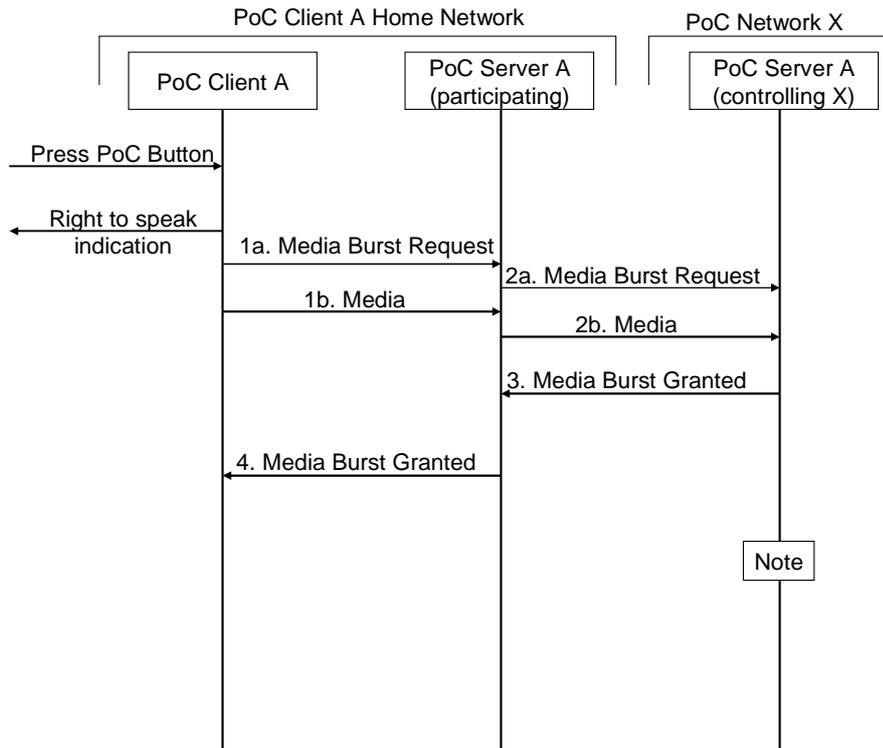

NOTE: For the MBCP message flow for PoC Users without permission to speak see Figure 30 "Another PoC User request the permission to send a Media Burst".

Figure 28: A PoC Client request permission to send Media using the Local Granted Mode

This procedure starts when no PoC Client has the permission to send a Media Burst.

A PoC User A at the PoC Client A presses the PoC button.

A PoC Server A (participating) has inserted itself in the Media Stream and all MBCP messages and RTP Media packet will go thru the PoC Server A (participating).

The steps of the flow are as follows:

1. A PoC User A at the PoC Client A presses the PoC button and
 - a. the PoC Client A sends a MBCP Media Burst Request message towards the PoC Server X (controlling); and at the same time,
 - b. the PoC Client A begins to send RTP Media packets towards the PoC Server X (controlling).
2. The PoC Server A (participating) modifies the IP address and port and
 - a. sends the MBCP Media Burst Request message to PoC Server X (controlling); and when Media packets are received,
 - b. sends the Media packets to PoC Server X (controlling). The Media packets will in almost every case be received after step 3 below but shown here as step 2b for simplicity.
3. The PoC Server X (controlling) determines that the PoC Client A can be given permission to send a Media Burst and sends a MBCP Media Burst Granted message towards the PoC Client A.

4. The PoC Server A (participating) modifies the IP address and port and sends the MBCP Media Burst Granted message to the PoC Client A.

C.4 Media Burst revoke procedure

The T2 (Stop Talking) in the PoC Server performing the Controlling PoC Function is used to limit the time that a PoC Client is permitted to send a Media Burst.

When T2 (Stop Talking) expires, the PoC Server performing the Controlling PoC Function sends a MBCP Media Burst Revoke message to the PoC Client that is sending the Media Burst and then starts the T3 (Stop Talking Grace) timer. This will allow the PoC Client time to gracefully complete the Media Burst before the PoC Server performing the Controlling PoC Function stops forwarding the RTP Media packets and sends out a MBCP Media Burst Idle message.

The message flow between the PoC Server performing the Controlling PoC Function and the receiving PoC Clients is the same for the Media Burst idle procedure and the Media Burst revoke procedure.

C.4.1 User A receives notification that the Media Burst permission is revoked

This subclause shows the desired scenario for the Media Burst revoke procedure i.e. a normal Media Burst release procedure occurs.

Figure 29 "*Media Burst Revoke procedure in PoC Server performing the Controlling PoC Function*" shows the message flow for the scenario.

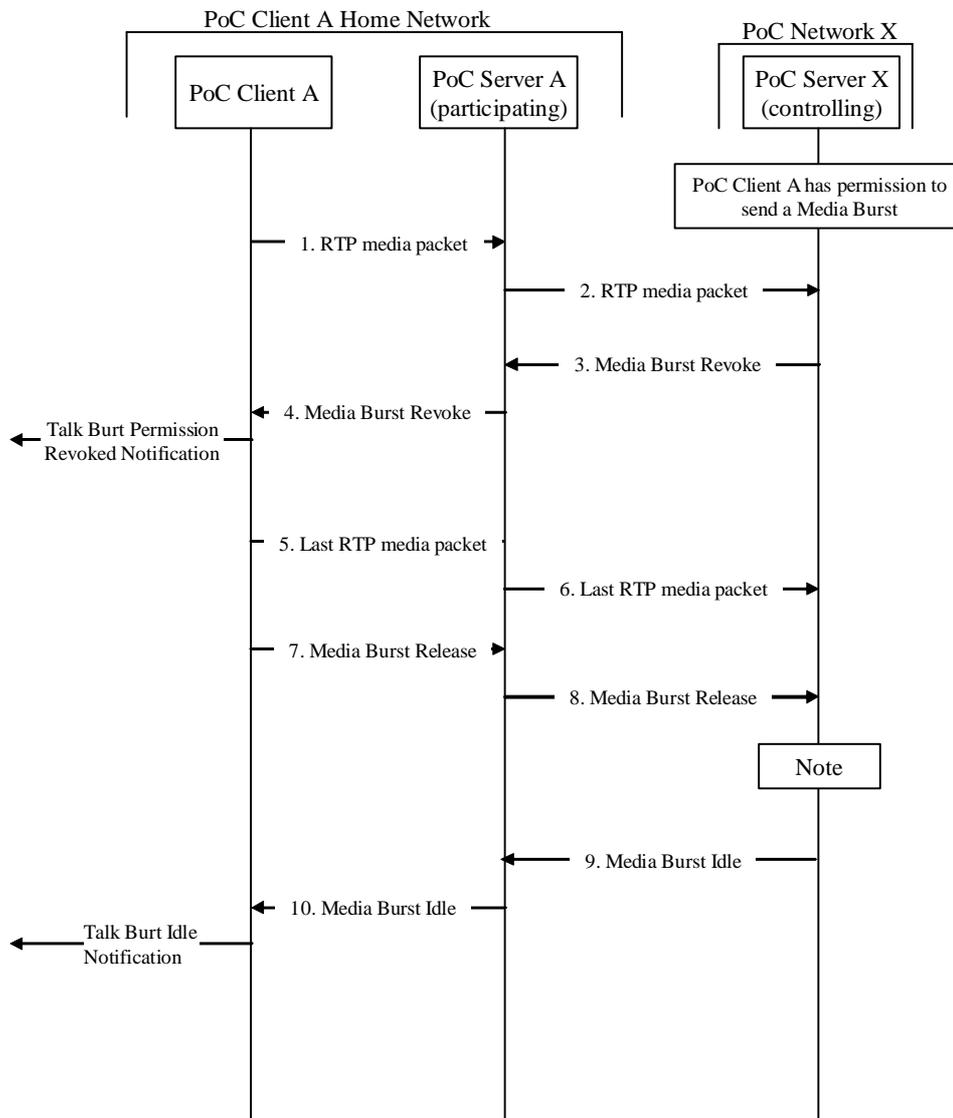

NOTE: For the MBCP message flow for PoC Users without permission to speak see Figure 24 "Media Burst idle procedure".

Figure 29: Media Burst revoke procedure in PoC Server performing the Controlling PoC Function

The PoC Client A, with the permission to send a Media Burst, is sending RTP Media packet when the timer T2 (Stop Talking) expires in the PoC Server (controlling).

A PoC Server A (participating) has inserted itself in the Media Stream and all MBCP messages and RTP Media packet will go thru the PoC Server A (participating).

The steps of the flow are as follows:

1. RTP Media packets are sent from the PoC Client A towards the PoC Server X (controlling).
2. The PoC Server A (participating) modifies the IP address and port of the RTP Media packets and sends them to the PoC Server X (controlling).

3. When the timer T2 (Stop Talking) expires in PoC Server X (controlling), the PoC Server X (controlling) sends a MBCP Media Burst Revoke message towards the PoC Client A and starts the T3 (Stop Talking Grace) timer. The message includes:
 - a. A reason code ('Media Burst too long'); and,
 - b. The value of the Retry-after timer.
4. The PoC Server A (participating) modifies the IP address and port and sends the MBCP Media Burst Revoke message to PoC Client A.

The PoC Client A sends a Media Burst revoke notification to the PoC User A.

The PoC Client starts the timer T12 (Retry After Timer), using the 'Retry-after timer' value contained in the MBCP Media Burst Revoke message.
5. The last RTP Media packet is sent from the PoC Client A towards the PoC Server X (controlling).
6. The PoC Server A (participating) modifies the IP address and port of the last RTP Media packet and sends the RTP Media packet to the PoC Server X (controlling).
7. The PoC Client A sends a MBCP Media Burst Release message towards the PoC Server X (controlling) to inform that the sending of the Media Burst is completed. The message includes:
 - a. The sequence number of the last RTP packet.
8. The PoC Server A (participating) modifies the IP address and port and sends the MBCP Media Burst Release message to the PoC Server X (controlling).
9. The PoC Server X (controlling) forwards the last RTP packet to all PoC Clients and sends MBCP Media Burst Idle message to all PoC Clients in the PoC Session, including the PoC Client A.
10. The PoC Server A modifies the IP address and port and sends the MBCP Media Burst Idle message to PoC Client A. The PoC Client A sends a Media Burst idle notification to the PoC User A.

NOTE: Sent RTCP SR/RR packets are described in the subclause B.6 "*Quality feedback flows*".

C.5 Media Burst release procedure

This subclause describes the normal case when a PoC User at a PoC Client, with the permission to send a Media Burst, has finished speaking and releases the PoC button.

Figure 30 "*Media Burst release procedure*" shows the message flow for the scenario.

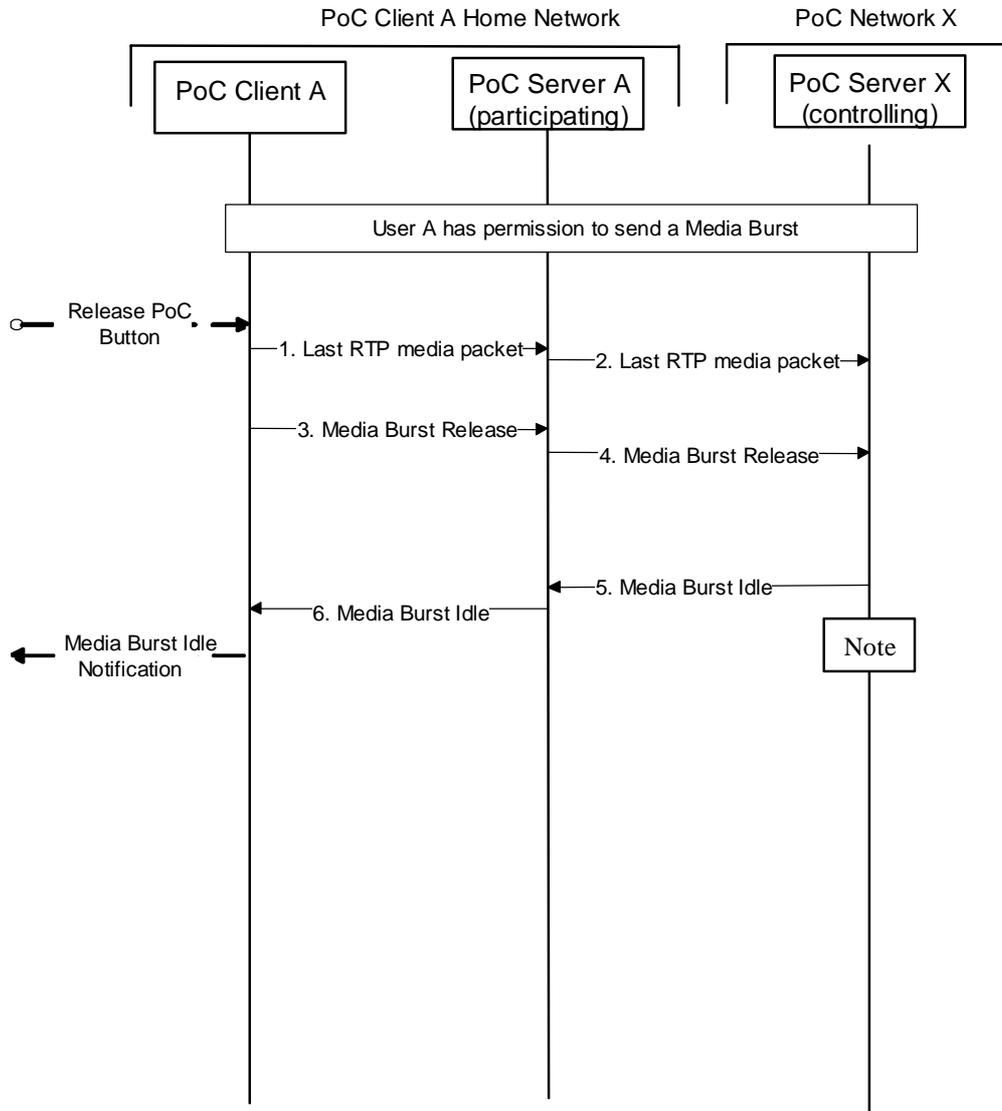

NOTE: For the MBCP message flow for PoC Users without permission to speak see Figure 24 "MBCP Media Burst idle procedure".

Figure 30: Media Burst release procedure

The PoC User A at the PoC Client A releases the PoC button.

The steps of the flow are as follows:

1. The PoC Client A sends the last RTP Media packet towards the PoC Server X (controlling).
2. The PoC Server A (participating) modifies the IP address and port and sends the last RTP Media packet to the PoC Server X (controlling).
3. After the last RTP packet has been sent, the PoC Client A sends a MBCP Media Burst Release message towards the PoC Server X (controlling) to inform that the Media Burst is complete. The message includes:
 1. The sequence number of the last RTP Media packet.

4. The PoC Server A (participating) modifies the IP address and port and sends the MBCP Media Burst Release message to PoC Server X (controlling).
5. After that the PoC Server X (controlling) has forwarded the last RTP Media packet to all PoC Clients, the PoC Server sends a MBCP Media Burst Idle message to all PoC Clients in the PoC Session, including the PoC Client A.
6. The PoC Server A (participating) modifies the IP address and port and sends the MBCP Media Burst Idle message to the PoC Client A. The PoC Client A sends a Media Burst idle notification to the PoC User A.

NOTE: Sent RTCP SR/RR packets are described in the subclause B.6 'Quality feedback flows'.

C.6 Quality feedback flows

This subclause describes the quality feedback exchange when a PoC User at a PoC Client, with the permission to send a Media Burst, has finished speaking and releases the PoC button.

Quality feedback is an optional feature, but if Quality feedback is supported, the PoC Clients and the PoC Servers exchange quality feedback reports.

Figure 31 "*RTCP SR compound packet from the PoC Client that transmitted the most recent Media Burst*" and Figure 32 "*RTCP RR compound packet from the receiving PoC Client*" shows all messages possible for the scenario.

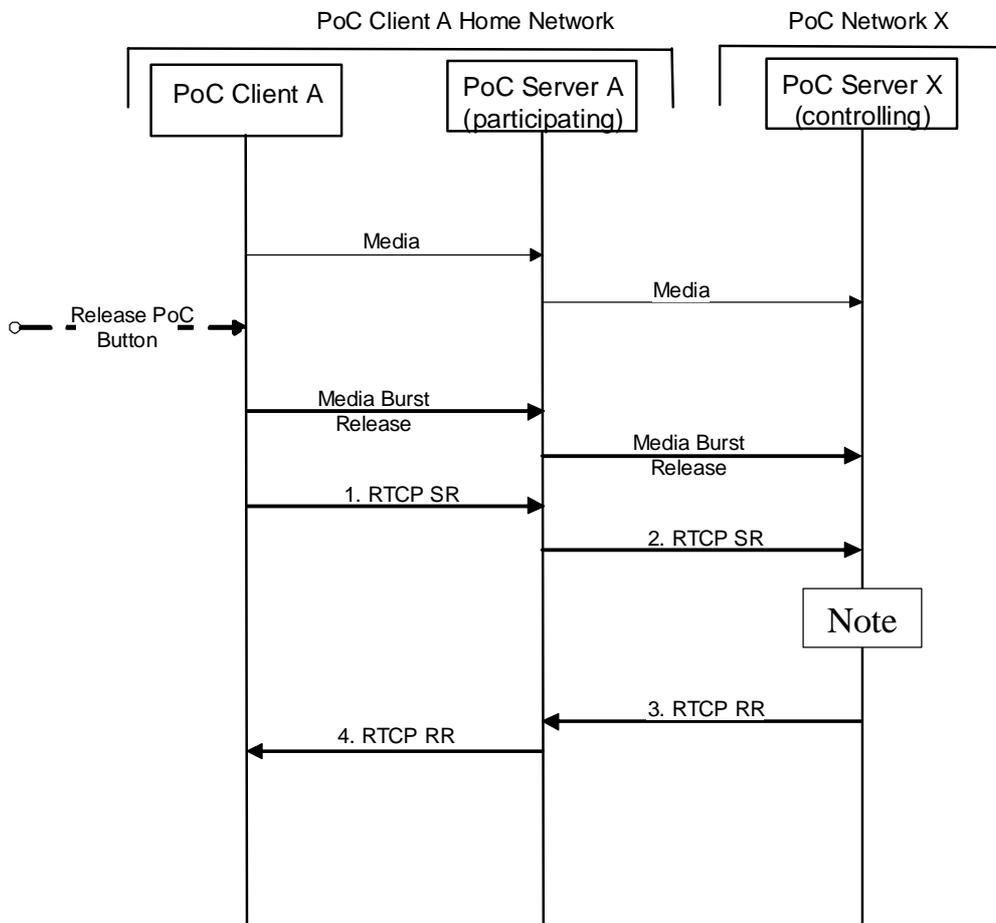

NOTE: For quality feed back message flows for PoC Clients receiving the Media Burst see Figure 32 "RTCP RR compound packet from the receiving PoC Client".

Figure 31: RTCP SR compound packet from the PoC Client that transmitted the most recent Media Burst

PoC Client A supports quality feedback. The PoC Server X (controlling) support the transmission of RTCP RR compound packets.

PoC Client A sends a MBCP Media Burst Release message towards the PoC Server X (controlling) to inform that the Media Burst is complete.

The steps of the flow are as follows:

1. PoC Client A compiles a sender report packet and sends the RTCP SR compound packet towards the PoC Server X (controlling).
2. PoC Server A (participating) modifies the IP address and port and sends the RTCP SR compound packet to PoC Server X (controlling). The PoC Server X (controlling) can be a monitor and thus uses the information in the sender report to keep statistics, estimate current quality of service for fault diagnosis.
3. The PoC Server X (controlling) can compile a receiver report packet and send the RTCP RR compound packet towards the PoC Client A.

- If the PoC Server A (participating) receives a RTCP RR message, The PoC Server modify the IP address and port and sends the RTCP RR compound packet to PoC Client A.

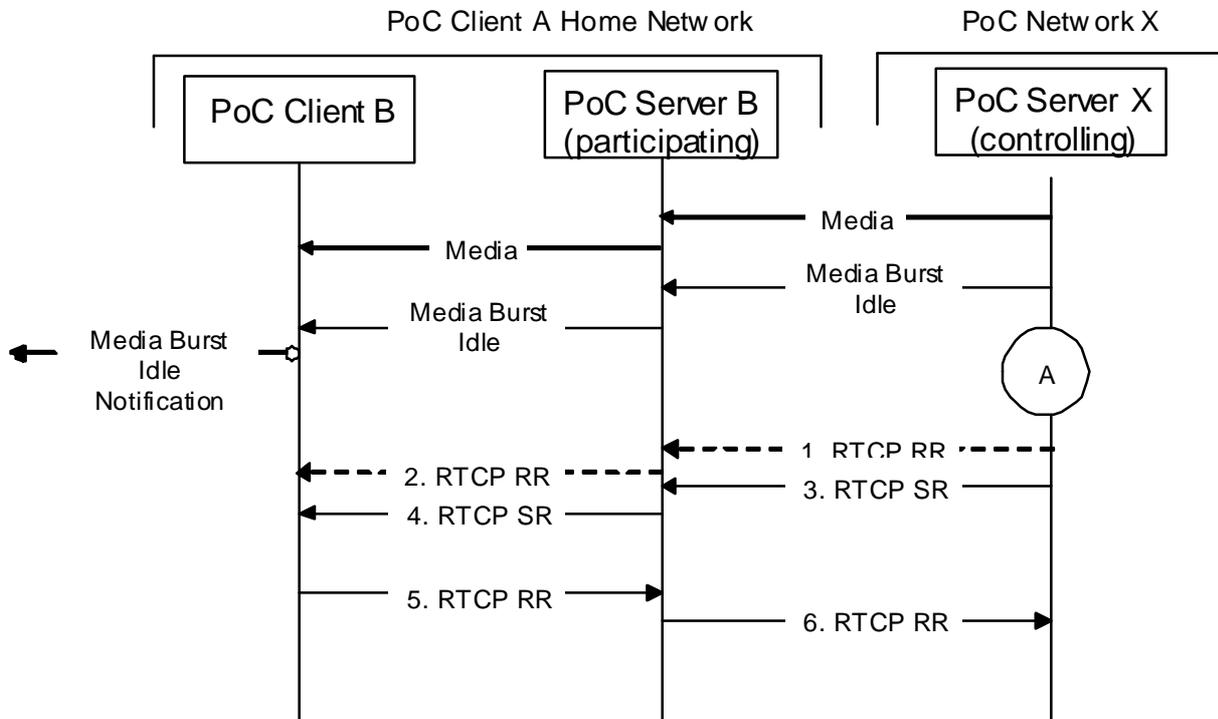

NOTE: For quality feed back message flows for PoC Clients sending the Media Burst Figure 31 "RTCP SR compound packet from the PoC Client that transmitted the most recent Media Burst".

Figure 32: RTCP RR compound packet from the receiving PoC Client

- The PoC Server X (controlling) can compile a receiver report packet and send the RTCP RR compound packet towards the PoC Client B.
- PoC Server B (participating) modifies the IP address and port and sends the RTCP RR compound packet to PoC Client B. The PoC Server B (participating) can be a monitor and thus uses the information for charging.
- The PoC Server X (controlling) receives a RTCP SR compound packet and modifies the IP address and port and sends the RTCP RR compound packet towards PoC Client B.
- PoC Server B (participating) modifies the IP address and port and sends the RTCP SR compound packet to PoC Client B.
- PoC Client B compiles a receiver report packet and sends the RTCP RR compound packet towards the PoC Server X (controlling) as soon as PoC Client B gets an indication that the received Media Burst has ended.
- PoC Server B (participating) modifies the IP address and port and sends the RTCP RR compound packet to PoC Server X (controlling). The PoC Server X (controlling) can be a monitor and thus uses the information in the receiver report to keep statistics, estimate current quality of service for fault diagnosis or can be used for charging.

C.7 Sender Identification flow

The PoC Server performing the participating PoC Function can either be in the Media path or not. The PoC Server performing the Controlling PoC Function get the knowledge which case it is as specified in [OMA-PoC-CP] "E.5.3 *Stay on Media path uri-parameter*".

The following subclauses show the message flow when the PoC Server performing Participating PoC Function is in the Media path and when the PoC Server performing Participating PoC Function is not in the Media path.

C.7.1 Without the Participating PoC Function in the Media path

This subclause contains an example flow that describes the Sender Identification procedure when the Participating PoC Function is not included in the Media path.

Figure 33 "*Identifying talking Participant in the PoC Client*" shows the message flow for the scenario.

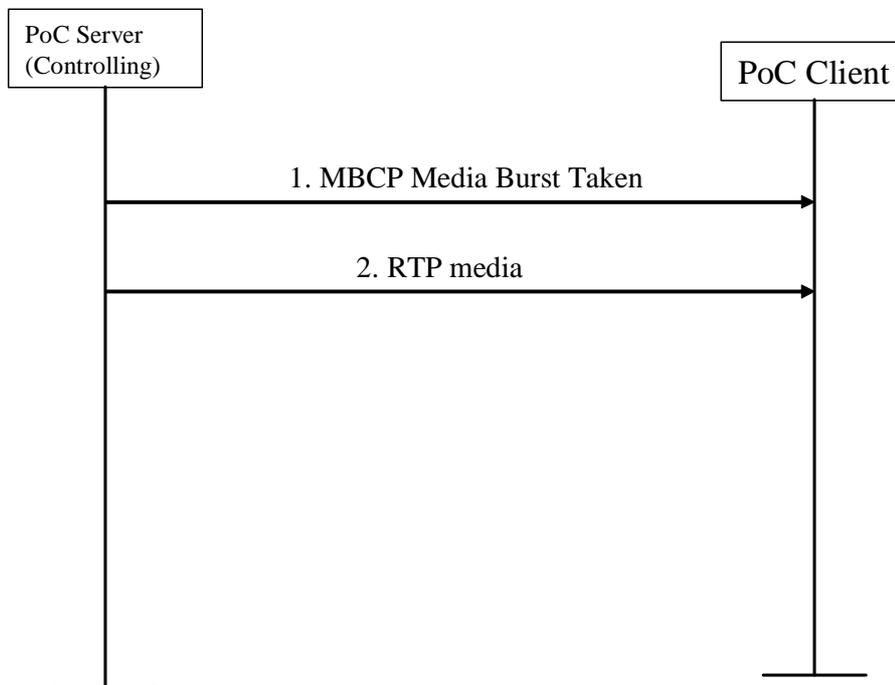

NOTE: The signalling flow is repeated for each Participant in the PoC Session.

Figure 33: Identifying talking Participant in the PoC Client, without the Participating PoC Function in the Media path

1. The PoC Server sends a MBCP Media Burst Taken message.

The MBCP Media Burst Taken message includes:

- a. The PoC Address (in the case the sender don't want to be anonymous); and,
- b. The Nick Name of the Participant that has been permitted to send a Media Burst.

2. PoC Server (controlling) sends RTP Media.

If the PoC Client has no mapping between the received PoC Address, the Nick Name and the SSRC identifier of the received RTP Media packet, or the PoC Client discover that the SSRC identifier of the PoC Client that transmits RTP Media packet has changed, the PoC Client can store the mapping between the received PoC Address, Nick Name and the SSRC identifier.

C.7.2 When the Participating PoC Function in the Media path

This subclause contains an example flow that describes the Sender Identification procedure when the Participating PoC Function is included in the Media path.

Figure 34 "Identifying talking Participant in the PoC Client" shows the message flow for the scenario.

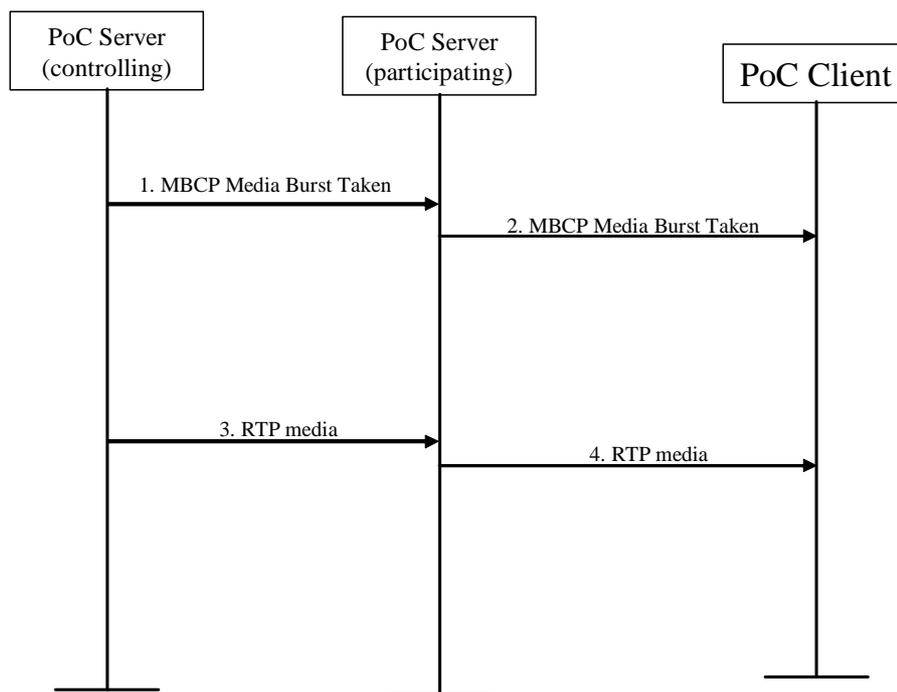

NOTE: The signalling flow is repeated for each Participant in the PoC Session.

Figure 34: Identifying talking Participant in the PoC Client, with the Participating PoC Function in the Media path

1. The PoC Server (controlling) sends a MBCP Media Burst Taken message.

The MBCP Media Burst Taken message includes:

- a. The PoC Address of the Participant with the permission to send Media (even if the sender wants to be anonymous); and,
- b. The Nick Name of the Participant that has been permitted to send a Media Burst.

2. The PoC Server B (participating) sends the MBCP Media Burst Taken message.

The MBCP Media Burst Taken message includes:

- a. The PoC Address of the Participant with the permission to send Media (in the case the sender don't want to be anonymous); and,
- b. The Nick Name of the Participant that has been permitted to send a Media Burst.

3. The PoC Server (controlling) sends RTP Media packets.
4. The PoC Server (participating forwards RTP Media packets.

If the PoC Client has no mapping between the received PoC Address, the Nick Name and the SSRC identifier of the received RTP Media packet, or the PoC Client discover that the SSRC identifier of the PoC Client that transmits RTP Media packet has changed, the PoC Client can store the mapping between the received PoC Address, Nick Name and the SSRC identifier.

C.8 PoC Session release in the Pre-established Session case

This subclause shows an example of the scenario when a PoC Server releases the PoC Media Session, but maintains the Pre-established Session.

Figure 35 "PoC Session release on the Pre-established Session case" shows the message flow for the scenario.

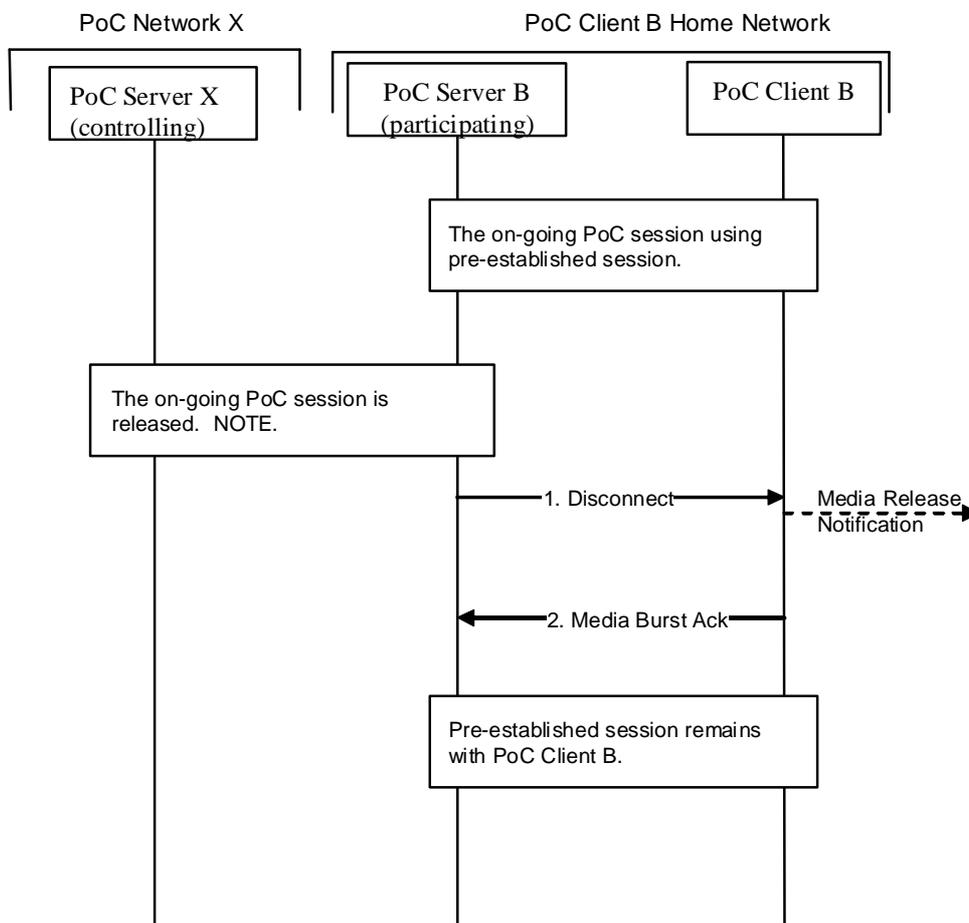

NOTE: While only 1 terminating PoC Client B is shown in the figure, this flow applies towards all terminating PoC Clients with a Pre-established Session invited to a PoC Session.

Figure 35: PoC Session release on the Pre-established Session case

A PoC Server B (participating) controls the Pre-established Session and all MBCP messages and RTP Media packets will go thru the PoC Server B (participating).

The steps of the flow are as follows:

1. The PoC Server B (participating) sends a MBCP Disconnect message to PoC Client B triggered by the SIP BYE request (from the PoC Server X). The PoC Client B presents the Media Session release to PoC User B.
2. The PoC Client B sends a MBCP Media Burst Acknowledgement message to PoC Server B (participating) to acknowledge the receipt of the MBCP Disconnect message.

C.9 Discrete Media flows

C.9.1 Discrete Media message with Discrete Media Transfer Final Report

This subclause shows an example of the scenario when a Participant of a three Participants PoC Session sends a Discrete Media message within Discrete Media not bound to a Media-floor Control Entity and requests the Discrete Media Transfer Final Report.

The MSRP message is artificially split to two chunks to show the Discrete Media Transfer Final Report, although normally the chunking would happen only with much larger message.

The PoC Client A negotiated the Discrete Media Transfer Final Report during the PoC Session establishment.

C.9.1.1 Originating flow

This subclause shows the messages of the scenario described in C.9.1 "*Discrete Media message with Discrete Media Transfer Final Report*" sent between the sending PoC Client A and the PoC Server X performing the Controlling PoC Function. The messages are routed through the PoC Server A performing the Participating PoC Function, which negotiated to stay on the Media path during the PoC Session establishment.

Figure 36 "*PoC Client A sends a Discrete Media message with Discrete Media Transfer Final Report*" shows the message flow for the scenario.

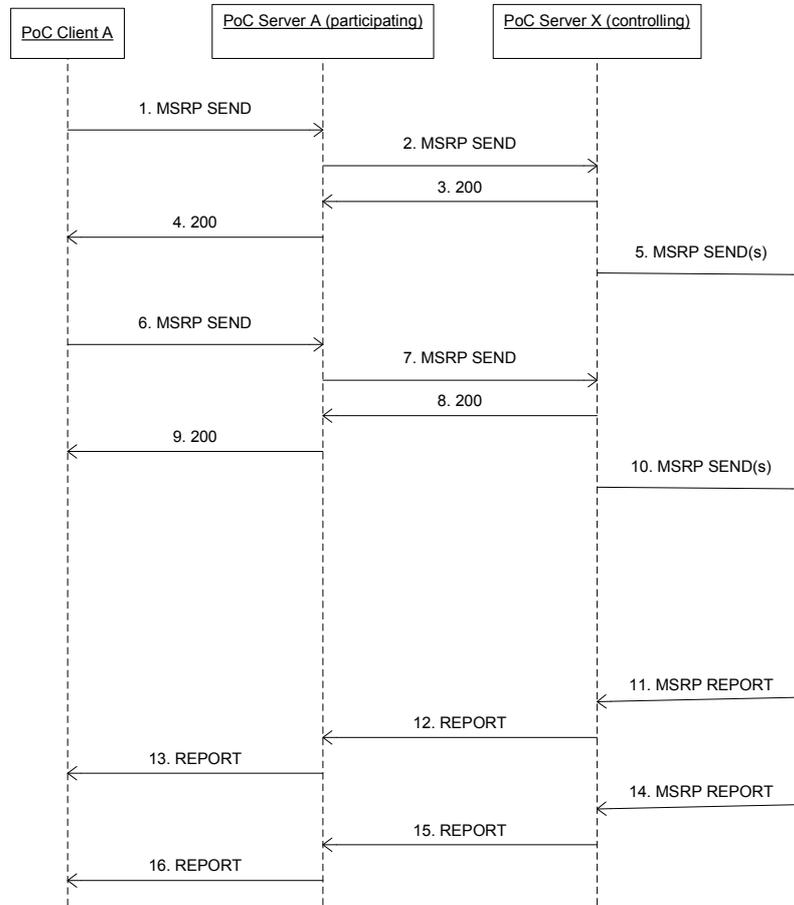

Figure 36: PoC Client A sends a Discrete Media message with Discrete Media Transfer Final Report

1. MSRP SEND request with the first chunk of the Discrete Media message (PoC Client A to PoC Server A)

```

MSRP dkei38sd SEND
To-Path: msrp://PoCServerAAddress:23456/pacaHshA7weztas;tcp
From-Path: msrp://[5555::aaa:bbb:ccc:ddd]:12345/caHkjhd37s2s20w2a;tcp
Message-ID: 4564dpWd
Byte-Range: 1-*/217
Success-Report: yes
Failure-Report: yes
Content-Type: message/cpim

From: sip:PoC-UserA@networkA.net
To: sip:PoC-SessionABCDEF@PoC-ServerX.networkX.net;session=adhoc
NS: FR <urn:oma:xml:poc:final-report>
FR.Final-Report: yes

Content-type: text/xml;charset=utf-8

abcd
-----dkei38sd+
    
```

2. MSRP SEND request with the first chunk of the Discrete Media message (PoC Server A to PoC Server X)

```
MSRP xxei38sd SEND
To-Path: msrp://PoCServerXAddress:55443/pxpaH68gnasdfg;tcp
From-Path: msrp://PoCServerAAddress:34567/papxHaghql;tcp
Message-ID: 4564dpWd
Byte-Range: 1-*/217
Success-Report: yes
Failure-Report: yes
Content-Type: message/cpim

From: sip:PoC-UserB@networkB.net
To: sip:PoC-SessionABCDEF@PoC-ServerX.networkX.net;session=adhoc
NS: FR <urn:oma+xml:poc:final-report>
FR.Final-Report: yes

Content-type: text/xml;charset=utf-8

abcd
-----xxei38sd+
```

3. 200 response to the MSRP SEND request (PoC Server X to PoC Server A)

```
MSRP xxei38sd 200 OK
To-Path: msrp://PoCServerAAddress:34567/papxHaghql;tcp
From-Path: msrp://PoCServerXAddress:55443/pxpaH68gnasdfg;tcp
Byte-Range: 1-209/217
-----xxei38sd$
```

4. 200 response to the MSRP SEND request (PoC Server A to PoC Client A)

```
MSRP dkei38sd 200 OK
To-Path: msrp://[5555::aaa:bbb:ccc:ddd]:12345/caHkjhd37s2s20w2a;tcp
From-Path: msrp://PoCServerAAddress:23456/pacaHshA7weztas;tcp
Byte-Range: 1-209/217
-----dkei38sd$
```

5. PoC Server X sends the first chunk of the Discrete Media message towards other Participants B and C in an MSRP SEND chunk

6. MSRP SEND request with the second chunk of the Discrete Media message (PoC Client A to PoC Server A)

```
MSRP gsdfgl5f SEND
To-Path: msrp://PoCServerAAddress:23456/pacaHshA7weztas;tcp
From-Path: msrp://[5555::aaa:bbb:ccc:ddd]:12345/caHkjhd37s2s20w2a;tcp
Message-ID: 4564dpWd
Byte-Range: 210-*/217
Success-Report: yes
Failure-Report: yes
Content-Type: message/cpim

efghijkl
-----gsdfgl5f$
```

7. MSRP SEND request with the second chunk of the Discrete Media message (PoC Server A to PoC Server X)

```
MSRP dfkjghw35il SEND
To-Path: msrp://PoCServerXAddress:55443/pxpaH68gnasdfg;tcp
From-Path: msrp://PoCServerAAddress:34567/papxHaghql;tcp
Message-ID: 4564dpWd
Byte-Range: 210-*/217
Success-Report: yes
Failure-Report: yes
Content-Type: message/cpim

efghijkl
-----dfkjghw35il$
```

8. 200 response to the MSRP SEND request (PoC Server X to PoC Server A)

```
MSRP dfkjghw35il 200 OK
To-Path: msrp://PoCServerAAddress:34567/papxHaghql;tcp
From-Path: msrp://PoCServerXAddress:55443/pxpaH68gnasdfg;tcp
Byte-Range: 210-217/217
-----dfkjghw35il$
```

9. 200 response to the MSRP SEND request (PoC Server A to PoC Client A)

```
MSRP gsdg15f 200 OK
To-Path: msrp://[5555::aaa:bbb:ccc:ddd]:12345/caHkjhd37s2s20w2a;tcp
From-Path: msrp://PoCServerAAddress:23456/pacaHshA7weztas;tcp
Byte-Range: 210-217/217
-----gsd15f$
```

10. PoC Server X sends the second chunk of the Discrete Media message towards other Participants B and C in an MSRP SEND chunk**11. PoC Server X receives an MSRP REPORT request from Participant C reporting that the complete Discrete Media message was successfully received at the PoC Client C****12. MSRP REPORT containing the Discrete Media Transfer Final Report of Participant C (PoC Server X to PoC Server A)**

```
MSRP x362562asgfasdf REPORT
To-Path: msrp://PoCServerAAddress:34567/papxHaghql;tcp
From-Path: msrp://PoCServerXAddress:55443/pxpaH68gnasdfg;tcp
Message-ID: 4564dpWd
Byte-Range: 1-1/217
Status: 000 200 OK
Content-Type: application/vnd.oma.poc.final-report+xml

<?xml version="1.0" encoding="UTF-8"?>
<final xmlns="urn:oma:xml:poc:final-report" Message-ID="4564dpWd">
<leg uri="sip:PoC-UserC@networkC.net" status="200"/>
</final>
```

-----x362562asgfasdf\$

13. MSRP REPORT containing the Discrete Media Transfer Final Report of Participant C (PoC Server A to PoC Client A)

```
MSRP gadfig34t4 REPORT
To-Path: msrp://[5555::aaa:bbb:ccc:ddd]:12345/caHkjhd37s2s20w2a;tcp
From-Path: msrp://PoCServerAAddress:23456/pacaHshA7weztas;tcp
Message-ID: 4564dpWd
Byte-Range: 1-1/217
Status: 000 200 OK
Content-Type: application/vnd.oma.poc.final-report+xml

<?xml version="1.0" encoding="UTF-8"?>
<final xmlns="urn:oma:xml:poc:final-report" Message-ID="4564dpWd">
<leg uri="sip:PoC-UserC@networkC.net" status="200"/>
</final>
-----gadfig34t4$
```

14. PoC Server X receives an MSRP REPORT request from Participant B reporting that the complete Discrete Media message was successfully received at the PoC Client B

15. MSRP REPORT containing the Discrete Media Transfer Final Report of Participant B (PoC Server X to PoC Server A)

```
MSRP adfgaf2341234yi REPORT
To-Path: msrp://PoCServerAAddress:34567/papxHaghql;tcp
From-Path: msrp://PoCServerXAddress:55443/pxpaH68gnasdfg;tcp
Message-ID: 4564dpWd
Byte-Range: 1-217/217
Status: 000 200 OK
Content-Type: application/vnd.oma.poc.final-report+xml

<?xml version="1.0" encoding="UTF-8"?>
<final xmlns="urn:oma:xml:poc:final-report" Message-ID="4564dpWd" last="true">
<leg uri="sip:PoC-UserB@networkB.net" status="200"/>
</final>
-----adfgaf2341234yi$
```

16. MSRP REPORT containing the Discrete Media Transfer Final Report of Participant B (PoC Server A to PoC Client A)

```
MSRP dfagaa346il REPORT
To-Path: msrp://[5555::aaa:bbb:ccc:ddd]:12345/caHkjhd37s2s20w2a;tcp
From-Path: msrp://PoCServerAAddress:23456/pacaHshA7weztas;tcp
Message-ID: 4564dpWd
Byte-Range: 1-217/217
Status: 000 200 OK
Content-Type: application/vnd.oma.poc.final-report+xml

<?xml version="1.0" encoding="UTF-8"?>
<final xmlns="urn:oma:xml:poc:final-report" Message-ID="4564dpWd" last="true">
<leg uri="sip:PoC-UserB@networkB.net" status="200"/>
</final>
-----dfagaa346il$
```

C.9.1.2 Terminating flow

This subclause shows the messages of the scenario described in C.9.1 "Discrete Media message with Discrete Media Transfer Final Report" sent between the PoC Server X performing the Controlling PoC Function and a receiving PoC Client B. The messages are routed through the PoC Server B performing the Participating PoC Function, which negotiated to stay on the Media path during the PoC Session establishment.

Figure 37 "PoC Client B receives a Discrete Media message" shows the message flow for the scenario.

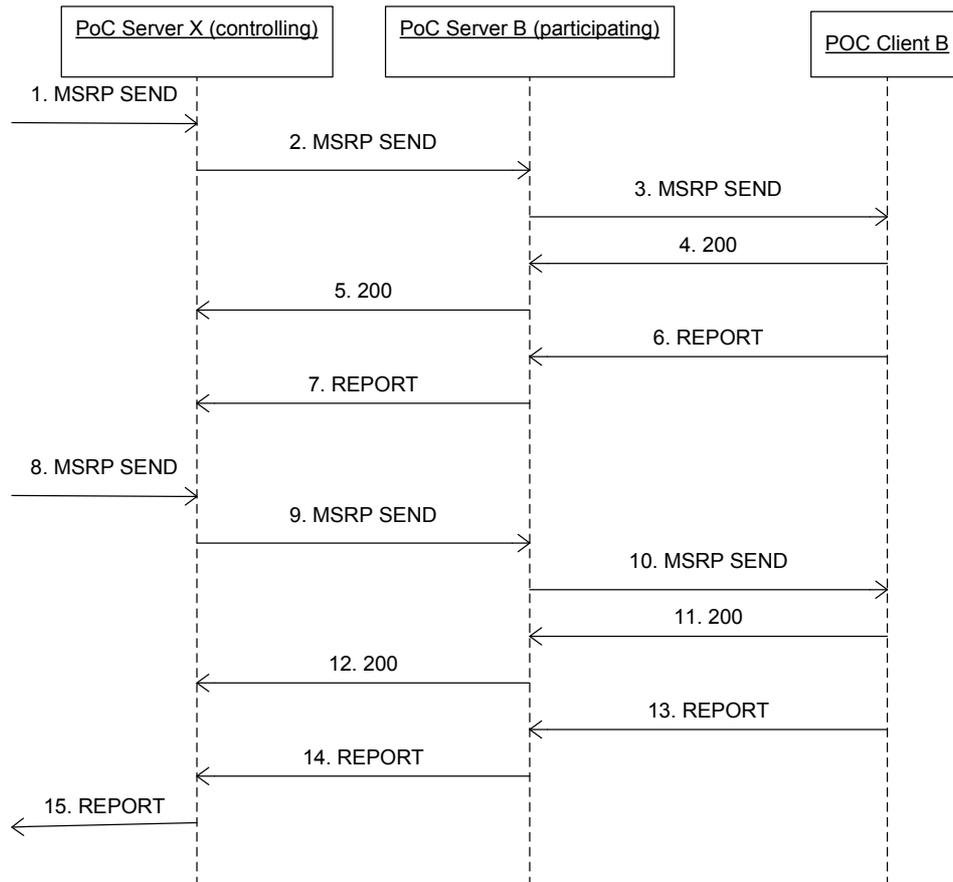

Figure 37: PoC Client B receives a Discrete Media message

1. PoC Server X receives the first chunk of the Discrete Media message from the Participant A
2. MSRP SEND request with the first chunk of the Discrete Media message (PoC Server X to PoC Server B)

```

MSRP xxxadfgfaqw234 SEND
To-Path: msrp://PoCServerBAddress:64456/pbpxHsdfgjsztas;tcp
From-Path: msrp://PoCServerXAddress:23456/pxpbHfjghsdf1;tcp
Message-ID: 4564dpWd
Byte-Range: 1-*/156
Success-Report: yes
    
```

```

Failure-Report: yes
Content-Type: message/cpim

From: sip:PoC-UserA@networkA.net
To: sip:PoC-SessionABCDEF@PoC-ServerX.networkX.net;session=adhoc

Content-type: text/xml;charset=utf-8

abcd
-----xxxadfgfaqw234+

```

3. MSRP SEND request with the first chunk of the Discrete Media message (PoC Server B to PoC Client B)

```

MSRP yyyadfgfaqw234 SEND
To-Path: msrp://[6666::ddd:eee:fff:ddd]:45678/cbHjtp34;tcp
From-Path: msrp://PoCServerBAddress:15678/pbcbH34uit5af;tcp
Message-ID: 4564dpWd
Byte-Range: 1-*/156
Success-Report: yes
Failure-Report: yes
Content-Type: message/cpim

From: sip:PoC-UserA@networkA.net
To: sip:PoC-SessionABCDEF@PoC-ServerX.networkX.net;session=adhoc

Content-type: text/xml;charset=utf-8

abcd
-----yyyadfgfaqw234+

```

4. 200 response to the MSRP SEND request (PoC Client B to PoC Server B)

```

MSRP yyyadfgfaqw234 200 OK
To-Path: msrp://PoCServerBAddress:15678/pbcbH34uit5af;tcp
From-Path: msrp://[6666::ddd:eee:fff:ddd]:45678/cbHjtp34;tcp
Byte-Range: 1-148/156
-----yyyadfgfaqw234$

```

5. 200 response to the MSRP SEND request (PoC Server B to PoC Server X)

```

MSRP xxxadfgfaqw234 200 OK
To-Path: msrp://PoCServerXAddress:23456/pxpbHfjghsdfl;tcp
From-Path: msrp://PoCServerBAddress:64456/pbpxHsdgjsztas;tcp
Byte-Range: 1-148/156
-----xxxadfgfaqw234$

```

6. MSRP REPORT (PoC Client B to PoC Server B)

```

MSRP x45y6456526 REPORT
To-Path: msrp://PoCServerBAddress:15678/pbcbH34uit5af;tcp
From-Path: msrp://[6666::ddd:eee:fff:ddd]:45678/cbHjtp34;tcp
Message-ID: 4564dpWd
Byte-Range: 1-148/156
Status: 000 200 OK

```

-----x45y6456526\$

7. MSRP REPORT (PoC Server B to PoC Server X)

```
MSRP a567567 REPORT
To-Path: msrp://PoCServerXAddress:23456/pxpbHfjghsdf1;tcp
From-Path: msrp://PoCServerBAddress:64456/pbpxHsdfgjsztas;tcp
Message-ID: 4564dpWd
Byte-Range: 1-148/156
Status: 000 200 OK
-----a567567$
```

8. PoC Server X receives the second chunk of the Discrete Media message from the Participant A

9. MSRP SEND request with the second chunk of the Discrete Media message (PoC Server X to PoC Server B)

```
MSRP zzqw23 SEND
To-Path: msrp://PoCServerBAddress:64456/pbpxHsdfgjsztas;tcp
From-Path: msrp://PoCServerXAddress:23456/pxpbHfjghsdf1;tcp
Message-ID: 4564dpWd
Byte-Range: 149-*/156
Success-Report: yes
Failure-Report: yes
Content-Type: message/cpim

efghijkl
-----zzqw23$
```

10. MSRP SEND request with the second chunk of the Discrete Media message (PoC Server B to PoC Client B)

```
MSRP ttsdfgsw24 SEND
To-Path: msrp://[6666::ddd:eee:fff:ddd]:45678/cbHjtp34;tcp
From-Path: msrp://PoCServerBAddress:15678/pbcbH34uit5af;tcp
Message-ID: 4564dpWd
Byte-Range: 149-*/156
Success-Report: yes
Failure-Report: yes
Content-Type: message/cpim

efghijkl
-----ttsdfgsw24$
```

11. 200 response to the MSRP SEND request (PoC Client B to PoC Server B)

```
MSRP ttsdfgsw24 200 OK
To-Path: msrp://PoCServerBAddress:15678/pbcbH34uit5af;tcp
From-Path: msrp://[6666::ddd:eee:fff:ddd]:45678/cbHjtp34;tcp
Byte-Range: 149-156/156
-----ttsdfgsw24$
```

12. 200 response to the MSRP SEND request (PoC Server B to PoC Server X)

```
MSRP zzqw23 200 OK
To-Path: msrp://PoCServerXAddress:23456/pxpbHfjghsdf1;tcp
From-Path: msrp://PoCServerBAddress:64456/pbpxHsdfgjsztas;tcp
Byte-Range: 149-156/156
-----zzqw23$
```

13. MSRP REPORT (PoC Client B to PoC Server B)

```
MSRP ax45y646 REPORT
To-Path: msrp://PoCServerBAddress:15678/pbcbH34uit5af;tcp
From-Path: msrp://[6666::ddd:eee:fff:ddd]:45678/cbHjtp34;tcp
Message-ID: 4564dpWd
Byte-Range: 1-156/156
Status: 000 200 OK
-----ax45y646$
```

14. MSRP REPORT (PoC Server B to PoC Server X)

```
MSRP bv7567 REPORT
To-Path: msrp://PoCServerXAddress:23456/pxpbHfjghsdf1;tcp
From-Path: msrp://PoCServerBAddress:64456/pbpxHsdfgjsztas;tcp
Message-ID: 4564dpWd
Byte-Range: 1-156/156
Status: 000 200 OK
-----bv7567$
```

15. PoC Server X informs the Participant A about the final delivery of the Discrete Media message to the PoC Client B.

C.10 Discrete Media flows

C.10.1 Discrete Media message with detailed Discrete Media Transfer Progress Report

This subclause shows an example of the scenario when a Participant of a four Participants PoC Session sends a Discrete Media message within Discrete Media not bound to a Media-floor Control Entity and requests the detailed Discrete Media Transfer Progress Report.

The MSRP message is artificially split to two chunks to show the Discrete Media Transfer Final Report, although normally the chunking would happen only with much larger message.

The PoC Clients A, B, C did not negotiate any maximum receive message size, the PoC Client D negotiated maximum receive message size 10. The PoC Client D negotiated maximum receive message size is artificially low to show the detailed Discrete Media Transfer Progress Report content, when the negotiated maximum receive message size is lower than sent Discrete Media message size.

The PoC Client A negotiated the detailed Discrete Media Transfer Progress Report during the PoC Session establishment.

C.10.1.1 Originating flow

This subclause shows the messages of the scenario described in C.10.1 "Discrete Media message with detailed Discrete Media Transfer Progress Report" sent between the sending PoC Client A and the PoC Server X performing the Controlling PoC Function. The messages are routed through the PoC Server A performing the Participating PoC Function, which negotiated to stay on the Media path during the PoC Session establishment.

Figure 38 "PoC Client A sends a Discrete Media message with detailed Discrete Media Transfer Progress Report" shows the message flow for the scenario.

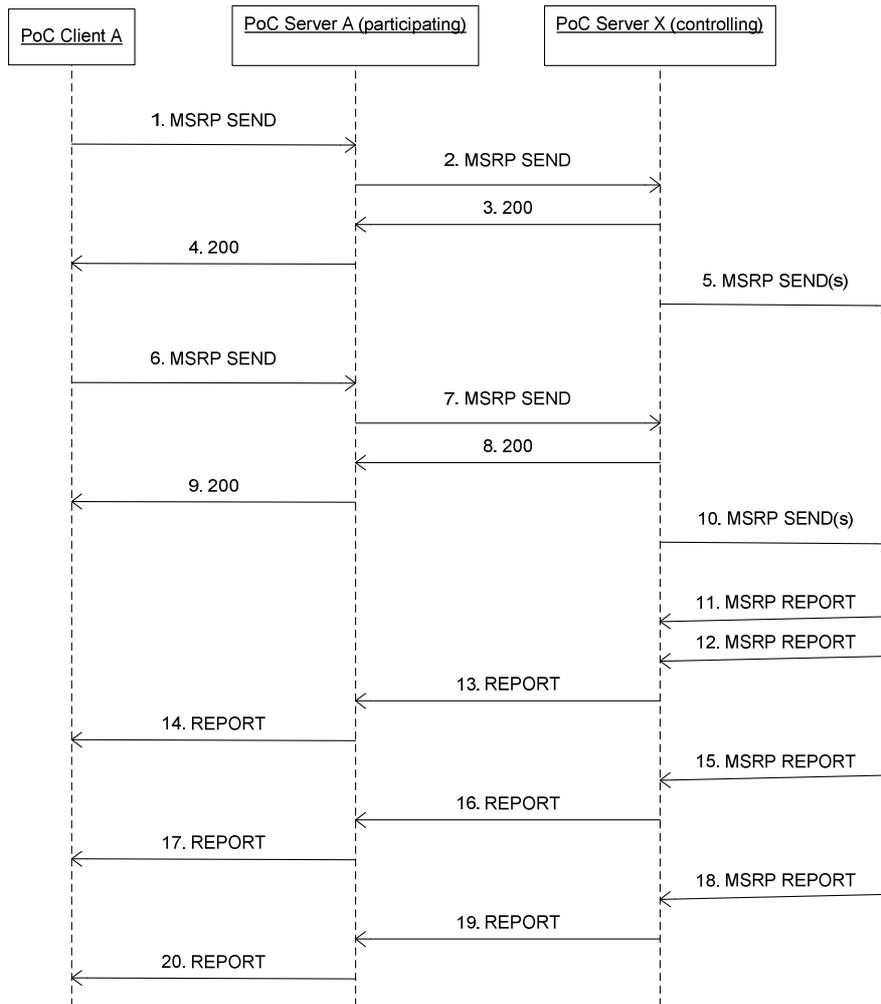

Figure 38: PoC Client A sends a Discrete Media message with detailed Discrete Media Transfer Progress Report

1. MSRP SEND request with the first chunk of the Discrete Media message (PoC Client A to PoC Server A)

```

MSRP dkei38sd SEND
To-Path: msrp://PoCServerAAddress:23456/pacaHshA7weztas;tcp
From-Path: msrp://[5555::aaa:bbb:ccc:ddd]:12345/caHkjhd37s2s20w2a;tcp
Message-ID: 4564dpWd
Byte-Range: 1-*/233
    
```

Success-Report: yes
 Failure-Report: yes
 Content-Type: message/cpim

From: sip:PoC-UserA@networkA.net
 To: sip:PoC-SessionABCDEF@PoC-ServerX.networkX.net;session=adhoc
 NS: PR <urn:oma:xml:poc:det-progress-rep>
 PR.Detailed-Progress-Report: yes

Content-type: text/xml;charset=utf-8

abcd
 -----dkei38sd+

2. MSRP SEND request with the first chunk of the Discrete Media message (PoC Server A to PoC Server X)

MSRP xxei38sd SEND
 To-Path: msrp://PoCServerXAddress:55443/pxpaH68gnasdfg;tcp
 From-Path: msrp://PoCServerAAddress:34567/papxHaghql;tcp
 Message-ID: 4564dpWd
 Byte-Range: 1-*/233
 Success-Report: yes
 Failure-Report: yes
 Content-Type: message/cpim

From: sip:PoC-UserB@networkB.net
 To: sip:PoC-SessionABCDEF@PoC-ServerX.networkX.net;session=adhoc
 NS: PR <urn:oma:xml:poc:det-progress-rep>
 PR.Detailed-Progress-Report: yes

Content-type: text/xml;charset=utf-8

abcd
 -----xxei38sd+

3. 200 response to the MSRP SEND request (PoC Server X to PoC Server A)

MSRP xxei38sd 200 OK
 To-Path: msrp://PoCServerAAddress:34567/papxHaghql;tcp
 From-Path: msrp://PoCServerXAddress:55443/pxpaH68gnasdfg;tcp
 Byte-Range: 1-225/233
 -----xxei38sd\$

4. 200 response to the MSRP SEND request (PoC Server A to PoC Client A)

MSRP dkei38sd 200 OK
 To-Path: msrp://[5555::aaa:bbb:ccc:ddd]:12345/caHkjhd37s2s20w2a;tcp
 From-Path: msrp://PoCServerAAddress:23456/pacaHshA7weztas;tcp
 Byte-Range: 1-225/233
 -----dkei38sd\$

5. PoC Server X sends the first chunk of the Discrete Media message towards other Participants B and C in an MSRP SEND chunk

6. MSRP SEND request with the second chunk of the Discrete Media message (PoC Client A to PoC Server A)

```

MSRP gsdfgl5f SEND
To-Path: msrp://PoCServerAAddress:23456/pacaHshA7weztas;tcp
From-Path: msrp://[5555::aaa:bbb:ccc:ddd]:12345/caHkjhd37s2s20w2a;tcp
Message-ID: 4564dpWd
Byte-Range: 226-*/233
Success-Report: yes
Failure-Report: yes
Content-Type: message/cpim

efghijkl
-----gsdfgl5f$

```

7. MSRP SEND request with the second chunk of the Discrete Media message (PoC Server A to PoC Server X)

```

MSRP dfkjghw35il SEND
To-Path: msrp://PoCServerXAddress:55443/pxpaH68gnasdfg;tcp
From-Path: msrp://PoCServerAAddress:34567/papxHaghql;tcp
Message-ID: 4564dpWd
Byte-Range: 226-*/233
Success-Report: yes
Failure-Report: yes
Content-Type: message/cpim

efghijkl
-----dfkjghw35il$

```

8. 200 response to the MSRP SEND request (PoC Server X to PoC Server A)

```

MSRP dfkjghw35il 200 OK
To-Path: msrp://PoCServerAAddress:34567/papxHaghql;tcp
From-Path: msrp://PoCServerXAddress:55443/pxpaH68gnasdfg;tcp
Byte-Range: 226-233/233
-----dfkjghw35il$

```

9. 200 response to the MSRP SEND request (PoC Server A to PoC Client A)

```

MSRP gsdfgl5f 200 OK
To-Path: msrp://[5555::aaa:bbb:ccc:ddd]:12345/caHkjhd37s2s20w2a;tcp
From-Path: msrp://PoCServerAAddress:23456/pacaHshA7weztas;tcp
Byte-Range: 226-233/233
-----gsdfgl5f$

```

10. PoC Server X sends the second chunk of the Discrete Media message towards other Participants B and C in an MSRP SEND chunk**11. PoC Server X receives an MSRP REPORT request from Participant B reporting that a part of the Discrete Media message was successfully received at the PoC Client B. Since this is not the final report yet, the PoC Server X starts a timer to wait for REPORTs from other Participants.**

12. PoC Server X receives an MSRP REPORT request from Participant C reporting that a part of the Discrete Media message was successfully received at the PoC Client C. Since this is not the final report yet and since the timer is running, the PoC Server X decides to wait for the timer expiration or for a REPORT reporting complete Discrete Media message delivery.

13. When the timer fires, the PoC Server sends the REPORT with the progress report to the PoC Client A.

```
MSRP y2asjjjgfasdf REPORT
To-Path: msrp://PoCServerAAddress:34567/papxHaghql;tcp
From-Path: msrp://PoCServerXAddress:55443/pxpaH68gnasdfg;tcp
Message-ID: 4564dpWd
Byte-Range: 1-1/233
Status: 000 200 OK
Content-Type: application/vnd.oma.poc.detailed-progress-report+xml

<?xml version="1.0" encoding="UTF-8" ?>
<det-progress xmlns="urn:oma:xml:poc:det-progress-rep">
  <leg uri="sip:PoC-UserC@networkC.net" sent="225"/>
  <leg uri="sip:PoC-UserB@networkB.net" sent="225"/>
  <leg uri="sip:PoC-UserD@networkC.net" status="9999" max-size="10"/>
</det-progress>
-----y2asjjjgfasdf$
```

14. MSRP REPORT containing the Discrete Media Transfer Final Report of Participant C (PoC Server A to PoC Client A)

```
MSRP ttuugadfig REPORT
To-Path: msrp://[5555::aaa:bbb:ccc:ddd]:12345/caHkjhd37s2s20w2a;tcp
From-Path: msrp://PoCServerAAddress:23456/pacaHshA7weztas;tcp
Message-ID: 4564dpWd
Byte-Range: 1-1/233
Status: 000 200 OK
Content-Type: application/vnd.oma.poc.detailed-progress-report+xml

<?xml version="1.0" encoding="UTF-8" ?>
<det-progress xmlns="urn:oma:xml:poc:det-progress-rep">
  <leg uri="sip:PoC-UserC@networkC.net" sent="225"/>
  <leg uri="sip:PoC-UserB@networkB.net" sent="225"/>
  <leg uri="sip:PoC-UserD@networkC.net" status="9999" max-size="10"/>
</det-progress>
-----ttuugadfig$
```

15. PoC Server X receives an MSRP REPORT request from Participant C reporting that the complete Discrete Media message was successfully received at the PoC Client C

16. MSRP REPORT containing the Discrete Media Transfer Final Report of Participant C (PoC Server X to PoC Server A)

```
MSRP x362562asgfasdf REPORT
To-Path: msrp://PoCServerAAddress:34567/papxHaghql;tcp
From-Path: msrp://PoCServerXAddress:55443/pxpaH68gnasdfg;tcp
Message-ID: 4564dpWd
Byte-Range: 1-2/233
Status: 000 200 OK
Content-Type: application/vnd.oma.poc.detailed-progress-report+xml
```

```
<?xml version="1.0" encoding="UTF-8" ?>
<det-progress xmlns="urn:oma:xml:poc:det-progress-rep">
  <leg uri="sip:PoC-UserC@networkC.net" status="200"/>
</det-progress>
-----x362562asgfasdf$
```

17. MSRP REPORT containing the Discrete Media Transfer Final Report of Participant C (PoC Server A to PoC Client A)

```
MSRP gadfig34t4 REPORT
To-Path: msrp://[5555::aaa:bbb:ccc:ddd]:12345/caHkJhd37s2s20w2a;tcp
From-Path: msrp://PoCServerAAddress:23456/pacaHshA7weztas;tcp
Message-ID: 4564dpWd
Byte-Range: 1-2/233
Status: 000 200 OK
Content-Type: application/vnd.oma.poc.detailed-progress-report+xml

<?xml version="1.0" encoding="UTF-8" ?>
<det-progress xmlns="urn:oma:xml:poc:det-progress-rep">
  <leg uri="sip:PoC-UserC@networkC.net" status="200"/>
</det-progress>
-----gadfig34t4$
```

18. PoC Server X receives an MSRP REPORT request from Participant B reporting that the complete Discrete Media message was successfully received at the PoC Client B

19. MSRP REPORT containing the Discrete Media Transfer Final Report of Participant B (PoC Server X to PoC Server A)

```
MSRP adfgaf2341234yi REPORT
To-Path: msrp://PoCServerAAddress:34567/papxHaghq1;tcp
From-Path: msrp://PoCServerXAddress:55443/pxpaH68gnasdfg;tcp
Message-ID: 4564dpWd
Byte-Range: 1-233/233
Status: 000 200 OK
Content-Type: application/vnd.oma.poc.detailed-progress-report+xml

<?xml version="1.0" encoding="UTF-8" ?>
<det-progress xmlns="urn:oma:xml:poc:det-progress-rep">
  <leg uri="sip:PoC-UserB@networkB.net" status="200"/>
</det-progress>
-----adfgaf2341234yi$
```

20. MSRP REPORT containing the Discrete Media Transfer Final Report of Participant B (PoC Server A to PoC Client A)

```
MSRP dfagaa346il REPORT
To-Path: msrp://[5555::aaa:bbb:ccc:ddd]:12345/caHkJhd37s2s20w2a;tcp
From-Path: msrp://PoCServerAAddress:23456/pacaHshA7weztas;tcp
Message-ID: 4564dpWd
Byte-Range: 1-233/233
Status: 000 200 OK
Content-Type: application/vnd.oma.poc.detailed-progress-report+xml

<?xml version="1.0" encoding="UTF-8" ?>
```

```
<det-progress xmlns="urn:oma:xml:poc:det-progress-rep">
  <leg uri="sip:PoC-UserB@networkB.net" status="200"/>
</det-progress>
-----dfagaa346il$
```

C.10.1.2 Terminating flow

The terminating flow is the same as the subclause C.9.1.2 "*Terminating flow*".

Appendix D. RTP Session description parameters (Informative)

When the PoC Client uses the AMR-NB or AMR-WB RTP payload format, the PoC Client uses either the bandwidth-efficient mode or the octet-aligned mode of the IETF AMR-NB and AMR-WB RTP payload format. For interoperability, the PoC Client should support both octet-aligned mode and bandwidth-efficient mode for single channel as recommended in section 4.5 *"Implementation Considerations"* of [RFC3267].

For OMA PoC Service, the OMA PoC Client that supports 3GPP AMR speech codec, the PoC Client can construct an SDP answer for a payload type in an SDP answer from a payload type in an SDP offer with the following parameters of [RFC3267]:

- Octet-align=1 or no octet-align parameter;
- Maxptime: 400;
- crc=0 or no crc parameter;
- robust-sorting=0 (or no robust-sorting parameter);
- no interleaving parameter, and
- channels=1 or no channels parameter.

Appendix E. Documentation of XML extensions

E.1 Discrete Media Transfer Final Report

E.1.1 Structure of the Discrete Media Transfer Final Report

The Discrete Media Transfer Final Report is an XML document that must be well formed and has to be valid. The Discrete Media Transfer Final Report documents are based on XML 1.0 and use UTF-8 encoding. This specification makes use of XML namespaces for identifying the Discrete Media Transfer Final Report documents and document fragments. The namespace URI for elements defined by this specification is a URN, using the namespace identifier 'oma'. This URN is:

```
urn:oma:xml:poc:final-report
```

The Discrete Media Transfer Final Report document begins with the root <final> element.

The <final> element consists of number of <leg> elements and two attributes, "last" and "Message-ID". The "Message-ID" attribute contains the Message-ID of the MSRP message for which the Discrete Media Transfer Final Report is generated. The "last" attribute with value "true" indicates the last Discrete Media Transfer Final Report document for the MSRP message identified by the "Message-ID" attribute.

Each <leg> element contains a mandatory "uri" attribute containing the URI of the recipient and a "status" attribute with or without a "max-size" attribute. If the "status" attribute is missing, the <leg> element is ignored.

If the Discrete Media was completely delivered to the Participant or if the Discrete Media delivery to the Participant failed, the <leg> element contains the "status" attribute containing the MSRP status code of the recipient indicated with 'uri' attribute.

If the Discrete Media cannot be sent to the Participant because the Participant has negotiated the SDP attribute "a=max-size" lower than the Discrete Media size, the <leg> element contains the "status" attribute with value "9999" and the "max-size" attribute with the value corresponding to the SDP attribute "a=max-size" negotiated by the Participant indicated with 'uri' attribute.

The Discrete Media Transfer Final Report document shall be identified with the MIME content type "application/vnd.oma.poc.final-report+xml".

E.1.1.1 Example of Discrete Media Transfer Final Report

```
<?xml version="1.0" encoding="UTF-8"?>
<final xmlns="urn:oma:xml:poc:final-report" Message-ID="r2d2" last="true">
  <leg uri="sip:userC@example.com" status="200"/>
  <leg uri="sip:userD@example.com" status="413"/>
  <leg uri="sip:userF@example.com" status="9999" max-size="50000"/>
</final>
```

E.1.1.2 XML Schema for the Discrete Media Transfer Final Report

The Discrete Media Transfer Final Report document SHALL conform to the XML schema described in [OMA-PoC-FINAL-REP].

E.2 Discrete Media Transfer Progress Reports

E.2.1 Structure of the detailed Discrete Media Transfer Progress Report

The detailed Discrete Media Transfer Progress Report is an XML document that must be well formed and has to be valid. The detailed Discrete Media Transfer Progress Report document is based on XML 1.0 and uses UTF-8 encoding. This specification makes use of XML namespaces for identifying the detailed Discrete Media Transfer Progress Report document and document fragments. The namespace URI for elements defined by this specification is a URN, using the namespace identifier 'oma'. This URN is:

urn:oma:xml:poc:det-progress-rep

The detailed Discrete Media Transfer Progress Report document begins with the root <det-progress-rep> element.

The <det-progress> element consists of number of <leg> elements.

Each <leg> element contains a mandatory "uri" attribute containing the URI of the recipient and

1. a "status" attribute with or without a "max-size" attribute ; or,
2. a "sent" attribute.

If both "status" attribute and "sent" attribute are missing, the <leg> element is ignored.

If the Discrete Media was completely delivered to the Participant or if the Discrete Media delivery to the Participant failed, the <leg> element contains the "status" attribute containing the MSRP status code of the recipient indicated with 'uri' attribute.

If the Discrete Media cannot be sent to the Participant because the Participant has negotiated the SDP attribute "a=max-size" lower than the Discrete Media size, the <leg> element contains the "status" attribute with value "9999" and the "max-size" attribute with the value corresponding to the SDP attribute "a=max-size" negotiated by the Participant indicated with 'uri' attribute.

If the Discrete Media is being delivered to the Participant, the <leg> element contains "sent" attribute indicating the number of bytes successfully delivered to the recipient indicated with 'uri' attribute.

The detailed Discrete Media Transfer Progress Report document shall be identified with the MIME content type "application/vnd.oma.poc.detailed-progress-report+xml".

E.2.2 Structure of optimized Discrete Media Transfer Progress Report

The optimized Discrete Media Transfer Progress Report is an XML document that must be well formed and has to be valid. The optimized Discrete Media Transfer Progress Report document is based on XML 1.0 and uses UTF-8 encoding. This specification makes use of XML namespaces for identifying the detailed Discrete Media Transfer Progress Report document and document fragments. The namespace URI for elements defined by this specification is a URN, using the namespace identifier 'oma'. This URN is:

urn:oma:xml:poc:opt-progress-rep

The optimized Discrete Media Transfer Progress Report document begins with the <opt-progress-rep> element. It consists of four attributes:

lowest-num-bytes-xfer : lowest number of bytes delivered to a receiving PoC Client (i.e. slowest link).

pending : number of legs on which transfer in progress.

done : number of links transfer is completed.

failed : number of links transfer is failed.

The Discrete Media Transfer Progress Report document shall be identified with the MIME content type "application/vnd.oma.poc.optimized-progress-report+xml"

E.2.2.1 Example of detailed Discrete Media Transfer Progress Report

Content-Type: application/vnd.oma.poc.detailed-progress-report+xml

```
<?xml version="1.0" encoding="UTF-8" ?>
```

```
<det-progress xmlns="urn:oma:xml:poc:det-progress-rep">
```

```
  <leg uri="sip:bob1@example.com" sent="1024"/>
```

```

<leg uri="sip:bob2@example.com" sent="512"/>
<leg uri="sip:carol1@example.com" status="200"/>
<leg uri="sip:carol2@example.com" status="200"/>
<leg uri="sip:carol3@example.com" status="200"/>
<leg uri="sip:sally1@example.com" status="408"/>
<leg uri="sip:sally2@example.com" status="9999" max-size="50000"/>

```

```
</det-progress>
```

msg x+1 when there is only a change in bob1@example.com (received already 2000 bytes instead of previously 1024):

Content-Type: application/vnd.oma.xml.poc.detailed-progress-report+xml

```

<?xml version="1.0" encoding="UTF-8" ?>
<det-progress xmlns="urn:oma:xml:poc:det-progress-rep">
    <leg uri="sip:bob1@example.com" sent="2000"/>
</det-progress>

```

E.2.2.2 Example of optimized Discrete Media Transfer Progress Report

Content-Type: application/vnd.oma.poc.optimized-progress-report+xml

```

<?xml version="1.0" encoding="UTF-8" ?>
<opt-progress xmlns="urn:oma:xml:poc:opt-progress-rep"
    lowest-num-bytes-xfer="512"
    pending="2"
    done="3"
    failed="2"/>
</opt-progress>

```

E.2.3 XML Schema for the Discrete Media Transfer Progress Report

E.2.3.1 XML Schema for detailed Discrete Media Transfer Progress Report

The detailed Discrete Media Transfer Progress Report document SHALL conform to the XML schema described in [OMA-PoC-DET-PROG-REP].

E.2.3.2 XML Schema for optimized Discrete Media Transfer Progress Report

The optimized Discrete Media Transfer Progress Report document SHALL conform to the XML schema described in [OMA-PoC-OPT-PROG-REP].

Appendix F. Documentation of Media Types for IANA registration

This appendix contains the information needed for IANA registration. The registration is done on <http://www.iana.org/cgi-bin/mediatypes.pl>.

F.1 Final-Report

MIME media type name: Application

MIME subtype name: Vendor Tree - vnd.oma.poc.final-report+xml

Required parameters: none

Optional parameters: none

Encoding considerations: 8bit

The UTF-8 char set is used in the content of this XML-based media type.

Security considerations: This content type carries the final delivery result of an MSRP message and does not contain information that needs to be kept private.

The vnd.oma.poc.final-report+xml typed content itself does not provide either privacy or integrity protection. If needed external mechanisms such as those suggested by [RFC3428] for SIP MESSAGE bodies may be applied.

This media type does not contain executable content.

Interoperability considerations: This content type provides a format for exchanging information about the result of a sent MSRP message.

Published specification: The OMA PoC User Plane Specification is published at <http://www.openmobilealliance.org/>.

Applications which use this media: Applications that support MSRP, such as OMA Push to Talk over Cellular (PoC) service.

Additional information:

1. Magic number(s) : none
2. File extension(s) : none
3. Macintosh file type code : none
4. Object Identifiers: none

Intended usage: Common

This content type provides a format for exchanging information about the result of a sent MSRP message.

Person to contact for further information:

1. Name : OMA Push to Talk over Cellular (POC) Working Group
2. Email : technical-comments@mail.openmobilealliance.org

Author/Change controller: The OMA PoC specifications are a work item of the OMA Push to Talk over Cellular (POC) Working Group. The Open Mobile Alliance has change control over these specifications, with mailing list address technical-comments@mail.openmobilealliance.org.

F.2 Discrete Media Transfer Progress Report

F.2.1 Detailed progress report

MIME media type name: Application

© 2008 Open Mobile Alliance Ltd. All Rights Reserved.

Used with the permission of the Open Mobile Alliance Ltd. under the terms as stated in this document.

[OMA-Template-Spec-20050101-1]

MIME subtype name: Vendor Tree - vnd.oma.poc.detailed-progress-report+xml

Required parameters: none

Optional parameters: none

Encoding considerations: 8bit

The UTF-8 char set is used in the content of this XML-based media type.

Security considerations: This content type carries a detailed report sent to the sending user equipment to indicate progress of the final delivery result of an MSRP message and does not contain information that needs to be kept private.

The vnd.oma.poc.detailed-progress-report+xml typed content itself does not provide either privacy or integrity protection. If needed external mechanisms such as those suggested by [RFC3428] for SIP MESSAGE bodies may be applied.

This media type does not contain executable content.

Interoperability considerations: This content type provides a format for exchanging information about the result of a sent MSRP message.

Published specification: The OMA PoC User Plane Specification is published at <http://www.openmobilealliance.org/>.

Applications which use this media: Applications that support MSRP, such as OMA Push to Talk over Cellular (PoC) service.

Additional information:

1. Magic number(s) : none
2. File extension(s) : none
3. Macintosh file type code : none
4. Object Identifiers: none

Intended usage: Common

This content type carries a detailed report sent to the sending user equipment to indicate progress of the final delivery result of an MSRP message.

Person to contact for further information:

1. Name : OMA Push to Talk over Cellular (POC) Working Group
2. Email : technical-comments@mail.openmobilealliance.org

Author/Change controller: The OMA PoC specifications are a work item of the OMA Push to Talk over Cellular (POC) Working Group. The Open Mobile Alliance has change control over these specifications, with mailing list address technical-comments@mail.openmobilealliance.org.

F.2.2 Optimized progress report

MIME media type name: Application

MIME subtype name: Vendor Tree - vnd.oma.poc.optimized-progress-report+xml

Required parameters: none

Optional parameters: none

Encoding considerations: 8bit

The UTF-8 char set is used in the content of this XML-based media type.

Security considerations: This content type carries an optimized report sent to the sending user equipment to indicate progress of the final delivery result of an MSRP message and does not contain information that needs to be kept private.

The vnd.oma.poc.optimized-progress-report+xml typed content itself does not provide either privacy or integrity protection. If needed external mechanisms such as those suggested by [RFC3428] for SIP MESSAGE bodies may be applied.

This media type does not contain executable content.

Interoperability considerations: This content type provides a format for exchanging information about the result of a sent MSRP message.

Published specification: The OMA PoC User Plane Specification is published at <http://www.openmobilealliance.org/>.

Applications which use this media: Applications that support MSRP, such as OMA Push to Talk over Cellular (PoC) service.

Additional information:

1. Magic number(s) : none
2. File extension(s) : none
3. Macintosh file type code : none
4. Object Identifiers: none

Intended usage: Common

This content type carries a optimized report sent to the sending user equipment to indicate progress of the final delivery result of an MSRP message.

Person to contact for further information:

1. Name : OMA Push to Talk over Cellular (POC) Working Group
2. Email : technical-comments@mail.openmobilealliance.org

Author/Change controller: The OMA PoC specifications are a work item of the OMA Push to Talk over Cellular (POC) Working Group. The Open Mobile Alliance has change control over these specifications, with mailing list address technical-comments@mail.openmobilealliance.org.